

electronics

FEBRUARY • 1957

PRICE 75 CENTS

Starts This Issue page 4
INDUSTRY REPORT

A M C G R A W - H I L L P U B L I C A T I O N



A Complete image, using NTSC field-test signal specifications



B Successive fields of A, showing effect of phase error



C Monochrome image resulting when chromatic signal is removed from A



D Chromatic image resulting when mono-chrome signal is removed from A

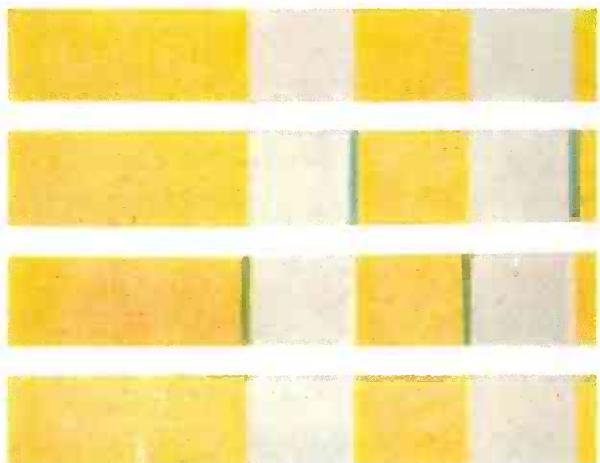

E Yellow and white bars, showing removal of color fringes by color phase alternation



PERMALLOY DUST TOROIDS FOR MAXIMUM STABILITY...

The UTC type HQ permalloy dust toroids are ideal for all audio, carrier and supersonic applications. HQA coils have Q over 100 at 5,000 cycles... HQB coils, Q over 200 at 4,000 cycles... HQC coils, Q over 200 at 30 KC... HQD coils, Q over 200 at 60 KC... HQE (miniature) coils, Q over 120 at 10 KC. The toroid dust core provides very low hum pickup... excellent stability with voltage change... negligible inductance change with temperature, etc. Precision adjusted to 1% tolerance. Hermetically sealed.



HQA, HQC, HQD CASE

1 13/16" Dia. x 1 3/16" High



HQB CASE

1 5/8" x 2 5/8" x 2 1/2" High



HQA CASE

1/2" x 1 5/16" x 1 3/16" High

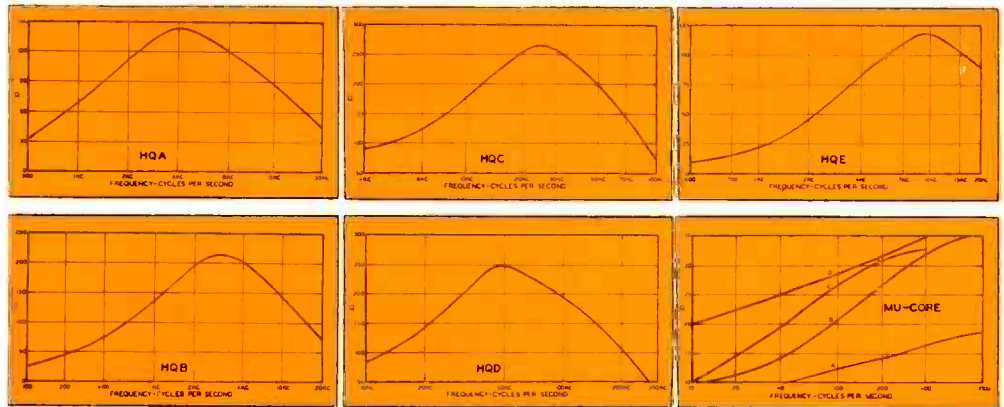

Type No.	Inductance Value	Net Price	Type No.	Inductance Value	Net Price	Type No.	Inductance Value	Net Price
HQA-1	5 mhy.	\$7.00	HQA-16	7.5 hy.	\$15.00	HQC-1	1 mhy.	\$13.00
HQA-2	12.5 mhy.	7.00	HQA-17	10. hy.	16.00	HQC-2	2.5 mhy.	13.00
HQA-3	20 mhy.	7.50	HQA-18	15. hy.	17.00	HQC-3	5 mhy.	13.00
HQA-4	30 mhy.	7.50	HQB-1	10 mhy.	16.00	HQC-4	10 mhy.	13.00
HQA-5	50 mhy.	8.00	HQB-2	30 mhy.	16.00	HQC-5	20 mhy.	13.00
HQA-6	80 mhy.	8.00	HQB-3	70 mhy.	16.00	HQD-1	.4 mhy.	15.00
HQA-7	125 mhy.	9.00	HQB-4	120 mhy.	17.00	HQD-2	1 mhy.	15.00
HQA-8	200 mhy.	9.00	HQB-5	.5 hy.	17.00	HQD-3	2.5 mhy.	15.00
HQA-9	300 mhy.	10.00	HQB-6	1. hy.	18.00	HQD-4	5 mhy.	15.00
HQA-10	.5 hy.	10.00	HQB-7	2. hy.	19.00	HQD-5	15 mhy.	15.00
HQA-11	.75 hy.	10.00	HQB-8	3.5 hy.	20.00	HQE-1	5 mhy.	6.00
HQA-12	1.25 hy.	11.00	HQB-9	7.5 hy.	21.00	HQE-2	10 mhy.	6.00
HQA-13	2. hy.	11.00	HQB-10	12. hy.	22.00	HQE-3	50 mhy.	7.00
HQA-14	3. hy.	13.00	HQB-11	18. hy.	23.00	HQE-4	100 mhy.	7.50
HQA-15	5. hy.	14.00	HQB-12	25. hy.	24.00	HQE-5	200 mhy.	8.00

UTC INTERSTAGE AND LINE FILTERS



FILTER CASE M

1 3/16" x 1 11/16",
1 5/8" x 2 1/2" High

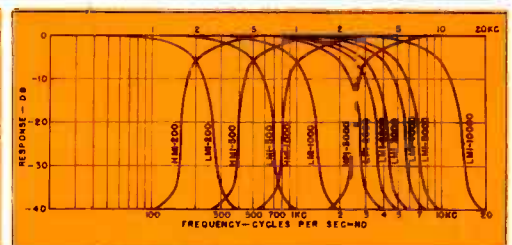
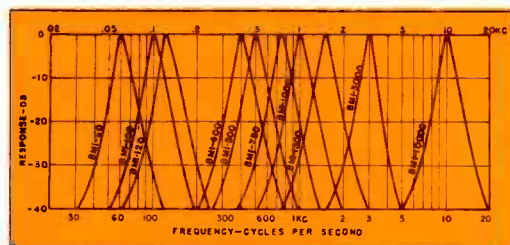

These U.T.C. stock units take care of most common filter applications. The interstage filters, BMI (band pass), HMI (high pass), and LMI (low pass), have a nominal impedance at 10,000 ohms. The line filters, BML (band pass), HML (high pass), and LML (low pass), are intended for use in 500/600 ohm circuits. All units are shielded for low pickup (150 mv/gauss) and are hermetically sealed.

STOCK FREQUENCIES
(Number after letters is frequency)
Net Price \$25.00

BMI-60	BMI-1500	LMI-200	BML-400
BMI-100	BMI-3000	LMI-500	BML-1000
BMI-120	BMI-10000	LMI-1000	HML-200
BMI-400	HMI-200	LMI-2000	HML-500
BMI-500	HMI-500	LMI-3000	LML-1000
BMI-750	HMI-1000	LMI-5000	LML-2500
BMI-1000	HMI-3000	LMI-10000	LML-4000
			LML-12000

United Transformer Co.

150 VARICK STREET

NEW YORK 13, N. Y.

EXPORT DIVISION: 13 EAST 40th STREET, NEW YORK 16, N. Y.

TABLES: "AR AB"

electronics



A
P
U
V
-
H
I
L
L
-
P
U
B
L
I
S
H
I
N
G

FEBRUARY • 1952

NTSC COLOR TELEVISION IMAGES
Color television image photographs taken at laboratories of Hazeltine Corporation to facilitate analysis of Television System Committee signals (see p 88)

INDUSTRY REPORT
ELECTRONICS begins a new monthly service for management men, covering important facts, figures and trends

ELECTRONICS ENGINEERING NEEDED IN MEDICINE, by Herman I. Kantor
A member of the medical profession suggests new jobs for electronics

NEW PENNSYLVANIA TURNPIKE UHF COMMUNICATIONS SYSTEM, by D. N. Lapp
Microwave circuits added to existing vhf system increase utility of Turnpike communications system

PRINCIPLES OF NTSC COMPATIBLE COLOR TELEVISION, by C. J. Hirsch, W. F. Bailey and B. D. Lough
Technical basis of the color television system being field tested by the NTSC

NTSC COLOR-TV SYNCHRONIZING SIGNAL, by R. B. Dome
Proposal for field test provides compatibility with existing monochrome system

VIBRATING-PLATE VISCOMETER, by J. G. Woodward
Thin flat plate immersed in liquid and oscillated is used to measure viscosity

INEXPENSIVE SQUARE-WAVE GENERATOR, by George W. Gray 101
Tester using three tubes produces frequencies from 50 cps to 1 mc for audio and television equipment

R-F BURSTS ACTUATE GAS-TUBE SWITCH, by H. J. Geisler 104
Method of using simple gas diodes as radio-frequency actuated switches for computers and other applications

MORE COLLEGE DEFENSE RESEARCH?, by John I. Mattill 106
Survey shows that faculty, institutions and equipment are still available for more electronics defense research

CONCENTRIC LINES TUNE UHF CHANNELS, by Edward E. Harries and Madison Cawein 108
Edge-mounted metal strips comprise tunable elements for tv channels 14 to 83

MAGNETIC MODULATORS, by E. P. Felch, V. E. Legg and F. G. Merrill 113
Carrier system replaces d-c amplifiers in instrumentation applications

BROAD-BANDING BY STAGGER TUNING, by Roland C. Wittenberg 118
Nomographs and tables simplify design of wide-band radar and television amplifiers

REGULATED 1,600-AMPERE FILAMENT SUPPLY, by A. W. Vance and C. C. Shumard 122
Seven-tube circuit controls firing times of thyatrons in primary legs of transformer

EVALUATING PERFORMANCE OF TV PICTURE TUBES, by Julius Green 124
Accurate measurement of spot dimensions are made under operating conditions

MICROWAVE ANTENNA PATTERN PLOTTER, by John W. Tiley 130
Automatic system takes two minutes to plot complete 180-degree pattern

ATMOSPHERIC ABSORPTION CHART (Reference Sheet), by Arnold Shostak 134
Varying absorption of microwaves and infrared rays by atmosphere is charted for 0.001 mm to 10 cm

CROSSTALK 81 ELECTRONS AT WORK 136 PRODUCTION TECHNIQUES 220 NEW PRODUCTS 270
NEWS FROM THE FIELD 316 NEW BOOKS 330 BACKTALK 341 INDEX TO ADVERTISERS (Last Page)

DONALD G. FINK, Editor; **W. W. MacDONALD**, Managing Editor; John Markus, Vin Zeluff, A. A. McKenzie, James D. Fahnestock, Associate Editors; William P. O'Brien, Ronald K. Jurgen, Assistant Editors; Fred Goldberg, News Editor; John M. Carroll (on Military leave), Ann Mastropolo, Marilyn Wood, Editorial Assistants; Gladys T. Montgomery, Washington Editor; Harry Phillips, Art Director; Eleanor Luke, Art Assistant

KEITH HENNEY, Consulting Editor

H. W. MATEER, Publisher; **WALLACE B. BLOOD**, Manager; R. S. Quint, Buyers' Guide Manager; N. F. Cullinan, Promotion & Research Assistant; H. E. Hilty, Classified Manager; D. H. Miller, James Girdwood, New York; Wm. S. Hodgkinson, New England; Warren W. Shew, Philadelphia; C. D. Wardner, Chicago; J. L. Phillips, Cleveland; T. H. Carmody, R. C. Alcorn, San Francisco; Carl W. Dysinger, Los Angeles; Ralph C. Maultsby, Atlanta



February, 1952

ELECTRONICS

Member ABC and ABP

Vol. 25, No. 2



Published monthly with an additional issue in June by McGraw-Hill Publishing Company, Inc., James H. McGraw (1860-1948), Founder. Publication Office, 99-129 North Broadway, Albany 1, N. Y.

Executive, Editorial and Advertising Offices: McGraw-Hill Building, 330 W. 42nd St., New York 36, N. Y. Curtis W. McGraw, President; Willard Chevalier, Executive Vice-President; Joseph A. Gerardi, Vice-President and Treasurer; John J. Cooke, Secretary; Paul Montgomery, Senior Vice-President, Publications Division; Ralph B. Smith, Editorial Director; Nelson Bond, Vice-President and Director of Advertising; J. E. Blackburn, Jr., Vice-President and Director of Circulation.

Subscriptions: Address correspondence to Electronics—Subscription service, 99-129 N. Broadway, Albany 1, N. Y., or 330 W. 42nd St., New York 36, N. Y. Allow ten days for change of address. Please indicate position and company connection on all subscription orders.

Single copies 75¢ for United States and possessions, and Canada; \$1.50 for Latin America; \$2.00 for all other foreign countries. Buyers' Guide \$2.00. Subscription rates—United States and possessions, \$6.00 a year; \$9.00 for two years. Canada, \$10.00 a year; \$16.00 for two years. Foreign countries, \$15.00 a year; \$25.00 for two years. All other countries \$20.00 a year; \$30.00 for two years. Entered as second class matter August 29, 1936, at the Post Office at Albany, N. Y., under act of Mar. 3, 1879. Printed in U. S. A. Copyright 1952 by McGraw-Hill Publishing Co., Inc.—All Rights Reserved. BRANCH OFFICES: 520 North Michigan Avenue, Chicago 11, Ill.; 68 Post Street, San Francisco 4; Aldwych House, Aldwych, London, W.C. 2; Washington, D. C., 4; Philadelphia 3; Cleveland 15; Detroit 26; St. Louis 8; Boston 16; Atlanta 3, Ga.; 1111 Wilshire Blvd., Los Angeles 17; 738-9 Oliver Building, Pittsburgh 22. ELECTRONICS is indexed regularly in The Engineering Index.

marion "tamper-proof" hermetically sealed running time meter



REGISTERS OPERATING TIME OF
MACHINE TOOLS, ELECTRONIC,
ELECTRICAL OR GENERAL
INDUSTRIAL EQUIPMENT

SPECIFICATIONS

- Registers in 1/10 hour steps to 9999.9 or hour steps to 99999
- Hermetically sealed, glass to metal
- Moisture-proof, dust-proof
- Drawn steel case provides magnetic shielding
- Self-starting synchronous motor
- Moderately priced

Marion's new Running Time Meter is absolutely tamper-proof because it is sealed in a drawn steel case. Designed for a wide range of operating temperatures, it is also ideal for use in hazardous atmospheres. The easy-to-read dial is viewed through tempered glass crystal which is fused directly to the case.

Powered by a durable self-starting synchronous motor, available for 110-125, 220-250 volts . . . 50 or 60 cycle A. C. . . the Marion Running Time Meter occupies no more panel space than an ordinary 3½" meter.

Demands of our national mobilization program come first, of course, but we will gladly supply further information and serve you to the best of our ability.



MARION ELECTRICAL INSTRUMENT CO., 401 CANAL ST., MANCHESTER, N. H.

marion meters

MANUFACTURERS OF MARION



Ruggedized PANEL METERS

THIS INTERESTING QUARTERLY WILL BE MAILED FREE TO ANY PART OF THE WORLD

AUSTRALIA

Messrs. Watson Victor Limited
9-13, Bligh Street,
Sydney, N.S.W.

BELGIUM

Paul Groeninckx,
Avenue Jean Stobbaerts, 43,
Brussels.

CANADA

The J. W. Ellis Industries,
42, Lombard Street,
Toronto.

DENMARK

Ditz Schweitzer,
Norre Voldgade, 48,
Copenhagen, K.

FRANCE

Jacques Pérès Fils,
4, Avenue de l'Opéra,
Paris 1.

HOLLAND

Geo. C. F. Kauderer,
Muiden.

INDIA

Adair, Dutt & Co. (India) Ltd.
5, Dalhousie Square,
Calcutta.

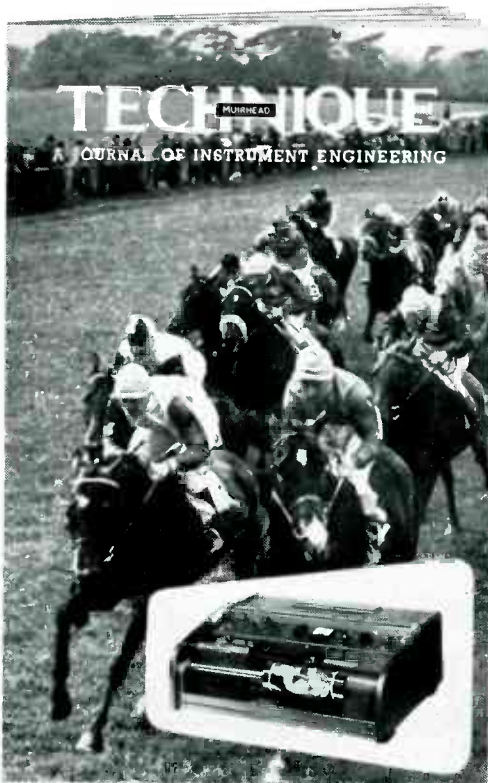

ITALY

Ing. Silvio Garrone,
Piazza Della Marina, 1,
Rome.

NORWAY

J. L. Nerlien A/S,
Nedre Slottsgt 13,
Oslo.

NEW ZEALAND

Richardson, McCabe & Co. Ltd.,
P.O. Box 792,
Wellington.

SOUTH AFRICA

Johnson & Phillips South Africa,
(Pty.) Limited,
P.O. Box 552,
Germiston.

SWEDEN

Ingenjorsfirma Hugo Tillquist,
Nybrokajen 7, Postbox 7026,
Stockholm 7.

SWITZERLAND

Camille Bauer,
Dornacherstrasse 18,
Basel.

U.S.A.

Muirhead & Co. Ltd.,
Elmers End, Beckenham,
Kent, England.

TECHNIQUE IS ALSO PUBLISHED IN FRENCH. IF THIS EDITION
IS REQUIRED, MARK YOUR COUPON "EDITION FRANÇAISE"

FILL IN THIS COUPON AND MAIL TO US OR OUR AGENTS

(SEE LIST ABOVE)

*Please mail me, free of charge,
the quarterly journal
of instrument engineering
"TECHNIQUE,"
published by
Muirhead & Co., Limited.*

NAME _____

POSITION _____

COMPANY _____

ADDRESS _____

ELECTRONICS 59

MUIRHEAD & Co. LTD.
PRECISION ELECTRICAL INSTRUMENT MAKERS
BECKENHAM · KENT · ENGLAND

Telegrams and Cables: MUIRHEADS ELMERS-END

PRECISION

MUIRHEAD

ELECTRICAL INSTRUMENTS

INDUSTRY REPORT

electronics—FEBRUARY • 1952

What It Costs to Build a Television Station

Investments range from modest \$135,000 minimum to cool \$593,500 or more

PEANUTS will not pay for a new television station, even if you get a break on legal and engineering fees and land, add to an existing transmitter building or build a new one as low as \$1.50 per cubic foot and omit fancy fixtures.

Neal McNaughten, director of

powers permitted under the same ruling would be 100 kilowatts on channels 2 to 6 and 200 kilowatts on channels 7 to 13. Complete very-high-frequency television stations using such powers would cost \$593,500 in the first case and \$587,500 in the second, including remote-pickup truck and double-hop microwave relay equipment. Ultra-high-frequency stations, when these are licensed, would cost at least \$1,500 more.

NARTB will soon distribute a booklet titled *Television Construction Costs* to its members. The

"No Electronic Bottlenecks So Far"—NPA

30-months of military equipment production covered by present funds.

ALLOCATION OF MATERIALS to electronic equipment producers is in good shape. So said E. T. Morris and J. A. Milling of NPA and Col. C. A. Poutre of Munitions Board at industry meeting in Washington January 11th. To date no single case of military electronic equipment production stoppage due to shortage of material has been encountered and none is anticipated so long as supply of nickel holds up.

At the electronics meeting, fifth scheduled with press and representatives of large defense industries (others: metals, machine tools, construction, chemicals) it was predicted that in 1952 electronic consumer durables would be down 32 percent below 1951, industrial electronics up 20 percent and military electronics up 165 percent. Even with military running far above the 1951 rate, materials are expected to be available for all needs, except possibly nickel. Nickel supplies seem ample, but processing and distribution, from producer to tube plants, is so complicated that NPA feels some may be lost in the shuffle. Substitution for nickel in components other than tubes must accelerate.

► **Material Allocations**—Other tricky question is the delicate balance between electronic end products and components that go into them. Of all materials allocated except steel, 80 percent now goes into components, 20 percent to end products. In steel, due to consump-

Trends in the News

engineering for the National Association of Radio and Television Broadcasters, has checked with existing stations concerning real-estate and construction costs, and with manufacturers of transmitters and towers. He comes up with these estimates of minimum overall budget:

City (with power and antenna height)	Without Studio	With New Trans. Bldg.	Complete, With Dual Camera Chain
under 50,000 pop. (1 kw, 300 ft*)	\$135,000	\$159,000	\$219,000
50,000-250,000 (2 kw, 500 ft†)	184,750	211,750	274,000
250,000-1,000,000 (10 kw, 600 ft†)	200,000	237,500	299,750
over 1,000,000 (50 kw, 600 ft†)	244,500	292,000	356,250

* Add \$12,500 if tower is self-supporting instead of guyed; † add \$38,500 if tower is self-supporting.

► **Maximum Power More**—McNaughten's conservative figures cover the cost of new television stations using minimum effective radiated powers permitted by the Federal Communications Commission under a new ruling soon to become official policy. Maximum

booklet will break down station costs into individual items, give many more facts useful to existing and potential licensees.

Navy Reports On Electronics Production

TOTAL PRODUCTION of the electronics industry in the current fiscal year (July 1, 1951-June 30, 1952) will reach \$4 billion, says the Office of Naval Materiel, Department of Defense. A report, not yet publicly released, states that planned military production for '52 will represent 58 percent of the total.

A Navy survey of 367 companies engaged in manufacturing electronic equipment shows that large companies estimate 56 percent of total planned production will be for military use; smaller companies will produce 70 percent for the military. Eighty companies are now doing military work exclusively, while 29 report that none of their production is for the armed forces.

INDUSTRY REPORT →

February, 1952 — ELECTRONICS

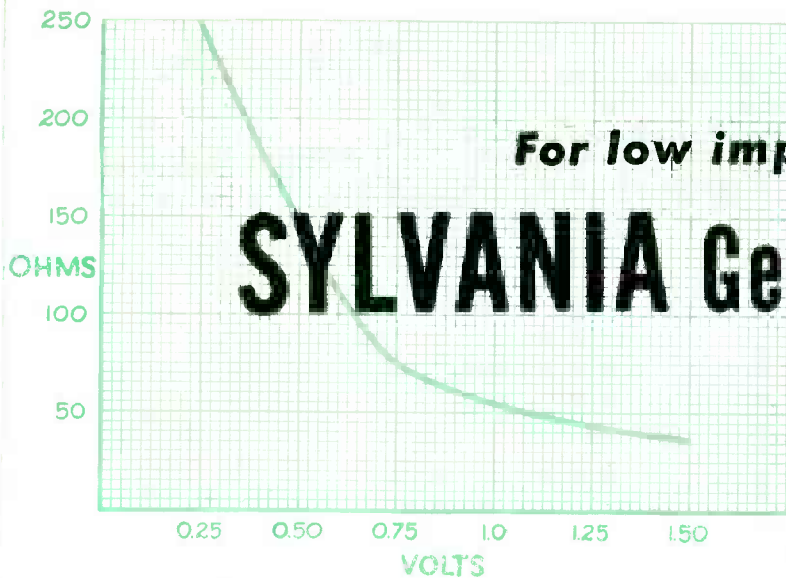

For low impedance applications...

SYLVANIA Germanium Diodes

Typical 1N56 Resistance Characteristic



1N56 DIODE with a potential of +1 volt will pass a current of 15 ma. or more. With a potential of -30 volts, less than 300 μ a. will flow.

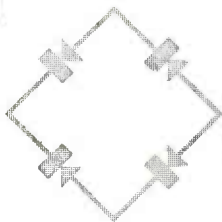

For Carrier Communications

1N71 VARISTOR—The 1N71 consists of 4 matched low impedance diodes each of which, with +1 volt impressed, will pass a current within one ma. of the average current of the four.

All Germanium Diodes are notable for their low forward impedance. But the 1N56 is specially engineered to make the most of this quality.

Use this diode for high efficiency circuits with low input and output impedances. Use it for relay activation, heavy current and surge applications with low impedance coils, transformers and condensers.

Try the 1N71 varistor in carrier telegraphy and telephony work. The low shunt capacitance insures high efficiency throughout the high frequency range. You will find this varistor equally efficient in low impedance modulator circuits of the carrier suppression or carrier transmission type.

Both the 1N56 Germanium Diode and 1N71 Varistor are available from your Sylvania Distributor. Ask him for copies of the two books shown below. Price of each is only 25¢, together they comprise the most complete collection of Germanium Diode applications yet published.



SYLVANIA

ELECTRONIC DEVICES; RADIO TUBES; TELEVISION PICTURE TUBES; ELECTRONIC TEST EQUIPMENT; FLUORESCENT TUBES, FIXTURES, SIGN TUBING, WIRING DEVICES; LIGHT BULBS; PHOTOLAMPS; TELEVISION SETS

Sylvania Electric Products Inc.
Dept. E-2602, Emporium, Pa.

- Please send me "40 Uses for Germanium Diodes." Enclosed is 25¢
- Please send me "Electronic Shortcuts for Hobbyists." Enclosed is 25¢

Name _____

Street _____

City _____ Zone _____ State _____

INDUSTRY REPORT—Continued

tion in chasses, the percentage is about 50-50. Changes in design and in spare-parts orders affect this balance, require careful monitoring.

Relations between NPA and Defense Department are expected to remain harmonious so long as present even keel is maintained. But misunderstandings sometimes arise in industry circles due to conflicting definitions. NPA says an item is electronic if it has electron tubes. Munitions Board figures cover these items as well as everything else in communication and control.

Only about 45 percent of the military dollar goes into radio and radar, (25 radar to 20 radio); 55 percent goes into spare parts and such items as telegraph, telephone, teletype, wire, cable and other non-tube items.

► **Some Contract Lag**—Acknowledged is a lag behind schedule of about 30 percent (dollar value) of electronic production. But a large fraction of this value is not large-scale production, represents cost of services, engineering, and “excessively high” costs of prototype models of radar, sonar and test gear. Largely because engines and other components of aircraft are also behind schedule, the lag in aircraft electronic items has not yet affected delivery of aircraft in quantity. The outlook, moreover, is for a faster makeup of schedule in electronics than in other aircraft items.

► **Second-Quarter Prospects**—Allocations to consumer goods for the second quarter of 1952 were released by DPA same day: communications division gets 43.4 kilotons steel, 43.6 megapounds copper, 2.6 megapounds aluminum; electronics division 58.9 kilotons steel, 30.8 megapounds copper and 12.2 megapounds aluminum. NPA officials hope and expect these amounts can be maintained in third and fourth quarters. If so, 7.5 to 8 million radio sets can be produced during the year with 3.5 to 4-million tv sets, compared with 12.5 million radios and 5.2 million tv sets in 1951.

At the moment NPA knows no method of adjusting allocations to conform to seasonal consumer buying habits. Consequently, to meet

the heavy business (about half the total) which traditionally appears in the last four months, manufacturers will have to put sets in inventory in the spring. NPA points out this gamble is not an unmitigated evil, since steady flow of materials through allocation channels makes for steady employment and loading on plant during the year. But manufacturers, remembering unhappy inventory experience in mid-51, may well wish they could get materials when they know the market is ready, rather than months before.

Actually, in 1951 many radio-tv manufacturers did not consume all materials allocated to them due to slack demand and misunderstanding on extension of allocation to components and materials suppliers. Now, the working of controls is better understood, and a more normal atmosphere prevails. Scare buying is not anticipated if 4 million tv sets can be built this year. Lifting the freeze should keep the market potential at present “reasonably satisfactory” level as soon as new stations take the air.

Expansion of plant is indicated in certificates of rapid tax amortization granted in 1950 and 1951; 216 certificates represented expansions valued at a total of \$165 million. Completed end-product

HIDE-AND-SPEAK MIKE



Miniature radio transmitter used in Hollywood movie studios operates on 50-megacycles. Using a four-foot antenna, which winds around the body, the 2-tube unit is hidden in the clothes of the actor. A receiver located elsewhere on the set picks up the actor's words, feeds them to a magnetic-tape recorder

plants took 77 of these for \$90 million, tube plants 51 for \$49 million, components 60 for \$23 million, remainder miscellaneous.

► **Future Outlook**—The future health of the electronics industry is bound up in analysis revealed for first time at the meeting: the backlog of military electronic production now amounts to 20 months at the 1952 going rate of production, and a further 10 months of production contracts remains to be let on currently available funds. With 30 months military work ahead, and a near-normal year in radio-tv production, the outlook can only be labelled—good.

New Index of Electronics Output

Manhour and productivity barometer reading to be published monthly (see page 8).

BEGINNING with this issue, a new index of the overall output of the electronics industry will be published monthly in ELECTRONICS for the guidance of businessmen in this field. The monthly service, developed by the editors and the McGraw-Hill Economics Department, covers the production of radio and television receivers, commercial radio and television equipment, military radio and radar equipment, electronic equipment and components, and communications equipment. It will appear regularly on the ‘Figures of the Month’ page (p 8).

The output index is computed from monthly figures collected by the Bureau of Labor Statistics on the number of production workers employed in the electronic fields named above, and the average weekly hours worked. The index figure is the product of these numbers, adjusted for average increase in productivity, which is taken as 8 percent per year. The average of the monthly indexes for 1947 is taken as 100 percent. On this basis, the current index based on the

INDUSTRY REPORT →

February, 1952 — ELECTRONICS

...for **250°C**
CONTINUOUS
OPERATION



Cerroc T

HIGH-TEMPERATURE MAGNET WIRE

A most important aid in the miniaturization of small transformers, reactors, relays, and other copper-wound components of electronic equipment and aircraft! That's the rapidly spreading story about CEROC T, the new and important development in magnet wire.

The first and only magnet wire to operate safely at a continuous temperature of 250°C., Sprague CEROC T wire has considerably higher current ratings than conventional magnet wires of equivalent AWG size. Consequently, you can use smaller sizes of CEROC T to achieve a considerable saving in the physical dimensions and weight of small electric apparatus.

Or if it is necessary to "beef up" equipment already designed to fit a certain space, you can switch to CEROC T windings for a marked increase in electrical rating.

CEROC T Magnet Wire is made by an exclusive, patented Sprague process for applying its insulation of inorganic ceramic and Teflon. It has excellent solvent and abrasion resistance and high dielectric strength. Complete specifications are yours for the asking in Engineering Bulletin 402F.

UP TO 200°C.—CEROC 200 — This ceramic-silicon coated wire is your best choice for operating temperatures up to 200°C. Write for Bulletins 401 and 403B.

SPRAGUE

PIONEERS IN

ELECTRIC AND ELECTRONIC DEVELOPMENT

SPRAGUE ELECTRIC COMPANY
NORTH ADAMS, MASSACHUSETTS

SAVE making all these expensive soldered connections

by using **Centralab** Printed Circuits instead!

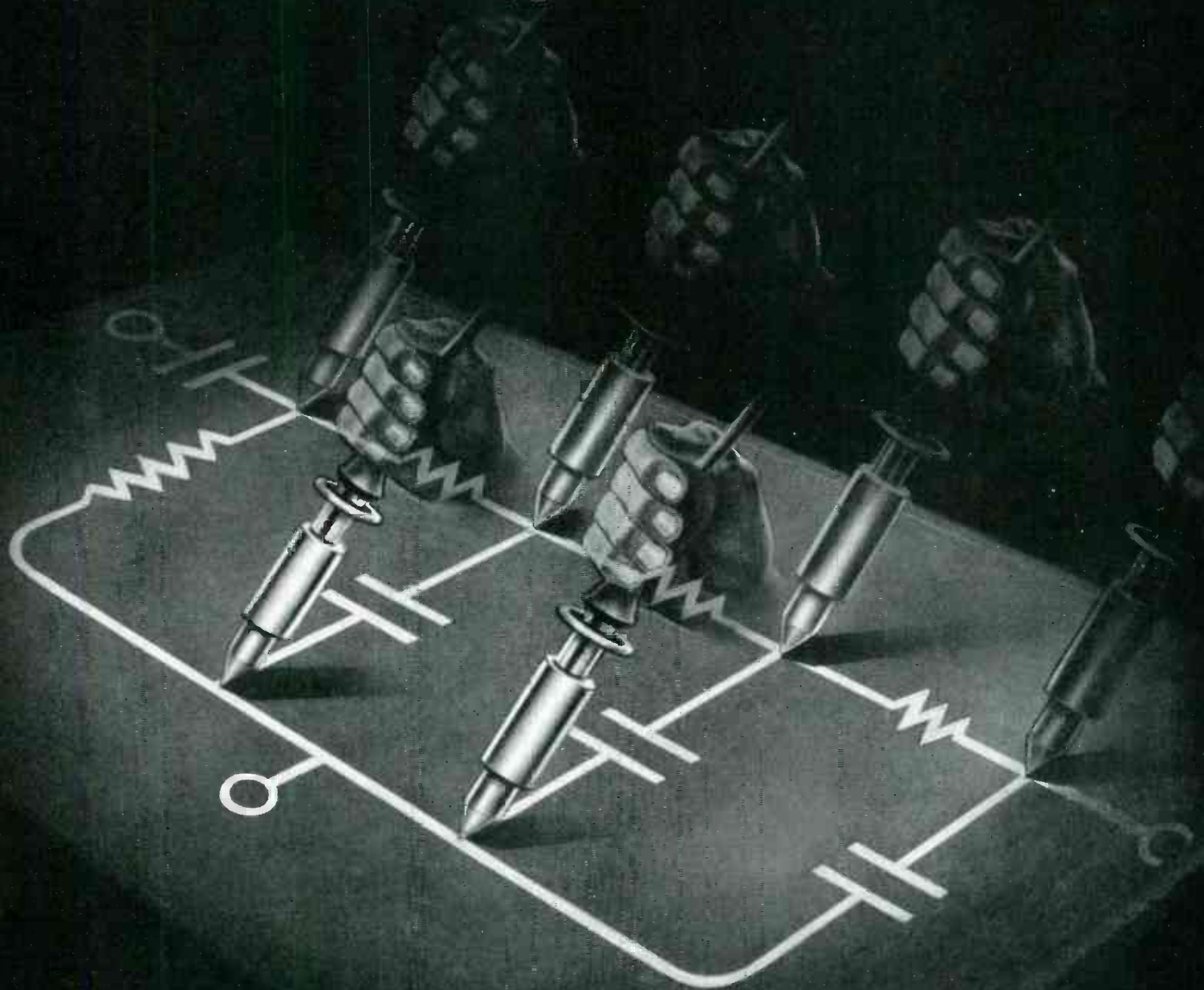

for more information... see the next two pages ▶▶▶











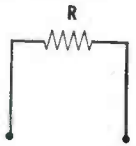

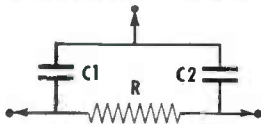

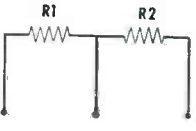

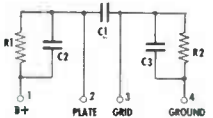

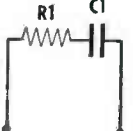

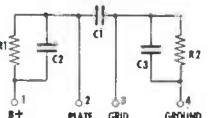

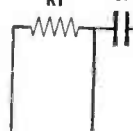

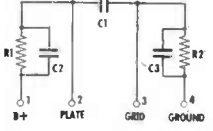
HERE ARE THE STANDARD PRINTED

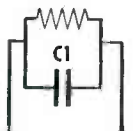
PRINTED ELECTRONIC CIRCUITS

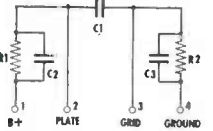
P.E.C. are complete or partial circuits (including all integral circuit connections), consisting of pure metallic silver and resistance materials fired to Centralab's famous Steatite or Ceramic X and brought out to convenient, permanently anchored leads.

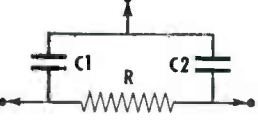
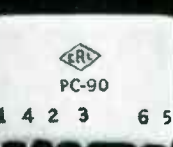
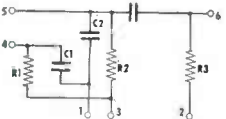
They provide miniature units of widely diversified circuits — from single resistor plates to complete speech amplifiers.

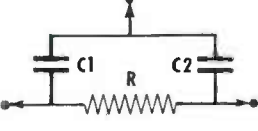
All those illustrated here are available for standard applications. Save these pages for reference. Numerous other circuit complements can be furnished for volume requirements.

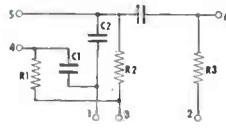
	 <p>PC-2 SINGLE RESISTOR Send for Bulletin 42-24</p> <p>$R=2 \text{ Meg}$</p>		 <p>PC-52 FILPEC Send for Bulletin 42-24</p> <p>$R=47K$ $C_1=50 \text{ mmf.}$ $C_2=50 \text{ mmf.}$</p>
	 <p>PC-21 DUAL RESISTOR Send for Bulletin 42-24</p> <p>$R_1=500K$ $R_2=110K$</p>		 <p>PC-70 MIDGET COUPLATE Send for Bulletin 42-127</p> <p>$R_1=500K$ $R_2=500K$ $C_1=5000 \text{ mmf.}$ $C_2 \text{ plus } C_3=250 \text{ mmf.}$</p>
	 <p>PC-30 RESISTOR-CAPACITOR Send for Bulletin 42-24</p> <p>$R_1=240K$ $C_1=1000 \text{ mmf.}$</p>		 <p>PC-71 MIDGET COUPLATE Send for Bulletin 42-127</p> <p>$R_1=250K$ $R_2=500K$ $C_1=5000 \text{ mmf.}$ $C_2 \text{ plus } C_3=250 \text{ mmf.}$</p>
	 <p>PC-33 RESISTOR-CAPACITOR Send for Bulletin 42-24</p> <p>$R_1=1 \text{ Meg.}$ $C_1=1000 \text{ mmf.}$</p>		 <p>PC-80 STANDARD COUPLATE Send for Bulletin 42-127</p> <p>$R_1=500K$ $R_2=500K$ $C_1=.01 \text{ mfd.}$ $C_2 \text{ plus } C_3=250 \text{ mmf.}$</p>
	 <p>PC-36 RESISTOR-CAPACITOR Send for Bulletin 42-24</p> <p>$R_1=100K$ $C_1=100 \text{ mmf.}$</p>		 <p>PC-81 STANDARD COUPLATE Send for Bulletin 42-127</p> <p>$R_1=250K$ $R_2=500K$ $C_1=.01 \text{ mfd.}$ $C_2 \text{ plus } C_3=250 \text{ mmf.}$</p>
	 <p>PC-50 FILPEC Send for Bulletin 42-24</p> <p>$R=47K$ $C_1=100 \text{ mmf.}$ $C_2=100 \text{ mmf.}$</p>		 <p>PC-90 PENTODE Send for Bulletin 42-128</p> <p>$R_1=4.7 \text{ Meg.}$ $R_2=1 \text{ Meg.}$ $R_3=2.2 \text{ Meg.}$ $C_1=5000 \text{ mmf.}$ $C_2=50 \text{ mmf.}$ $C_3=2000 \text{ mmf.}$</p>
	 <p>PC-51 FILPEC Send for Bulletin 42-24</p> <p>$R=47K$ $C_1=150 \text{ mmf.}$ $C_2=150 \text{ mmf.}$</p>		 <p>PC-91 PENTODE Send for Bulletin 42-128</p> <p>$R_1=4.7 \text{ Meg.}$ $R_2=1 \text{ Meg.}$ $R_3=2.2 \text{ Meg.}$ $C_1=5000 \text{ mmf.}$ $C_2=100 \text{ mmf.}$ $C_3=5000 \text{ mmf.}$</p>

CIRCUIT PLATES ALREADY TOOLED FOR YOU

IMAGINE THE SAVINGS YOU GET WITH THESE CENTRALAB PRINTED ELECTRONIC CIRCUITS!

- Many less soldered connections
- Fewer pieces to buy or inventory
- Far less handling costs
- Fewer wiring errors
- Less weight and smaller space
- More uniform circuitry

When you check the details of standard circuits — each available in one simple component — you'll see the savings in Centralab's Printed Electronic Circuits.

You'll see how they save weight and space. You'll see how several components are replaced by one, saving time and errors in wiring — reducing your component inventory, and how the uniformity of Printed Electronic Circuits assures you of circuit stability between component parts.

That's why more and more electronic design engineers will tell you that *no other low power electronic development offers more time and cost saving advantages than Centralab Printed Electronic Circuits.*

If none of the standard plates meets your requirements, submit your circuit to our engineering department. We can usually design a special plate for your particular needs, at nominal cost.

Check Printed Circuit advantages now. More information and details will be mailed to you right away; — just fill out the coupon below.

Industrial Electronic Parts Distributors carry many of these plates in stock.

Centralab

Division of GLOBE-UNION INC. • Milwaukee 1, Wis.

Centralab, Div. of Globe-Union Inc.
914 East Keefe Avenue, Milwaukee 1, Wisconsin

Please send me the Technical Bulletins on Printed Electronic Circuits as checked below:

- 42-24 42-117 42-126 42-127 42-128
- 42-129 42-130 42-131 42-149

Name.....

Address.....

Company.....

Title.....

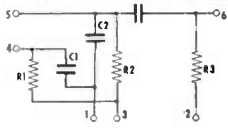
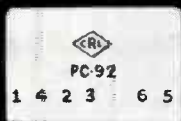

PC-92
PENTODE
Send for
Bulletin 42-128

R₁=4.7 Meg. C₁=5000 mmf.
R₂=1 Meg. C₂=100 mmf.
R₃=2.2 Meg. C₃=2000 mmf.

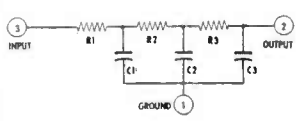

PC-100
VERTICAL
INTEGRATOR
Send for
Bulletin 42-126

R₁=22K C₁=2000 mmf.
R₂=8.2K C₂=5000 mmf.
R₃=8.2K C₃=5000 mmf.

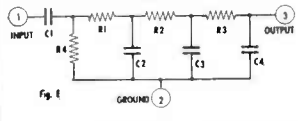

PC-101
VERTICAL
INTEGRATOR
Send for
Bulletin 42-126

R₁=22K C₁=.01 mfd.
R₂=8.2K C₂=2000 mmf.
R₃=8.2K C₃=5000 mmf.
R₄=22K C₄=5000 mmf.

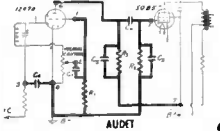
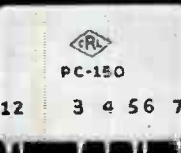

PC-150
AUDET
OUTPUT STAGE
Send for
Bulletin 42-129

R₁=6.8 Meg. C₁=2000 mmf.
R₂=470K C₂=220 mmf.
R₃=470K C₃ plus C₄=250 mmf.
C₄=5000 mmf.

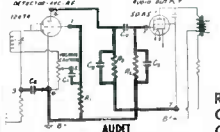

PC-151
AUDET
OUTPUT STAGE
Send for
Bulletin 42-129

R₁=6.8 Meg. C₁=2000 mmf.
R₂=470K C₂=220 mmf.
R₃=470K C₃ plus C₄=250 mmf.
C₄=5000 mmf.

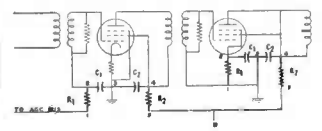

PC-110
FILTRATE
FILTER PLATE
Send for
Bulletin 42-131

R₁=1000 ohms C₁=5000 mmf.
R₂=820 ohms C₂=5000 mmf.

Filtrates as connected in TV I.F. circuits

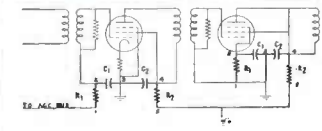

PC-111
FILTRATE
FILTER PLATE
Send for
Bulletin 42-131

R₁=220 ohms C₁=5000 mmf.
R₂=1000 ohms C₂=5000 mmf.

Filtrates as connected in TV I.F. circuits

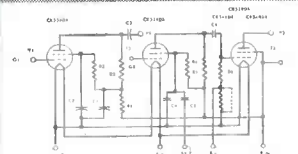

Model 3
AMPEC
Send for
Bulletin 42-130

R₁=.75 meg. R₄=3.3 meg.
R₂=3.3 meg. R₅=1.5 meg.
R₃=1.5 meg. R₆=10 meg.

C₁=3000 ohms
C₂=0.02 mf.
C₃=0.005 mf.
C₄=0.001 mf.
C₅=0.0002 mf.
C₆=0.005 mf.
C₇=0.001 mf.

INDUSTRY REPORT—Continued

October 1951 BLS figures is 142.8 percent, or 42.8 percent above the 1947 base.

To show the trend, the index is plotted from January 1947 to the present, and a new figure is added as each issue goes to press.

The index is not adjusted for seasonal variations and long-term trend. These latter adjustments may be incorporated when the necessary experience is accumulated.

► **Significance Of Output**—The most significant indication of the state of health of the electronics industry is production of wealth, as measured by the output of all plants in the field. Three possible measures of output are: the number of units produced, the dollar value of shipments, and the man-hours worked at a known level of productivity. Physical output figures are hard to come by; most military production figures are classified. Dollar values are not a good index of production activity because price changes are frequent, and are almost impossible to follow statistically. So manhours was chosen as the basis of the Electronics Output Index.

Output is closely geared to man-hours worked, provided that productivity is taken into account. The data on manhours are accurate, taken from the broadest available industrial basis, the BLS monthly report in this field. Moreover the figures are timely, usually not more than seven weeks behind ELECTRONICS' publication date. Finally, an index based on manhours is the most sensitive of all production measures. The instant a change in production is put into effect, man-hours increase or decrease accordingly. Shipments and prices reflecting the change may lag many weeks or months.

► **Weighting of Figures**—The choice of manhours as a basis automatically provides the proper weighting for the various branches of the industry. Obviously the production of 1,000 tv sets is more important than the production of 1,000 receiving tubes, but the man-hours worked in the two cases tend to reflect the difference. For example, in 1950, 67.8 percent of electronic production manhours were

EDISON'S 105TH



The 105th anniversary of Thomas Alva Edison's birth is being celebrated this month throughout the world. Edison is hailed as the founder of the science of electronics. Shown above is the inventor with diode tube in which he discovered electron conduction, basis of all subsequent electronic development

worked in producing radio sets and allied equipment; 17.4 percent electron tubes, 12.8 radio communication, telephone and telegraph equipment, and 2 percent other communications equipment. Changes in these categories occur,

but are averaged out in the overall manhour and productivity figures. The year 1947 was chosen as the base of the index because the last complete census of manufacturers was taken in that year, and because it represents a typical post-war, pre-Korea year.

One possibility of error exists which cannot, for the time being, be recognized in the index. The BLS figures are taken from established electronic firms, doing peacetime as well as war production business. Currently many firms outside the traditional boundaries of the electronics industry, such as milling companies, sparkplug producers, etc, are accepting contracts for production of electronic war items. The production workers of such firms are not reported by the BLS under the electronics category and their contribution to the overall output is accordingly not reflected. At present the error is negligibly small but it may become larger as more such extra-industry contracts are let. The editors are maintaining close touch with NPA and DPA officials to follow this trend and will publish corrective information as it is released by the war production authorities.

Government Actions

Vast TV Expansion Ready for FCC Nod

Applications for new stations expected to flood Commission as defreeze approaches

NEARLY a billion dollars is ready to be invested in new television broadcast stations, according to FCC Chairman Coy, waiting only the go-ahead from two agencies. First, the FCC must issue its long-awaited report on television expansion, setting up new allocations and rules for vhf and uhf stations. Second, NPA's Industrial Expansion Division must allot critical materials, particularly structural steel for buildings and towers.

The first step, lifting the freeze, has been promised regularly every

six months since issuance of construction permits was discontinued in September 1948. Now, 40 months later, Pandora's Box is to be opened, but wide. On hand in the Commission offices at presstime were 476 applications for new tv stations, 27 of them for uhf. At least 1,000 additional applications were expected to follow closely on the announcement that FCC is again handing out permits. Taking the total investment in a new tv station at NARTB's average estimate of \$250 thousand, 1,500 applications add up to the tidy sum of \$375 million. And this is only the beginning. Two thousand stations are planned for.

► **Allocations Report**—Release of the FCC report is expected before March 1st, may even occur before

INDUSTRY REPORT →

ALL-METL BARRYMOUNTS
Available for Unusual
Airborne Applications



These Barrymounts give the aircraft and electronic engineer a vibration isolator designed to meet the unusual temperature and environmental conditions met in high-altitude, high-speed flight. Using no organic compounds, these mountings are not subject to temperature influences that may affect the performance of other mountings.

ALL-METL Barrymounts have wide load range with uniform performance. Natural frequency is about $7\frac{1}{2}$ cycles per second; horizontal stiffness is low for maximum isolation of horizontal vibration. Transmissibility at resonance is only $4\frac{1}{2}$. There is no snubber contact nor resonance carryover when vibrated at government-specified amplitudes.

Designed especially for unusual military conditions, these mountings meet the vibration requirements of JAN-C-172A, MIL-E-5272 (USAF), and MIL-T-5422 (BuAer). Ask for your free copy of Catalog 509, containing details of these mountings.

**BARRY RUGGEDIZES
ISOLATORS AND BASES**
For Aircraft Carrier Service
and Crash Landings

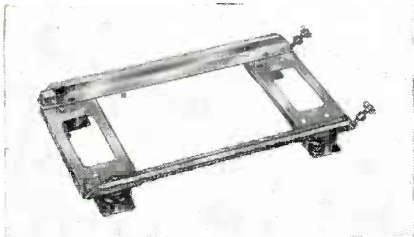

Barry vibration isolators and mounting bases are available in "ruggedized" construction, to withstand the severe shocks of arrested landings on aircraft carriers and in crash landings. These units are tested to meet the shock-test requirements of Specification AN-E-19, for the equipment sizes listed in JAN-C-172A.

Ruggedized mounting bases equipped with either ALL-METL or Air-damped Barrymounts can be furnished in standard JAN-C-172A sizes and in special sizes to meet customers' requirements. A conspicuous advantage of ruggedized Barry bases is the gain in strength of the base framework itself — beyond JAN requirements — achieved with very little increase in weight, for loads up to 50 pounds, by design modification of standard JAN bases. For greater loads, ruggedized Barry bases are of stainless steel instead of aluminum. Write for listing of ruggedized bases and unit mounts.

SHOCK and VIBRATION NEWS

BARRYMOUNTS FOR ASSURED CONTROL OF SHOCK AND VIBRATION



the *Right* answer

TO YOUR SHOCK AND VIBRATION PROBLEMS

will be found in this complete family of Barrymounts. From tiny, ounce-rated unit mounts . . . through ruggedized bases . . . to heavy-duty isolators for industrial machinery . . . Barrymounts meet all your needs. FREE CATALOGS give you details of dimensions, load ratings, and military specifications met by these effective vibration and shock isolators.

FOR AIRCRAFT SERVICE

Catalog 509 describes ALL-METL Barrymounts for use at extreme temperatures. Catalog 502-A covers Air-damped unit mounts and bases.

FOR INDUSTRIAL USES

Catalog 504-B describes the general line of Barrymounts rated from $\frac{1}{8}$ ounce to 3300 pounds. Catalog 607 covers the use of Barrymounts with heavy industrial machinery.

And for SPECIAL PROBLEMS

ask the advice of our Field Engineering department, organized to apply our wide experience to your particular needs.

Address all inquiries to:

THE **BARRY** CORP

707 PLEASANT ST., WATERTOWN 72, MASSACHUSETTS

SALES REPRESENTATIVES IN

Atlanta Chicago Cleveland Dallas Dayton Detroit Los Angeles
Minneapolis New York Philadelphia Phoenix Rochester St. Louis
San Francisco Seattle Toronto Washington

this issue of *ELECTRONICS* reaches subscribers. In the report will appear these items:

♦ A geographical assignment of the 12 existing vhf channels and 70 new uhf channels to 1,250 cities and towns.

♦ The engineering standards of allocation. These are expected to follow recommendations of such professional advisory bodies as JTAC and to meet with general approval of technicians.

♦ A decision on the controversial issue of reserving channels for educational institutions not now financially able to apply for them.

♦ Action on the proposed allocation plans submitted by Allen B. DuMont and others which will have a far-reaching effect on the competitive positions of tv networks.

Behind the report is a vast amount of work by FCC engineers and clerical staff. Already solved is the critical problem of fitting in stations in the crowded New England area, first region set up for consideration. Tentative solutions for other populous regions have also been reached, but a sharp reduction in clerical staff, following recent budget cuts, has curtailed the paperwork follow-through.

► **Licensing Action** — Following issuance of the report, a period of about 60 days is anticipated to allow applicants to revise their applications (from uhf to vhf or vice versa, change in location, etc). During this period the Commission will probably not act on any application and all those from a given city will be placed on equal footing. A firm cutoff date is expected at the end of this filing period; broadcasters filing thereafter will probably find themselves in the second balcony.

The Commission will then take up applications and act on the merits of each. First to be settled will be the easy cases where the number of applications from a given city does not exceed the number of channels reserved for that city. These are smaller communities with limited capital and low market potential.

Next will follow a long series of competitive hearings, during

which the Commission must sort out the haves from the have-nots where applications exceed facilities. Complicating this procedure will be the existence of uhf and vhf assignments in the same area, with substantial difference in coverage and, hence, competitive advantage. Of the 1,985 station assignments planned in the tentative allocation released last year, 526 are for commercial vhf, 1,250 for commercial uhf, 82 for educational vhf, and 127 for educational uhf. It is expected that this division will hold in the final allocation, with a possibility of a reduction in the educational reservations.

Two major hazards confront the industry in the competitive phase of allocation. First, any courageous or foolhardy applicant may throw the whole plan into the courts via the injunction route. Such action, which might delay competitive hearings a year or more, is not expected from established operators. But there is much new money waiting to be invested in a highly profitable business, and a disappointed applicant may dare the Commission's wrath by appeal first to the district courts and ultimately to the Supreme Court. The networks are holding their breath over this possibility because they, as well as the Commission and the public, have no stomach for further delay.

The second hazard is the shortage of hearing examiners. Only seven are now available; the Com-

mission has already gone to Congress for funds to hire an additional seven men for this rough service.

► **UHF and Materials**—The fate of the uhf band is cloudy at the moment. The Commission is fearful that many uhf channels may go begging, due to lack of receiving equipment, if manufacturers hold back waiting for stations to start operation. The industry is banking, therefore, on strong Commission support for the uhf applicant, even to the extent of allowing broadcasters who already own the legal limit of five vhf stations to own several additional uhf outlets.

FCC Broadcast Division Chief Curtis Plummer stands on his earlier prediction that from 50 to 80 uhf or vhf stations will be authorized in smaller non-competitive markets by the first of July, and that an equal number will be issued quarterly thereafter. It is problematical whether NPA actions on steel allotments and other materials controls would provide for new stations at this rate. Certainly if grants were issued faster shortages could take control in a big way. Even if they do, Commissioner Sterling is betting that operators will get on the air somehow, mit ersatz maybe, but on the air. He points out that uhf antennas are small and can be supported temporarily on wooden poles if need be.

So, this spring, tv is off to the races.

Markets and Sales

Lake Carriers Buying VHF Radiophones

GREAT LAKES 'bulk carriers' such as ore, coal, pig iron and limestone ships are installing very high frequency radiophones to supplement equipment now operating on overcrowded medium and high-frequency bands.

The Electronics Committee of the Lake Carriers Association, following a recommendation of the Wash-

ington consulting firm of Jansky & Bailey, is urging ship operators to buy 30 eight-channel sets working in the vicinity of 160 megacycles. Operators have already ordered 19 and installed several, will buy more if the sets pan out satisfactorily in 1952.

► **318 Prospects**—There are 318 bulk carriers under U. S. Registry in the Great Lakes. Of these, 314 are equipped with radiophones op-

INDUSTRY REPORT →

Capacity



**COMES
IN
MANY
SIZES**



Whether you're talking in the simple terms of drinking water . . . a drink for yourself . . . the needs of a construction crew . . . or designing the latest in electronics equipment . . . capacity is important on every job. El-Menco Silvered-Mica Capacitors meet exacting requirements over a wide range . . . from the tiny CM-15 (2-525 mmf. cap.) to the mighty CM-35 (3300-10000 mmf. cap.).

The safety factor of a half-filled jug is built into every El-Menco Capacitor. Each unit is factory-tested at *double* its working voltage. You are assured of dependability in every application. El-Menco Capacitors offer peak performance for all specified military capacities and voltages.

For higher capacity values — which require extreme temperature and time stabilization — there are no substitutes for El-Menco Silvered-Mica Capacitors.

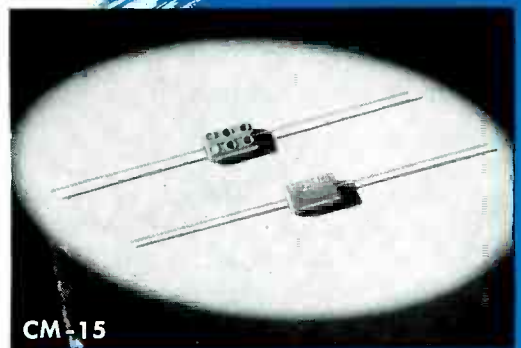

CM-15

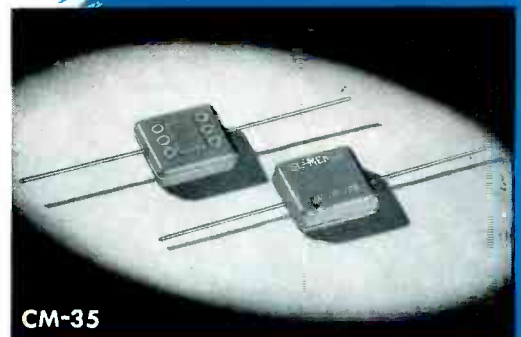

CM-35



Write on your business letterhead
for catalog and samples.

Joiners, Retailers, Distributors—For information communicate direct with Arco Electronics, Inc., 103 Lafayette St., New York, N. Y.

MOLDED MICA **El-Menco** MICA TRIMMER CAPACITORS

Radio and Television Manufacturers, Domestic and Foreign, Communicate Direct With Factory—

THE ELECTRO MOTIVE MFG. CO., INC.

WILLIMANTIC, CONNECTICUT

INDUSTRY REPORT—Continued

erating in the 2, 4, 6 and 8 megacycle medium and high-frequency bands. Aside from interference caused by ships operating in close proximity to each other on these bands, the frequencies involved cause signals to travel much greater distances than are normally needed and so cause additional interference.

New and supplemental vhf radiophones are expected to cover approximately 60 miles from ship to shore and 40 miles from ship to ship. About 75 percent of all bulk-carrier communications, says the Committee, is confined to those ranges.

Printed Circuits— Past, Present and Future

'50 was a development year, '51 brought pilot-plant runs, '52 may see mass production

PRINTED CIRCUITS were the subject of intensive research and development in many plants in 1950. The work had progressed far enough by 1951 to warrant pilot-plant runs. The year 1952 will see the beginning of mass production, and proponents think that by 1953 printed circuits will be used in a substantial number of electrical as well as electronic products.

Military interest sparked print-

ed-circuit research during World War II. Contrary to popular opinion, however, the Services have since then ordered cautiously, with the result that in the postwar period commercial applications have accounted for most of the modest volume. The market is now in the process of reversing, with military contracts constituting over half the business on the books.

► **Broad Field**—The words 'printed circuits' cover many processes and in several instances are a misnomer. There are numerous ways of reducing labor and material costs involved in the use of individual wires and soldered joints in electrical and electronic apparatus. Conductive liquids or powders containing metal such as silver can be deposited in required patterns on plastic or ceramic insulation by 'silk screen' methods commonly used in the manufacture of nameplates. Similar 'wiring' can be printed by means of more or less conventional presses. Insulating materials can be electroplated with metals such as copper, and part of the metal chemically etched away by photo-engraving. Or sheets of metal can be stamped or laminated firmly into plastics and unwanted areas mechanically cut out by means of dies.

In general, silk screening and printing methods are used where only a small amount of electric current must be carried and ex-

treme compactness is the paramount need. Stamping and lamination are more commonly found in heavier-duty electrical equipment. Several mechanized-wiring techniques are used in the fabrication of component parts, as in the internal connections of a multi-contact rotary switch. Some parts such as resistors and capacitors may be printed right along with wiring. Subassemblies such as amplifiers involving printed or stamped wiring and components may form part of large units otherwise wired by conventional means. Dip soldering is frequently used for interconnection of such units. On the other hand, some relatively simple devices such as hearing aids may utilize mechanized-wiring exclusively.

► **Typical Users**—Avion Instrument Corp. thinks it will produce \$25,000 worth of printed or stamped circuits in 1952.

Centralab, reporting "a substantial increase in orders" for 1952, thinks '53 will be "the big year", speculates that printed-circuit business may stack up in about this order of importance for most manufacturers: ordnance items including guided missiles, communications equipment and radar, computers, tv subassemblies and other electronic items.

Decimeter, Inc., using copper-laminated wiring in a two-tube television preamplifier for the past two years, hopes to have the technique approved for use in connection with a government contract.

Elm Laboratories has spent \$10,000 developing a lamination process, is now in production on a pocket-size test instrument, also has a military contract, hopes to get its investment back in '52.

Emeloid expects a 10-time increase this year in orders for both component parts and subassemblies using mechanized-wiring techniques, has commitments that seem to insure it.

Erie Resistor, so far supplying printed circuitry largely for hearing aids, says tv manufacturers are finally taking a more serious look at the technique and that this forecasts a sharp increase in

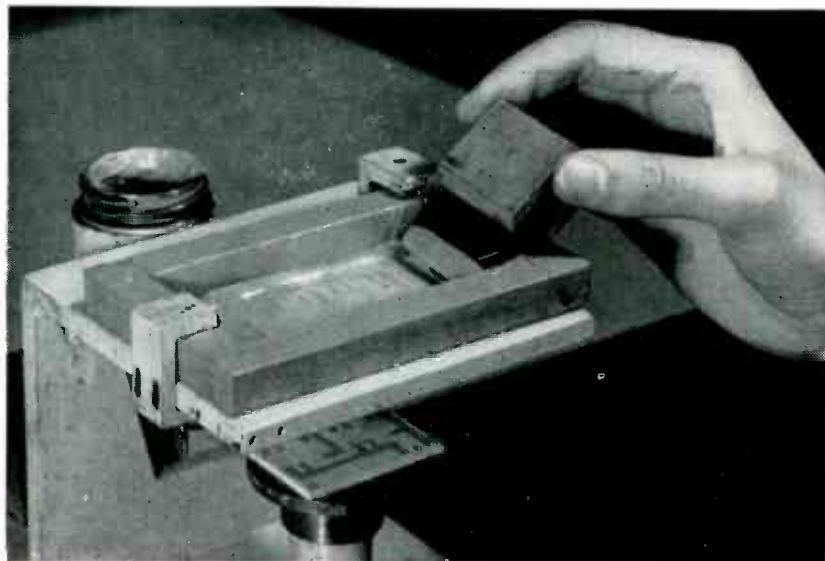

Printed-circuit technique, in elemental form; silk-screen process

NOW FOR SPECTROPHOTOMETER



AN ISOTRONIC DC POWER SOURCE

ACCURATE TO $\pm 0.01\%$

Model E-6/2-5

The best of spectrophotometers operates erratically when input power looks like this

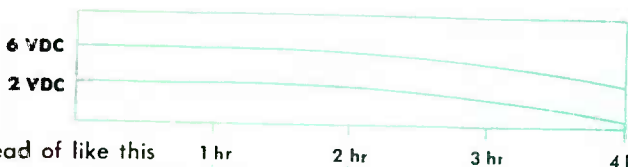

instead of like this



Haven't you been plagued by input voltage drop, particularly in the course of long-running experiments? Or have you had to interrupt or defer work while batteries were being charged or replaced?

The Sorensen Model E-6/2-5 Nobatron* has been specifically designed to exclude this difficulty. Using it, you can be sure your equipment is getting 2 and 6 volts DC, plus or minus 0.01%, with that accuracy maintained indefinitely at normal room temperature.

Furthermore, circuitry developed for the Model E-6/2-5 Nobatron is advanced in simplicity, involving no moving parts. That means easy maintenance, trouble-free operation.

Write for information.

SPECIFICATIONS

Input voltage range	95-130VAC, 1 ϕ , 50-60 cycles
Output	
#1 for lamp	6VDC adjustable $\pm 10\%$ at 5 amperes
#2 for filament	6VDC at 100 Ma.
#3 for bias	2VDC adjustable $\pm 10\%$ at 100 Ma.
Filtering	
#1	1% max.
#2 & 3	0.05% max.
Regulation accuracy	$\pm 0.01\%$ against line changes
Time constant	0.1 seconds under most severe line changes

Size: 17 x 12 $\frac{1}{4}$ x 17 self contained
19 x 12 $\frac{1}{4}$ panel for relay rack mounting

Weight: Approximately 90 pounds

Meters: No meters are provided due to the extreme regulation accuracy involved.

*Reg. U. S. Pat. Off. by Sorensen & Co., Inc.

FOR THE LATEST AND BEST IN ISOTRONICS . . .



Specify

SORENSEN

SORENSEN AND COMPANY • 375 FAIRFIELD AVE., STAMFORD, CONN.

INDI type of business.

Klin Airloop did \$400,000 of stamped wiring business in 1951, says "the prospect for 1952 looks particularly bright in that Sylvania has signed a non-exclusive license agreement."

Mallory, working on a powdered-metal technique, "expects to bring out at least one important new product for the general consumer this year", has a high-priority military contract that appears to lend itself to printed wiring.

Photocircuits Corp. did \$50,000 worth of business, on pilot run and production orders, in 1951. The company thinks sales will increase from five to tenfold this year, covering telemetering devices, computers, decoding machines, tv tuners, classified ordnance items and hearing aids.

Plastics & Electronics has orders for printed circuits used in subminiature servo amplifiers and a subminiature transceiver, is making 150,000 voltage dividers each of which replaces 22 conventional resistors. In addition, the firm also expects to produce a four-tube subminiature broadcast receiver.

M. J. Sears is working on a method of turning out mechanized wiring on a continuous-strip basis, expects \$30,000 worth of business this year.

F. W. Sickles is developing major television components using printed-circuit techniques.

Stupakoff is getting ready for production of integrators, multipliers and amplifiers for both military and commercial use.

U. S. Gasket is moving out of the development stage.

► **Promising Volume**—No accurate estimate of the total volume of printed-circuit business is possible at this time for two major reasons: Many manufacturers of electronic equipment other than those spot-checked are using the technique to some extent in their own production rather than for resale or are 'not talking'; and an increasing percentage of the volume covers applications which are of necessity classified.

It is known only that business currently available is substantial, and growing more so every day.

Germanium - Threat or Promise to Electronics Industry?

Semiconductor devices will eventually replace many vacuum tubes—but try to buy a transistor today!

GERMANIUM, basis of transistors and new power rectifiers, is the enigma of the electronics industry. The material itself is a puzzler. Combining the properties of a conductor like copper and an insulator like glass, its importance in electronics resides in its ability to carry strong current under the control of a weak one.

This ability to amplify was once a virtual monopoly of the vacuum tube; by passing electrons through a vacuum or gas-filled space it is possible to exercise control over them. Now the same trick has been turned in a solid material. This not only eliminates the need for the vacuum, a costly if imponderable material, but makes possible the transistor, an amplifier having great mechanical strength, long (possibly indefinite) life, and high efficiency.

R. M. Burns of the Bell Laboratories, a pioneer in germanium electronics, predicted this month to the Society of the Chemical Industry that a new industry will grow from this material, rivalling the chemical industry in size. This is a big prediction, but one to be taken seriously since Bell Labs people are noted for conservatism in all things, let alone public utterances.

► **Transistors, Tomorrow**—But all this is in the future. Technicians have to be well connected to get samples today. ELECTRONICS called six manufacturers known to be working on commercial forms of the transistor, asking for order-placing information, got the following replies: Western Electric, none available, all going to military; General Electric, limited supply to equipment manufacturers only; Raytheon, did have model CK-703 available for \$18, now discontinued in favor of model CK-716 expected to be available next month; Sylvania, not on market, still in engineering stage; Westinghouse, not available commercially; RCA, not available. The new day may be dawning, but it's still pretty dark in the channels of trade.

► **Old Material**—Discovered in 1886, germanium found few uses (manufacturing special optical glass and treating anemia) until electronic technicians found it was a rectifier, that is, would change alternating current into pulsating direct current. But it had strong competitors in silicon and selenium in the rectifier field. Then Bardeen and Brattain of Bell Labs produced the first germanium transistor in 1948, and in 1950 the same group produced an improved form, the junction transistor. The latter unit is the 'hot item' that promises to revolutionize electronics.

One of the rare metals, a by-product of lead refining, germanium has been quoted for years at about \$200 per pound. The demand

COAST-TO-COAST COLOR SURGERY



Closed-circuit tv transmission in color of an operation taking place in Los Angeles, Calif., was viewed by a group of doctors in New York recently. The operating surgeon, shown at left center with glasses, operated to remove an arterial constriction in the heart of the patient

INDUSTRY REPORT →

PLASTICON "P" Capacitors—

utilize polystyrene
as the solid dielectric—es-
pecially suitable for these
applications:



- computers • calculators
- saw-tooth oscillators
- RC circuits
- electronic controls
- integrating circuits

Plasticon Type "P" Capacitors have gained wide acceptance for a variety of applications in addition to those listed above.

If you require the following characteristics, specify Plasticon "P" Capacitors:

Electrical characteristics at 25°C ambient temperature:

- high resistance 10^{11} ohms /mfd or 10^{11} ohms max.
- low power factor 0.05% or less
- low dielectric absorption 0.05%
- Q is practically constant from DC to 100 Kc

Other features:

- voltage ranges available 100, 400 and 1000V
- capacitance range 0.001 to 25 mfd
- capacitance tolerance 10% standard—also available 5%, 2% and 1%
- temperature range -60°C to $+90^{\circ}\text{C}$
- temperature coefficient approx. 150 PPM/ $^{\circ}\text{C}$ negative

Large values of capacitance are housed in CP 70 style containers. Soldered-in glass insulators assure hermetic sealing. Small values of capacitance are housed in our popular glassmike style containers.

OUR SPECIALTY is engineering capacitors to exacting requirements.

We invite your inquiries.

MANUFACTURERS
Glassmike Capacitors
Plasticon Capacitors
HiVolt Power Supplies
Pulse Forming Networks

All Phones: AMBassador 2-3727

Condenser **P**roducts Company



7517 North Clark Street • Chicago 26, Illinois

for it is still so small that the price of the raw product has not changed materially (present quotation \$180 per pound). The amount of germanium used even in the larger rectifier units is so small that raw material cost is almost negligible. Special refining methods, carried out in the manufacture of the transistor or rectifier, account for bulk of the material cost.

► **New Process**—Until recent months, transistors and germanium rectifiers were made from a slab cut into strips with a saw. Despite great caution in processing, it proved well nigh impossible to produce a uniform product. Consequently the early point-contact transistors were difficult to produce to the tolerances commonly met by vacuum tubes. Then the production of single-crystal germanium was tried, by withdrawing material slowly from a melt just on the point of freezing. Tests showed that this material was highly uniform. Moreover specific impurities, necessary to produce the rectifying and amplifying action, could be thereby introduced with great precision. Out of this technique came the junction transistor, and the germanium power rectifier.

At the moment the germanium power rectifier has the center of the commercial stage. As a rectifier in tv sets, and elsewhere where commercial alternating current must be changed to direct current, it promises to displace immediately the traditional vacuum tube rectifier and the less efficient selenium rectifier.

► **Today's Market**—Even in the heavy-current industrial field, the promise is nearly a reality. In theory an area the size of your little fingernail (one square centimeter) of single-crystal germanium will rectify 1,000 amperes, and 300 amperes has actually been carried in practical tests. This puts the germanium rectifier in the heavy-duty class, quite possibly a competitor to the thyatron and ignitron in such large scale applications as resistance welding control.

The long-term future is with the junction transistor, which will put

electronics into local telephone exchanges and other large-scale equipment where electron tubes have never been used because of limited life and costly consumption of power. It will radically

reduce the size of computers, and so simplify maintenance that such brain-savers may someday be commonplace in many business offices. But don't try to buy a transistor today.

Industry Activities

JETEC Holds First General Conference

Committees discuss tube standardization but individual engineers seem preoccupied with television

FIRST GENERAL CONFERENCE OF JETEC, the joint electron tube engineering council of the Radio-Television Manufacturers Association and the National Electrical Manufacturers Association, attracted 120 tycoons from the tube business to Absecon New Jersey's swank Seaview Country Club.

Topic officially discussed by 11 committees was standardization of tubes, work in progress ranging all the way from type designations to packaging. Unofficially, there was much talk about tubes for television.

► **Tube Trends**—Engineers buttonholed at the conference seemed preoccupied with the development of television-picture-tube glass faceplates having cylindrical cross sections. It appears that as picture-tube sizes increase conventional spherical-cross-section faceplates become annoyingly susceptible to reflections from room lights above, below or off at the sides of the screen. Cylindrical-cross-section faceplates reduce side reflections. Television picture tubes having smaller-diameter necks are evidently also under development. Easier vertical and horizontal deflection of the pencil-pointed electron beam forming the lines of the picture in large-screen sets is, we were told, the objective.

Receiving-tube engineers encountered at the JETEC meeting were in many cases thinking about

radio-frequency amplifier types they hoped would be suitable for use as the first tube in tuners designed for the ultra-high-frequency television band. Here the problem appears to be one of obtaining high

MEETINGS

MARCH 3-6: IRE National Convention, Waldorf-Astoria Hotel and Grand Palace, New York, N. Y.

MARCH 30: Sixth Annual NARTB Broadcast Engineering Conference, and 30th Annual Convention of NARTB, Stevens Hotel, Chicago, Ill.

APR. 7-9: Radio Component Show, Grosvenor House, Park Lane, London, W1, England.

MAY 5-7: Second Government-Industry Conference, sponsored by RTMA, NEMA, AIEE, at National Bureau of Standards, Washington, D. C.

MAY 5-16: British Industries Fair, Earls Court and Olympia, London, England, and Castle Bromwich, Birmingham, England.

MAY 13: RADIO CLUB of America, Room 502, Engineering Societies Building, New York, N. Y.

MAY 16-17: Fourth Southwest IRE Conference and Radio Engineering Show, Rice Hotel, Houston, Tex.

MAY 19-22: 1952 Electronics Parts Shows, Exhibition Hall, Stevens Hotel, Chicago, Ill.

JUNE 23-27: AIEE Summer General Meeting, Hotel Nicole, Minneapolis, Minn.

AUG. 12-15: 1952 APCO Conference, Hotel Whitcomb, San Francisco, Calif.

AUG. 27-29: Western Electronic Show and Conference, Municipal Auditorium, Long Beach, Calif.

SEPT. 8-12: National Instrument Conference and Exhibit, Cleveland, Ohio.

OCT. 20-22: Radio Fall Meeting, RTMA Engineering Department, Hotel Syracuse, Syracuse, N. Y.

18 BY-PASS ERIE CERAMICONS[®]



designed for MINIATURIZATION, RUGGEDIZATION

Erie Ceramicons fulfill all the requisites for efficient by-passing—compact design, low inductance, and conservative 500 volt D. C. rating. Erie Resistor offers the most complete line of ceramic by-pass units available. Each design has been thoroughly proven in domestic and military equipment.

Sixteen popular styles in ceramic ca-

pacitors are shown above. Feed-Thru's are supplied in values up to 2000 mmf, Stand-Off units up to 5000 mmf, Tubular and Disc units up to .01 mfd. Also shown above are two Silver Button Micacs representing the 370 series for values up to 1000 mmf and the 4700 series for values up to 6000 mmf. Write for samples to meet your specific requirements.

Electronics Division
ERIE RESISTOR CORP., ERIE, PA.
 LONDON, ENGLAND . . . TORONTO, CANADA

INDUSTRY REPORT—Continued

gain without introducing serious noise within the tube itself.

Power-tube engineers in several plants are concentrating on types that generate the final output power for 1 to 5-kilowatt uhf television transmitters.

TV Antenna Tested By Helicopter

HELICOPTERS have been used to determine the best location for television station towers with some success. Now there are indications that the versatile aircraft may prove equally useful in facilitating adjustment of tv transmitting antennas for best coverage after they are installed.

When WJZ-TV moved to New York's Empire State Building and at the same time increased power, the expected increase in signal strength was achieved in all but a few locations. One of these was nearby Long Island's north shore. Engineer John Preston boarded a helicopter and circled the antenna about 1½ miles out, carrying signal-strength-measuring equipment in his lap. A 'dip' in signal strength was noted in the direction of Long Island.

The antenna was adjusted and Preston went up again. This time the 'dip' was gone, and reports from the former weak-signal area later confirmed the improved coverage.

The helicopter test, incidentally, took ten minutes to run. Similar tests at ground level would have required weeks.

TV Labor Costs Drop

Man-hours down 27 percent per set in latest plant survey

COSTS GO DOWN as production goes up. Nowhere is this better illustrated than in a report covering the radio and television business just released by the Department of Labor.

The Department's Bureau of Labor Statistics questioned 22 plants late last year, now comes up with the fact that factory man-

hours required for the production of a typical television set declined 27 percent in 1949 . . . the latest full year for which figures are available . . . as against 1948, while man-hours required for the fabrication of an average radio set increased 2 percent.

► **Production Time**—Time required for the production of equipment in the period covered by the BLS survey ranged from 1½ man-hours on a table radio to 20½ man-hours on a combination tv-radio-phonograph.

Women comprised 50 percent of the work force in the radio-tv manufacturing business in September; they represented 27 percent of the work force in all manufacturing plants in that month.

Production workers engaged in the manufacture of radio and related products, in plants reporting, totalled 112,700 in 1949 as against 123,000 during the previous year.

► **Detailed Report**—Additional details regarding productivity are available in a report entitled "Trends in Man-Hours Expended Per Unit . . . Television and Radio Sets," available from the United States Department of Labor, Bureau of Labor Statistics, Washington, D. C., or its nearest regional office.

Fighter Planes Using New Lightweight Radar

A SMALL automatic radar unit that feeds information directly into a computing gunsight is now being installed in Air Force, Navy and Marine Corps fighter planes throughout the world.

This lightweight device eliminates guesswork on the part of the pilot. The radar is so accurate, it is reported, that inexperienced pilots, during aerial gunnery practice, have consistently downed towed targets with their first bursts.

Many types of fighter aircraft now incorporate the radar at the time of manufacture; others are scheduled to have it in the near future.

Now being produced on an assem-



Major General H. M. McClelland (left) inspects new gunsight radar

bly-line basis, the device is the most widely used radar in the world today, according to General Electric's Electronic Division.

Predict Distant A-Blasts

Trays On Roof Used In Radiation Count

TRAYS perched on the roof of 70 Columbus Avenue, (Atomic Energy Commission Building) New York City, or others in strategically located parts of the country, could tell the story of a Russian atomic explosion.

The AEC has set up radiation monitoring and warning systems, using 50 U. S. Weather Bureau stations throughout the country.

► **Labs Test Samples**—After collecting samples of particles in the air, the weather bureaus forward them to a laboratory located near them, in New York City, Rochester, N. Y.; Upton, N. Y.; Oak Ridge, Tennessee; Richland, Wash. and Los Angeles, California.

From dust and liquid samplings, the laboratories test for atomic radiation. Information is provided concerning location at which the sampling was taken, direction and speed of winds, and whether previous samples have come from that direction. The Commission says, in guarded language, that they are able to predict the location from which the collected

INDUSTRY REPORT →

**MITCHELL
RAND**

electrical insulation headquarters

features...

MIRAGLAS* *Cords*

- to provide maximum insulation
- greatest length of service
- most coverage per pound
- at lowest comparable cost

YES: here's an inorganic electrical insulation that is superior in every respect and yet costs less than any comparable cordage . . . the characteristics speak for themselves:

*Woven of fiberglas

		DIAMETER	YARDS PER LB.	TENSILE STRENGTH
<ul style="list-style-type: none"> • exceptional high tensile strength • resistance to moisture, oils, corrosive fumes, acids, alkalis 	TREATED	EC9-1-U .009"	3,620	15
		EC9-2-U .026"	702	80
		EC9-3-U .034"	418	135
		EC9-4-U .052"	209	220
		EC9-5-U .076"	103	330
		EC9-6-U .083"	87	420
		EC9-7-U .095"	65	510
		EC9-8-U .119"	43	725
		EC9-10-U .149"	28	940
	<ul style="list-style-type: none"> • will not rot, stretch or shrink • not affected by fungus 	UNTREATED	EC9-1-N .0105"	3,240
		EC9-2-N .032"	638	62
		EC9-3-N .039"	387	105
		EC9-4-N .062"	193	180
		EC9-5-N .084"	98	295
		EC9-6-N .094"	84	340
		EC9-7-N .110"	61	440
		EC9-8-N .128"	42	540
		EC9-10-N .165"	27	750

Manufacturers of electrical apparatus and appliances, repair and maintenance departments and rewind shops will find MIRAGLAS* CORDS ideal wherever a high quality binder twine or high strength tension member is required for: banding field and armature coils . . . wrapping string bands on small armatures . . . protecting front of commutator V-ring . . . reset strings . . . tying slot insulation . . . binding on V-ring extension . . . filling in winding coils . . . lashing ends of coils in large motors and generators—and when wax-treated for assembling and tying wire harnesses, etc.

- MIRAGLAS* CORDS are made by plying fine, strong, flexible fiberglas (filaments of glass). Available either treated or untreated. Treatments: oil, neoprene or wax.

For MIRAGLAS* CORDS as for all other ELECTRICAL INSULATIONS you can depend upon MITCHELL-RAND "Electrical Insulation Headquarters" since 1889.

Write to MITCHELL-RAND for free samples and descriptive data.



MITCHELL-RAND INSULATION CO., INC.

51 MURRAY STREET

COntlandt 7-9264

NEW YORK 7, N. Y.

A PARTIAL LIST OF M-R PRODUCTS: FIBERGLAS VARNISHED TUBING, TAPE AND CLOTH • INSULATING PAPERS AND TWINES • CABLE FILLING AND POTHEAD COMPOUNDS • FRICTION TAPE AND SPLICE • TRANSFORMER COMPOUNDS • FIBERGLAS SATURATED SLEEVING • ASBESTOS SLEEVING AND TAPE • VARNISHED CAMBRIC CLOTH AND TAPE • MICA PLATE, TAPE, PAPER, CLOTH, TUBING • FIBERGLAS BRAIDED SLEEVING • COTTON TAPES, WEBBINGS AND SLEEVINGS • IMPREGNATED VARNISH TUBING • INSULATING VARNISHES OF ALL TYPES • EXTRUDED PLASTIC TUBING

samples had started as well as an approximate time and date.

► **Results and Equipment**—AEC discussed one result of the latest Nevada test, with relation to New York City. They revealed that radiation reaching that city amounted to 1/300th of that used for an average chest x-ray, for a 24-hour period.

Electronic equipment used in the sampling tests, being conducted daily, is supplied the weather bureaus and laboratories by AEC. This insures that all stations are working with the same type of equipment. No new devices have been developed for these tests. Instead, modified versions of standard commercial equipment are being used.

Did AEC pick up dust samplings 'on the winds' from Russia last year? Corbin Allerdyce, the Commission's Public Information Officer in New York, ducked the answer by saying "at the present time, such types of question cannot be answered."

Radio Stations Test Plan To Fool Enemy Bombers

Use Air Force planes in 19-state 'air attack'

EASTERN AIR DEFENSE FORCE planes and 400 broadcasting stations conduct exercises this month in 19 states to test a method of staying on the air for direction of civil defense units during an enemy air attack.

A similar exercise, conducted in November, was worked out by the Federal Communications Commission and put into operation after preliminary tests in the western states. The current exercises will be the largest yet attempted.

► **Objective Of Plan**—The plan, discussed last year in *ELECTRONICS* (p 94, August 1951), is based on the 'synchronous sequential' method of transmission.

Synchronous sequential operation requires that each station of a cluster or group carrying the same program operate intermittently. As the first station leaves the air, another immediately comes

on. Ideally, the sequence in which the stations follow one another is varied.

The change in transmitters causes the radio compass of enemy planes to fluctuate erratically. If they attempt to 'home' on a particular station it will be off the air before they can successfully do so. Another station at some unknown place, in a different direction, will take its place.

► **Method Used In Test**—The 400 stations selected for the exercise are those which ordinarily go off the air between midnight and 1 A. M. They will be ordered to return to the air on a common fre-

quency at a specified time selected in advance of the test.

From 1:30 A. M. to 5:00 A. M., each of the stations will broadcast for one minute or less, after which the program will be passed on to the next station of the group.

► **Progress Reported**—The results will not be revealed, since they fall under military security classification. When queried concerning the previous test, Major General Frederic H. Smith, Jr., commanding general, Eastern Air Defense Force, and director of these quarterly exercises, commented, "We've come a long way but still have a long way to go."

Business Briefs

► **Next 5 Years** should see a vastly improved supply of copper, extremely important in the electronics field. So says Cornelius F. Kelley, Anaconda Copper Mining Company. He believes that the government's "propaganda" campaign urging the substitution of aluminum for copper is unnecessary if scheduled major projects are carried out.

Kelley predicts an increase of 40 percent in the copper supply by '56, with imports from friendly foreign sources plus stepped-up U. S. production. At that time, he says, there should be at least 125,000 tons produced per month, in comparison with present production levels of 90,000 tons.

One reason for the copper shortage, Kelley feels, is sub-normal scrap intake.

► **Bids Are Being Accepted** for the construction of a \$2 million storage and repair building for electronic equipment at the Naval Station, San Diego, California.

The 11th Naval District Public Works Office reports that construction will be started this year under supervision of Navy civil engineers.

► **Extra Compensation** to electronic engineers for longer-than-normal

hours has been approved by the Salary Stabilization Board. The engineers will be allowed to receive extra pay comparable with that paid to production workers for extra work.

► **No Public TV In Japan** likely in 1952, State Department representative in Tokyo says, quashing a rumor prevalent in trade circles that technical, regulatory and financial obstacles prevent commercial licensing of tv at this time. Four tv license applications pending . . . one experimental station operating.

► **Six Month Guarantee** on cathode-ray picture tubes has been set up for receiver manufacturers by DuMont Laboratories. Guarantee starts from date of actual installation of receiver in consumer's home. Plan, which starts immediately, may set tube guarantee pattern for the industry.

► **2,000 Women Hold** amateur radio operators' licenses in the U. S., according to *QST*, official organ of the American Radio Relay League, which has instituted a column to serve feminine interests. The column reports stations contacted and distant countries worked by the YL's and XYL's.

**104 Series****1000 V (RMS)**Flange Diameter .200
Mounting hole $\frac{1}{8}$ "
Electrode treatments
SW and L**105 Series****1500 V (RMS)**Flange diameter .250
Mounting hole $\frac{1}{8}$ "
Electrode treatments
SW and L**106 FP****1500 V (RMS)**Flange diameter $\frac{19}{64}$ "
Mounting hole $\frac{1}{8}$ "
Electrode treatment
FP only**107 Series****2000 V (RMS)**Flange diameter $\frac{5}{8}$ "
Mounting hole $\frac{15}{64}$ "
Electrode treatments
TH, HT, FP, HTL,
and FPSW**108 Series****2000 V (RMS)**Flange diameter $\frac{3}{8}$ "
Mounting hole $\frac{3}{32}$ "
Electrode treatments
TH, HT, FP, HTL,
and FPSW**109 Series****2500 V (RMS)**Flange diameter $\frac{1}{2}$ "
Mounting hole $\frac{5}{16}$ "
Electrode treatments
TH, HT, FP, HTL,
and FPSW**110 R Series****3000 V (RMS)**Flange diameter $\frac{7}{8}$ "
For exterior mounting
Electrode treatments
HTL, HT, FP, FPSW,
and FPNH**112 Series****3000 V (RMS)**Flange diameter $\frac{1}{2}$ "
Mounting hole $\frac{3}{8}$ "
Electrode treatments
HTL, HT, FP, FPSW,
and FPNH**112 R Series****3000 V (RMS)**Flange diameter $\frac{1}{2}$ "
For exterior mounting
Electrode treatments
HTL, HT, FP, FPSW,
FPNH and FP Threaded**105 TB-FP****1500 V (RMS)**Flange $\frac{3}{8}$ " hex.
Mounting hole $\frac{1}{4}$ "
28 threaded
Electrode treatment
FP only

Meet the FUSITE FAMILY of SINGLE TERMINALS

Glass to Steel for a True Fused Hermetic Seal

Protect Sensitive Electrical Components from

- DIRT
- FUMES
- MOISTURE
- CHANGING PRESSURES

GENERAL SPECIFICATIONS

materials -- C.R. steel disc and steel electrodes. Interfused with glass.

finish -- fused electro tin plate.

voltage test -- see individual terminal.

pressure test -- 12 pounds gauge.

insulation test -- 10,000 megohms after salt water immersion.

sudden thermal shock test -- dry ice to boiling water.

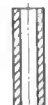
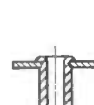
Key to Electrode Treatment Available on These Terminals**TH**
TURRET
HEAD**FP**
FLATTENED
AND PIERCED**HT**
HOLLOW
TUBE**L**
LOOPED**HTL**
HOLLOW
TUBE LUG**NH**
NAIL
HEAD**SW**
STRAIGHT
WIRE*Write for Catalog*OF COMPLETE LINE AND
ENGINEERING DETAILS -- DEPT. B**THE FUSITE CORPORATION**

6028 FERNVIEW AVENUE - CINCINNATI 13, OHIO

NO NEED FOR HAVING TECHNICAL CERAMIC TROUBLE!



DEFENSE or INDUSTRIAL
STANDARD or SPECIAL

Lavite CERAMICS

ARE AVAILABLE IN AN UNLIMITED
RANGE OF CHARACTERISTICS

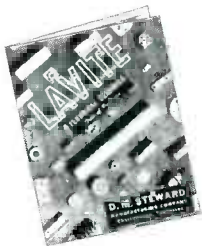

Send for tables of characteristics of standard "LAVITE" Ceramics. For special needs send your specifications to our engineers for recommendations.

Remember—

There are non-critical Ferrites for non-critical defense uses.

Although scarcity of materials are causing trouble, even in ceramics — you can be sure that your needs will be completely satisfied by Steward's increased capacity to produce "LAVITE" Ceramics — (LAVITE Steatites, LAVITE Ferrites, LAVITE Titanates), if those needs can be at all answered.

Standard Ceramic products, most of which are in production every day, are promptly available in large quantities.

Special requirements receive immediate and experienced attention by Steward engineers assuring scientifically developed solutions to your most exacting Technical Ceramic problems.

D. M. STEWARD MANUFACTURING CO.

3604 Jerome Ave.

Chattanooga, Tennessee

Sales Offices in Principal Cities

CONDENSERS • PLUGS • INST
 RESISTORS • PANELS •
 TRANSFORMERS • RELAY
 METERS • RG CABLE & W
 TUBES • RECTIFIERS • INSTR
 UG and AN CONN
 ORS

EVERYTHING
in **ELECTRONICS**
at your fingertips —
 from **THE NATION'S**
GREATEST INDUSTRIAL
ELECTRONIC
DISTRIBUTOR!



FREE!
1100 PAGE
CATALOG!

JAN EQUIPMENT

Purchasing Agents! Engineers!
 Here's the answer to your procurement problems! Send today for our gigantic new 1952 Buying Guide, describing and illustrating over 75,000 standard brand radio-electronic items—most of which we carry in stock! Write on your company letterhead, stating your official position or title. Address Dept. EF.

MILO — INDUSTRIAL SPECIALISTS —
GEARED 100% TO SERVING INDUSTRIAL ACCOUNTS!
 Just one dependable source for all your electronic needs!
 MILO stocks everything used in all electronic applications!

PHONE — WRITE — WIRE or TELETYPE FOR FAST SERVICE!

MILO RADIO

& ELECTRONICS CORPORATION
200 GREENWICH STREET, NEW YORK 7, NEW YORK

Phone BEekman 3-2980 • Teletype NY1-1839 • Wire MILO-WUX-N.Y. • Cable MILOLECTRO-N.Y.



PART OF OUR INDUSTRIAL SALES STAFF.



VIEW OF MAIN OFFICES



PARTIAL VIEW OF OUR IMMENSE STOCK ROOMS



COMPLETE STOCKS ALWAYS ON HAND

3 New Resistors

-55°C to +150°C

Complete aridity to saturation . . . An unprecedented temperature and humidity range

FOR MILITARY APPLICATIONS

Highly recommended for use in jet and other planes, guided missiles, tanks, ships and submarines, portable or mobile equipment and all other military communications. Manufactured from specially developed materials, these absolutely unique variable resistors are now available in a complete range of sizes. (See chart at bottom of page.)

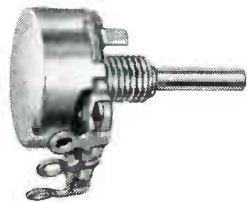

Type 65



Type 90



Type 95

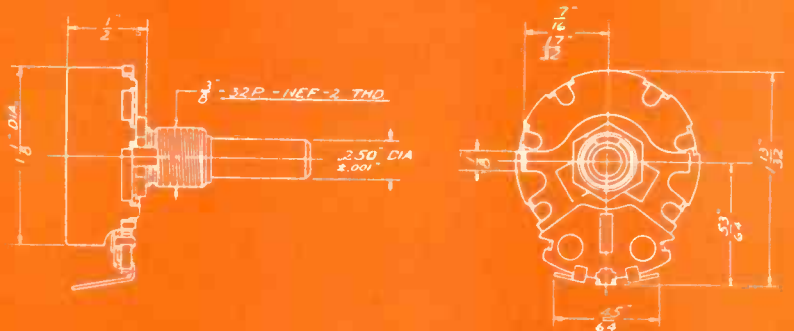
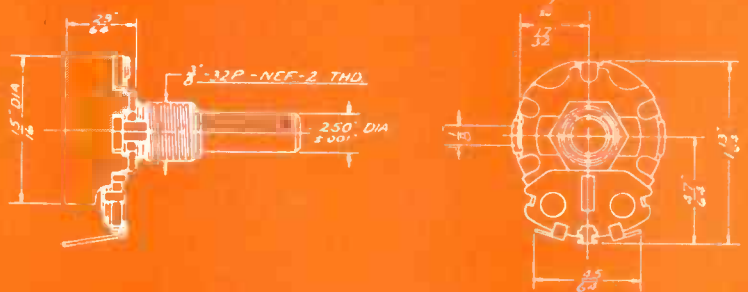
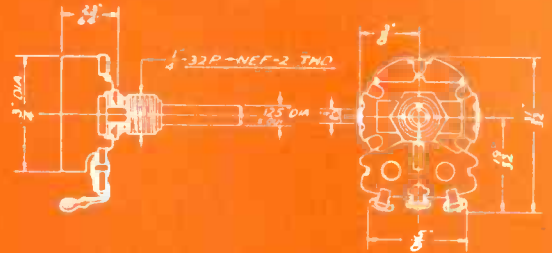

+150°C to -55°C

DIAMETER	TYPE 95 1 1/8"	TYPE 90 1 5/16"	TYPE 65 (miniaturized) 3/4"
Wattage and Voltage Rating	2 watts @ 70°C with 500 V max. across end terminals	1 watt @ 70°C with 500 V max. across end terminals	1/2 watt @ 70°C with 350 V max. across end terminals

Specialists in Precision Mass Production of Variable Resistors

Meets Military Specifications



JAN-R-94, Type RV-3A
CTS Type 35, 1 1/8" Diameter
Composition



JAN-R-94, Type RV-2B
CTS Type GC 45 with Switch
Composition



JAN-R-94, Type RV-3B
CTS Type GC 35 with Switch
Composition



JAN-R-94, Type RV-2A
CTS Type 45, 1 5/16" Diameter
Composition

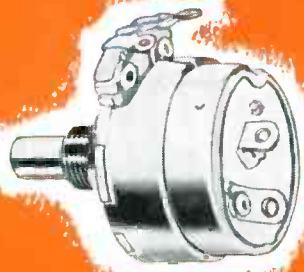

JAN Type RV-4B
CTS Type FGC 95 with Switch
Composition

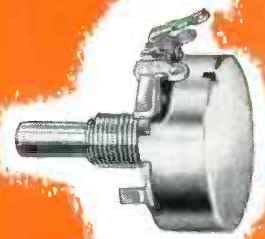

JAN Type RV-4A
CTS Type 95, 1 1/8" Diameter
Composition

MEETS ALL JAN-R-19 SPECIFICATIONS



JAN Type RA 20A
2 Watt CTS Type 252



JAN Type RA 20B
2 Watt CTS Type GC-252



JAN Type RA 25A or 30A
3 or 4 Watt CTS Type 25



JAN Type RA 25B or 30B
3 or 4 Watt CTS Type GC 25

EXCEPTIONALLY GOOD DELIVERY CYCLE
on military orders due to enormous mass
production facilities . . . Please give complete
details on your requirements when writing
or phoning for further information.



CHICAGO TELEPHONE SUPPLY
Corporation

FOUNDED 1896

ELKHART • INDIANA

REPRESENTATIVES

Henry E. Sanders
401 North Broad Street
Philadelphia 8, Pennsylvania
Phone: Walnut 2-5369

W. S. Harmon Company
1638 So. La Cienega Blvd.
Los Angeles 35, California
Phone: Bradshaw 2-3321

IN CANADA
C. C. Meredith & Co.
Streetsville, Ontario

SOUTH AMERICA

Jose Luis Pontel
Buenos Aires, Argentina
Montevideo, Uruguay
Rio de Janeiro, Brazil
Sao Paulo, Brazil

OTHER EXPORT

Sylvan Ginsbury
8 West 40th Street
New York 18, N. Y.

RELATIVE POWER ONE WAY (db)

WORKSHOP RADAR ANTENNA RESEARCH

ANGLE

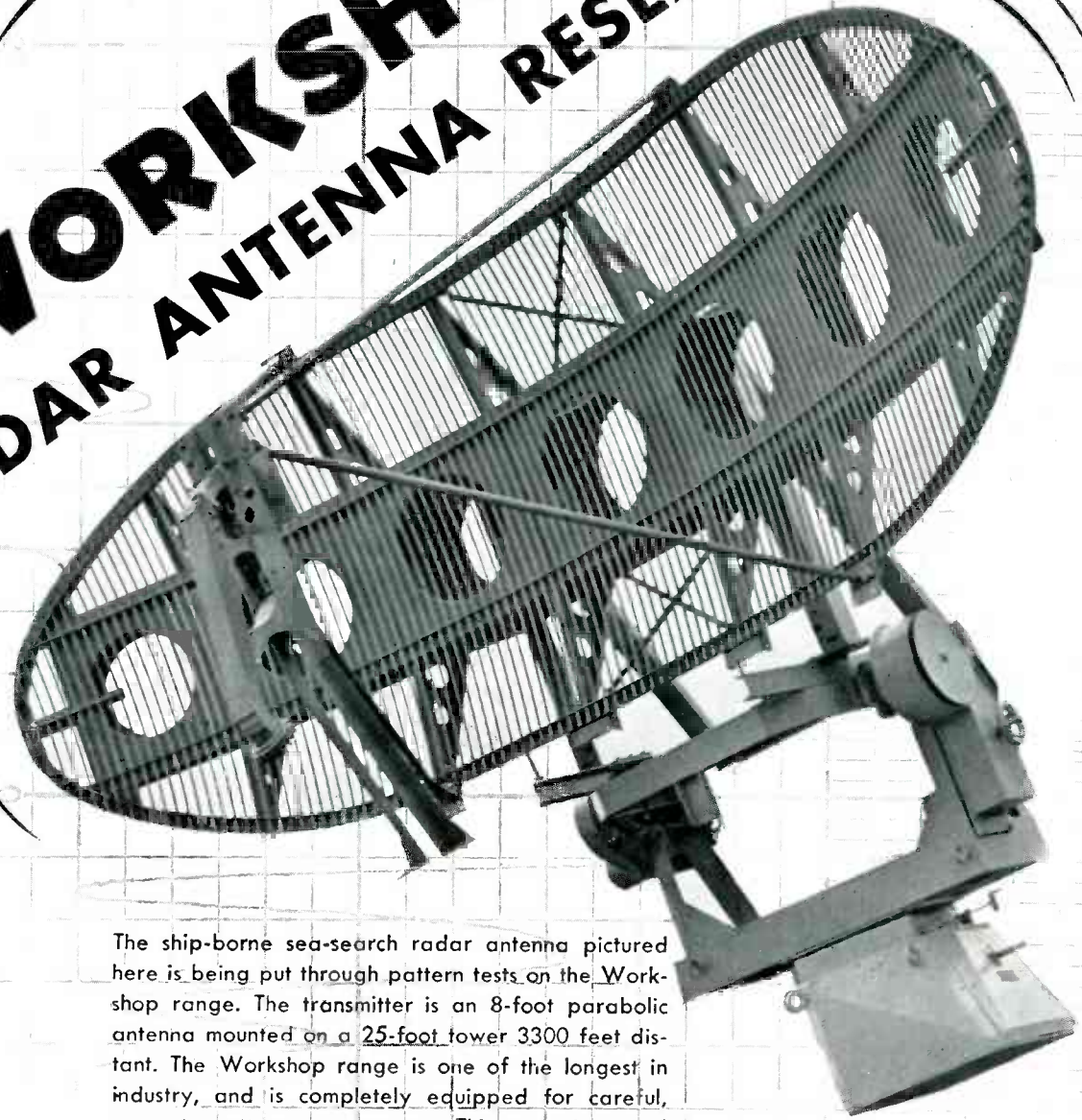

The ship-borne sea-search radar antenna pictured here is being put through pattern tests on the Workshop range. The transmitter is an 8-foot parabolic antenna mounted on a 25-foot tower 3300 feet distant. The Workshop range is one of the longest in industry, and is completely equipped for careful, accurate pattern measurements. This range is typical of Workshop's outstanding facilities for research, development and production. These facilities are constantly at work for government and industry in the solution of difficult antenna problems.



The **WORKSHOP ASSOCIATES**

DIVISION OF THE GABRIEL COMPANY

Specialists in High-Frequency Antennas

135 Crescent Road, Needham Heights 94, Massachusetts

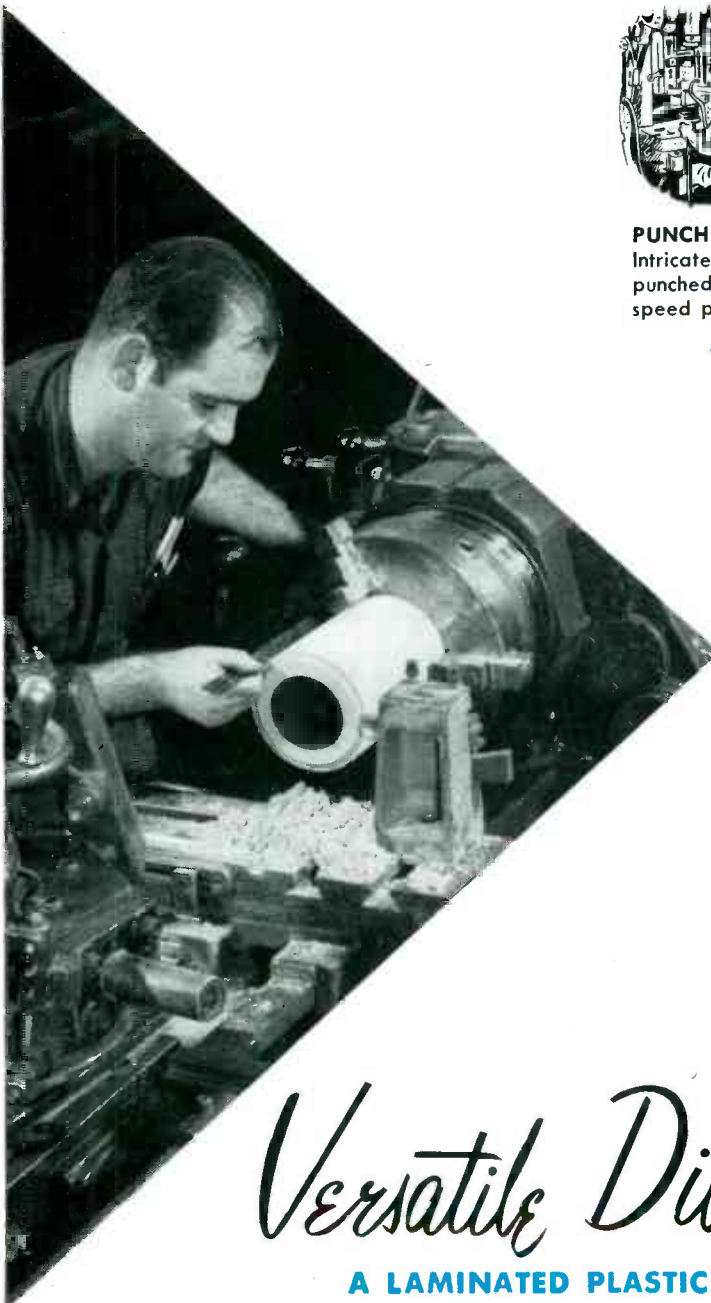

PUNCH IT—
Intricate parts are punched on high speed presses.

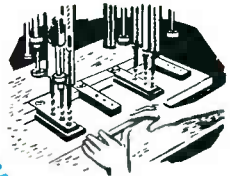

DRILL IT—
Dilecto drills fast and clean.



SAW IT—
Dilecto can be fed rapidly, without forcing.



MILL IT—
Dilecto takes higher speeds and feeds.

Versatile Dilecto...

A LAMINATED PLASTIC THAT'S EASY TO MACHINE!

Dilecto sheets, rods, and tubes have been machined into thousands of parts—some simple and some amazingly intricate. Engineers everywhere are specifying Dilecto for applications requiring a strong, low cost, high quality plastic. Here's why:

Non-metallic Dilecto remains unaffected by water, steam, oil, most chemicals, dies, solvents, acids. Silicone—glass fibre Dilecto withstands 200°C. (392°F.) continuous operating temperature. Mechanically strong, electrically superior, Dilecto is light weight and *easy to fabricate*.

Your C-D-F sales engineer can tell you about applications, grades, deliveries. Give him a call today (sales offices in principal cities)—he's a good man to know!

Write C-D-F, Newark, Del., for new . . . free plastics machining notebook.



Continental-Diamond Fibre Company

NEWARK 2, DELAWARE

SPARE PARTS BOXES



No. 1025-6
18" x 9" x 9"



No. 1025-1
12" x 6" x 6"

24 STOCK SIZES

Made to Army-Navy specifications — Jan-8-233 amendment — 2 —
Mar. 10, 1950, Army No. 65-15. Navy No. 4239C, Army green,
Navy grey. Immediate Delivery.

Number	Length	Width	Height	Number	Length	Width	Height
1025-1	12	6	6	1025-13	18	18	12
1025-2	12	9	6	1025-14	30	15	12
1025-3	12	12	6	1025-15	24	15	12
1025-4	12	9	9	1025-16	24	15	15
1025-5	18	9	6	1025-17	24	18	12
1025-6	18	9	9	1025-18	24	18	15
1025-7	18	12	9	1025-19	24	18	18
1025-8	18	6	6	1025-20	24	12	9
1025-9	18	15	9	1025-21	42	9	9
1025-10	18	12	6	1025-22	36	12	9
1025-11	18	15	12	1025-23	30	15	9
1025-12	18	12	12	1025-24	42	12	9

No. 1025-14
30" x 15" x 12"
(Partitions not included)



manufacturers of
the famous
Cole steel
office equipment

COLE STEEL EQUIPMENT CO.

285 MADISON AVE., NEW YORK 17, N. Y.

FACTORY: YORK, PA.

OERSTED

...**FIRST** to establish the relationship between electricity and magnetism

*Hans Christian
Oersted*

1777-1851

This great Danish physicist accidentally discovered that a compass needle is deflected when brought near a wire carrying a current. In further experiments, he established that such currents produce a circular magnetic field around the wire. The oersted, C. G. S. unit of magnetizing force, is named for him.

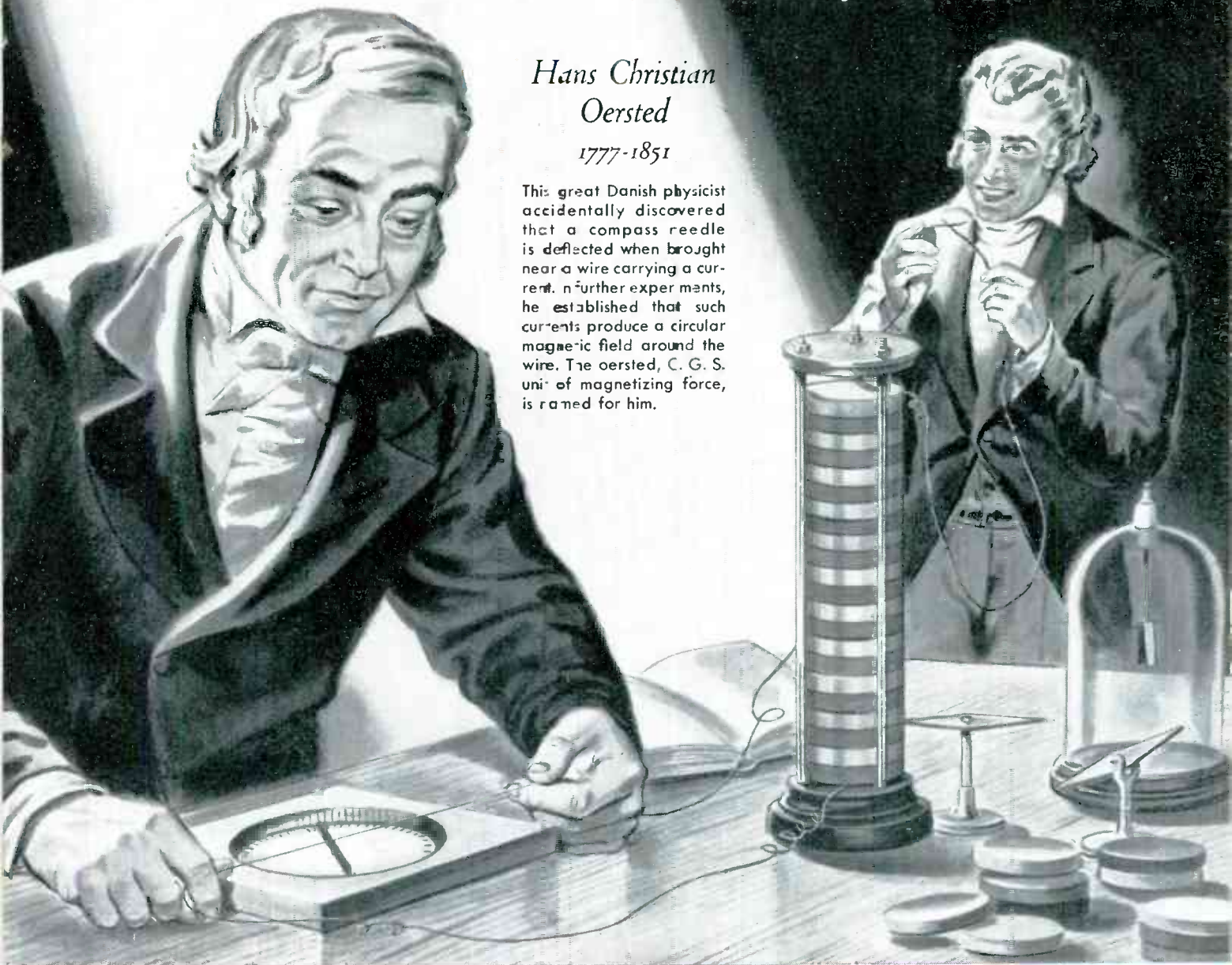

From an original drawing made for OHMITE.

OHMITE

...**FIRST** in Rheostats

...today

Be Right with

OHMITE

RHEOSTATS

RESISTORS

TAP SWITCHES



More manufacturers have standardized on Ohmite rheostats for their products . . . more companies are buying Ohmite rheostats for their own use . . . than any other make of rheostat on the market, today. The primary reason for this industry-wide preference for Ohmite rheostats is their proven dependability . . . their ability to give *extra* years of unfailing, trouble-free service.

What Special Feature do you need in a RHEOSTAT?

OHMITE CAN SUPPLY IT!

In addition to standard rheostats, Ohmite offers rheostats with a wide variety of *special features*. All have the distinctive Ohmite design features: smoothly gliding metal-graphite brush; all-ceramic construction; insulated shaft and mounting; windings permanently locked in place by vitreous enamel.



BUSHINGS FOR SPECIAL PANEL THICKNESS



Extra-long bushings and shafts allow mounting on panels up to 2 inches in thickness. Seven bushing lengths are available, from 1/4 to 2 1/8 inches.

360° WINDING

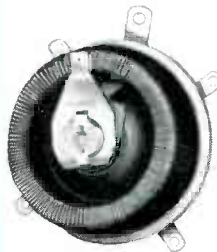

Two small models available with continuous circular core and endless winding. Unlimited rotation of shaft and contact arm. Taps supplied at any desired angle on windings.

DEAD LUG OFF POSITION



Opens the circuit at the high or low resistance position as the contact passes on to the lug, which is disconnected from the winding. Recommended for light duty.

SCREW DRIVER SLOT SHAFT



Where infrequent adjustments are needed, shaft ends can be slotted for operation with a screwdriver. Tampering with the shaft setting is thus minimized.

SEALED, ENCLOSED CAGES



Compact, corrosion-resisting metal enclosure, permanently sealed by a double seam, protects the unit completely. Available with rheostat Models H and J.

SNAP-ACTION OFF POSITION



Opens the rheostat circuit at the high or low resistance position. The circuit is opened as the brush snaps into an insulated notch next to the lug, providing indexing.

TANDEM ASSEMBLIES



Ohmite rheostats can be mounted two or more in tandem, for simultaneous operation of several circuits. Universal joints provide smooth, positive mechanical action.

TOGGLE SWITCH



Toggle switch is operated with a positive snap by the movement of the contact arm. Opens the rheostat circuit or switches an independent circuit. Available for all models.

LESS THAN STANDARD ROTATION

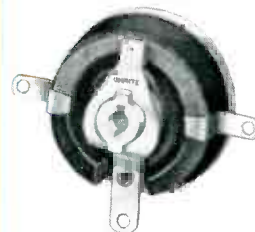

Rheostats can be supplied with winding space and angle of rotation less than standard. Rheostats can also be supplied with fixed or adjustable stops.

OHMITE MANUFACTURING COMPANY

4816 Flournoy Street, Chicago 44, Illinois



WRITE on Company Letterhead for Catalog and Engineering Manual No. 40.

Be Right with

OHMITE®

RHEOSTATS • RESISTORS • TAP SWITCHES

NOW! AIR-COOLED FOR TV



Eimac 4X20000A

- ★ 20 Kw Peak Sync. Output
- ★ 5 Mc. Bandwidth
- ★ 216 Mc. Operation
- ★ Ceramic Envelope

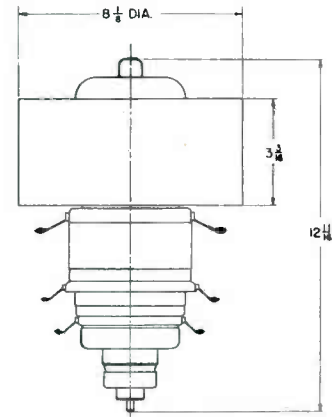

Here's the companion tube to Eimac's sensational 4W20000A . . . the 4X20000A, the new powerful and practical air-cooled transmitting tetrode developed for TV on VHF. The 4X20000A incorporates all the special characteristics of the water-cooled tube including a ceramic envelope that gives greater mechanical strength and higher resistance to thermal shock. Integral contact fingers assure proper terminal contact and simplify circuit construction.

This tube's potentials are not limited to television. Write for available literature.

● **SEE THE 4X20000A at the
March IRE Show, our regular booth No. 36**



TYPICAL OPERATION

Class-B Linear Amplifier — Television Visual Service
(Per tube, 5-Mc. Bandwidth, 216 Mc.)
Peak Synchronizing Level

Load Impedance	400 Ohms
D-C Plate Voltage	5500 Volts
D-C Screen Voltage	1200 Volts
D-C Control Grid Voltage	-240 Volts
D-C Plate Current	7.1 Amp.
D-C Screen Current (approx.)	500 Ma.
Peak R-F Grid Input Voltage	430 Volts
Plate Power Input	39.1 Kw.
Plate Dissipation	16.5 Kw.
Useful Plate Power Output	20.1 Kw.

EITEL-McCULLOUGH, INC.

SAN BRUNO, CALIFORNIA

Export Agents: Frazar & Hansen, 301 Clay St., San Francisco, California

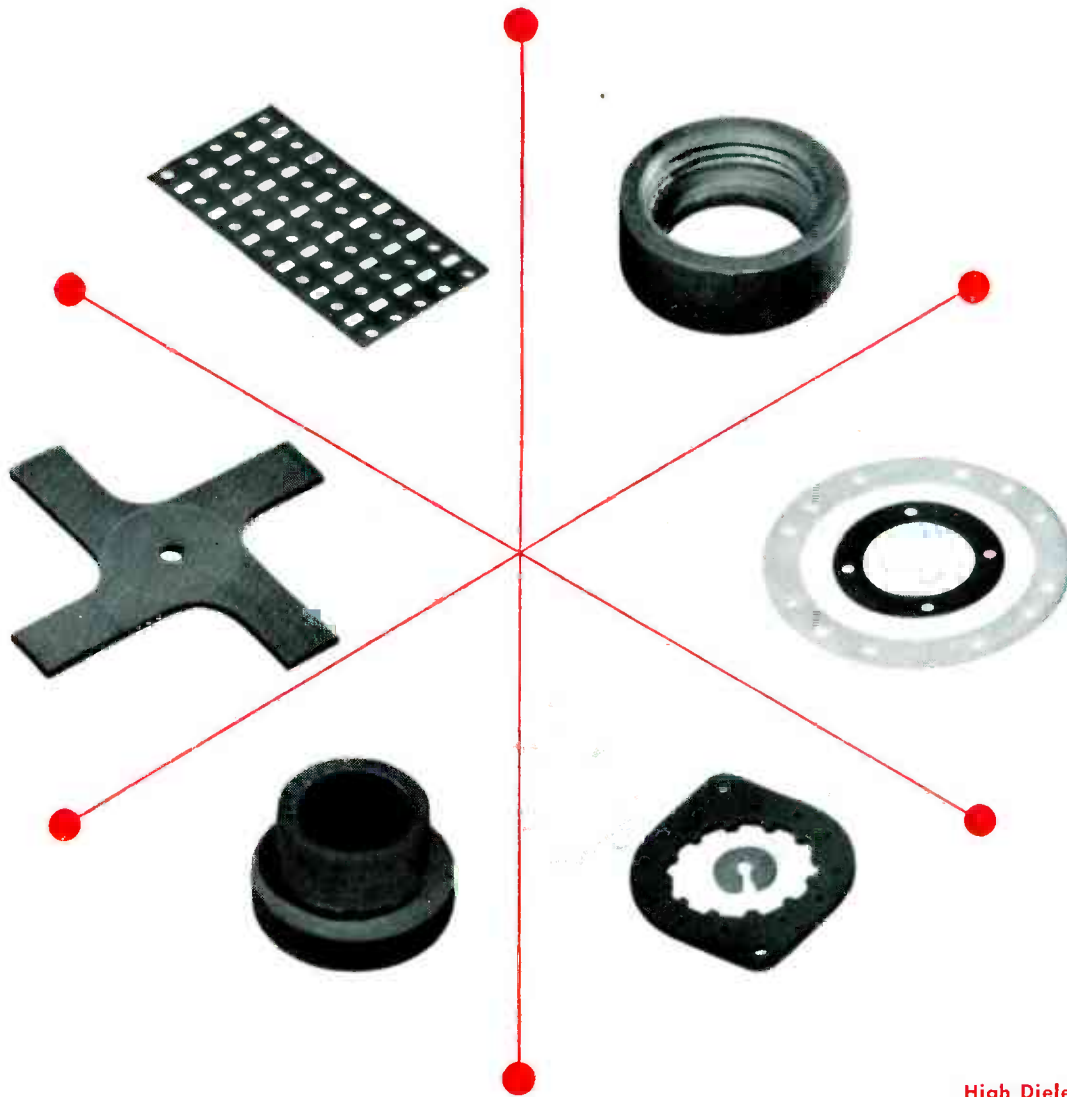

new uses for an old friend... *Lamicoid*[®]

- High Dielectric Strength
- Low Power Factor
- Heat Resistance
- Low Moisture Absorption
- High Impact Resistance
- Dimensional Stability
- Light Weight
- Tensile Strength
- Abrasion Resistance

You probably know LAMICOID (Laminated Plastic) as an old friend for such uses as tube socket supports, coil forms, dials, panels, antenna parts and many other applications.

The same qualities that make it adaptable to these uses may also provide practical answers to your material shortage problems . . . and perhaps even bring you savings or improvements!

LAMICOID is made with fillers such as glass, nylon,

paper, fabric, etc. and a variety of resins. This wide range of materials makes it almost certain that LAMICOID can give you the essential mechanical, structural, or insulating characteristics your product requires.

LAMICOID is supplied as standard sheets, rods and tubes, or fabricated into parts to your specification. Why not let us put our 58 years of experience to work on your electrical insulation problems. Send your blueprints and specifications to us today for prompt quotation.



MICA *Insulator* **COMPANY**

Schenectady 1, New York

Offices in Principal Cities

LAMICOID (Laminated Plastic) • MICANITE (Built-up Mica) • EMPIRE (Varnished Fabrics and Paper) • FABRICATED MICA

BRING THROUGH EQUIPMENT FAST!

**FROM STANDARD STOCK COMPONENTS
YOU CAN SIMPLIFY DESIGN —
SPEED PRODUCTION — AND CUT
SERVICE COSTS**

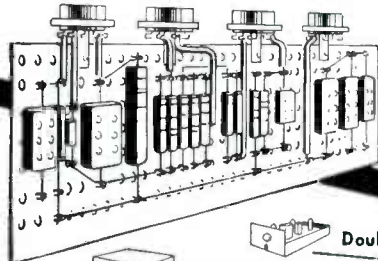
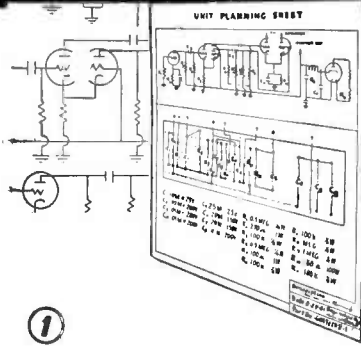

① ORGANIZE CIRCUITS QUICKLY

Schematics of most electronic equipment can be broken down into circuit blocks of logically associated functions. These functional circuit blocks can be mounted readily either in the Alden "20" plug-in packages or Basic Chassis unit. Tube sockets and associated components quickly lay out on full scale Unit Planning Sheets for mounting on terminal cards. These special pre-punched, multi-hole terminal cards have wide flexibility to take an infinite variety of circuit variations. Both sides of card can be used to obtain maximum component density area. Using the Unit Planning Sheets, functional circuit units are all planned in one step.

IT'S AS SIMPLE AS THIS!

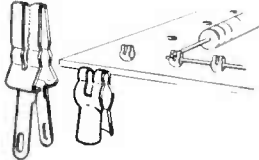

Miniature Terminals — 650 Series

Terminal cards have been designed to accommodate tremendous number of circuit variations — to make neat tube and component sub-assemblies with a minimum of wiring and simplified assembly techniques. Special Alden Miniature Terminals are new and radical punch press configuration — ratchet slot holds various size component leads for soldering — no twisting of leads with pliers. Figure "eight" shape accommodates cross wiring and buss leads. Terminals are punch press parts — so take a minimum of solder, reduce solder time, eliminate danger of cold solder joints.

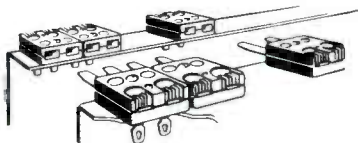

Back Connectors — 462MIN Series

Alden Terminal Card System means minimum of inter-cabling — but even this cabling can be laid out easily and proceed as simple sub-assembly. Open sided chassis construction makes cable easy to wire to front panel, terminal cards and back connectors. The Alden Back Connectors are units that can be discretely positioned on the back of the chassis — isolating lines with incompatible voltages, currents, or frequencies. This design insures accessible solder terminals for soldering — avoids rat nests of congested conventional back connector wiring. Color coded, the Alden back connectors provide beautiful operational or service check points for all leads to and from chassis.

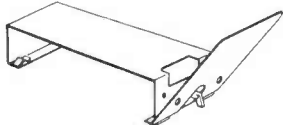

Hinged Front Panel Design

Hinged front panel design of chassis allows rheostats, indicator lights, jacks, etc. to be mounted on panel as another easy-to-work sub-assembly. This panel attaches easily to chassis — is wired — swung up and fastened with Alden Target Screws.

② GET EASY SUB-DIVISION OF LABOR

Solder terminals and sockets quickly rivet to Alden terminal card according to layout on Unit Planning Sheet. Components snap into the special Alden Miniature Terminals which hold them for soldering — (No twisting or wrapping of leads necessary) — With all tube sockets and their associated components mounted on one card — the wiring and soldering of circuits is an open, easy-to-work sub-assembly operation.



Target Screws

These screws have concave head with arced notch so power screw driver locates head quickly, no danger of it slipping out and marring panel surface — yet same screw can be unfastened with coin in order to hinge forward the front panel for servicing and check in the field.

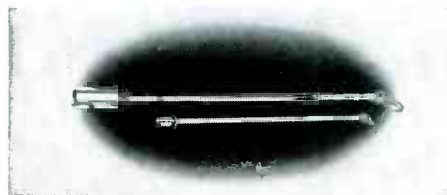

"Serve-A-Unit Lock"

Assembled — the Basic Chassis simplifies operation of equipment — Slashes service and maintenance time. Smooth, positive insertion and removal of the chassis is provided by the Alden "Serve-A-Unit Lock." A simple twist of the handle and the chassis backs off with finger tip ease. It also pilots the chassis back into place — securely locking it for operation with the same facility.

TO GET STARTED QUICKLY!

Wire for sample Basic Chassis at \$40. — and Alden "20" Plug-in Packages at \$10. — write Dept. B for booklet "Basic Chassis and Components for Plug-in Unit Construction."

SEE US AT BOOTH N3 THE IRE SHOW, GRAND CENTRAL PALACE, NEW YORK CITY



③ CUT SERVICE AND MAINTENANCE COSTS IN FINAL EQUIPMENT

In field, shop, or office your equipment maintenance is reduced to 30 second changeovers. Basic replacement elements are small enough in weight and size to be shipped by parcel post for repair.

FOR SMALLER UNITS ALDEN "20" PLUG-IN PACKAGES

Here is a plug-in package unit using the above method of converting schematic into finished assembly quickly. Simply mount the completed terminal card sub-assembly on the Alden "20" Non-Interchangeable base, dip solder the leads — add cover or housing and handle and it's completed — In operation, visual or instrument checks are easily made — if trouble occurs doubtful units are quickly isolated — these units easily unplug and a comprehensive inspection made. Spare units can be plugged in so equipment doesn't have to be inoperable while repairs are in process.

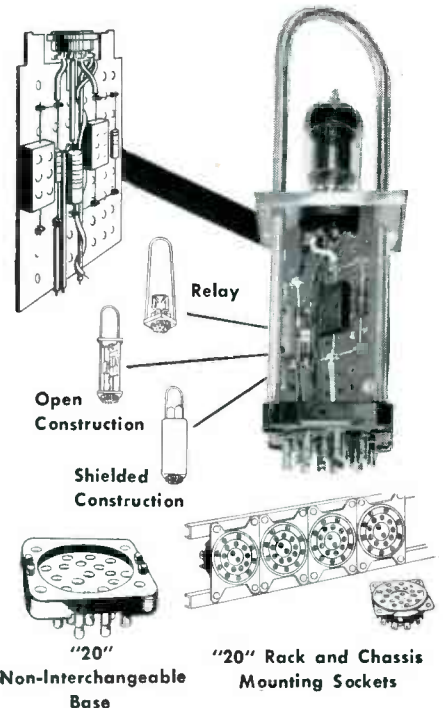

Instruments

BROWN ELECTROMETER

For measuring and recording currents as low as 10^{-15} amperes. High accuracy provided through use of a null balance servo system and a-c amplifiers which eliminate drift common to d-c amplifiers. Used to measure and record minute currents in ionization chambers and wherever currents as low as a billionth of a microampere are encountered. The only such system that incorporates a recorder as an integral part of the circuit.

Electrical Characteristics

Full Scale Current Ranges Available: 10^{-15} amperes with 10^{11} ohm resistor, and selector switch adjustment for full scale or 10^{-12} or 10^{-11} amperes. Using other resistors, full scale current changes up to 10^{-7} amperes can be supplied with selector switch adjustment up to 10^{-5} amperes.

Input Resistor: 10^{11} ohms for most sensitive current measurement. (Also supplied in values down to 10^3 ohms.)

System Accuracy: Approximately 1 per cent of scale.

Zero Drift: Should not exceed 0.3 millivolt per day.

System Noise: Approximately 5 microvolts.

Instrument Speed of Response: Available for either 24, 12, or $4\frac{1}{2}$ seconds full scale.

Maximum Speed of Response Using $4\frac{1}{2}$ Second Instrument Speed: 5 seconds for 90 per cent of change, with preamplifier located at source.

Power Supply: 115 volts, 60 cycles. Also dry cell supplied in instrument.

Power Requirements: 65 watts.

For further information, send for Data Sheet No. 10.0-4.

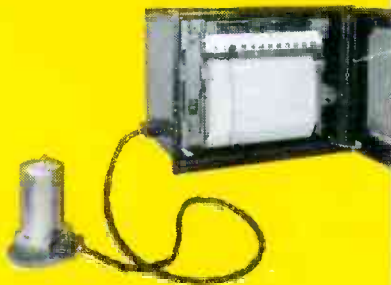

FUNCTION PLOTTER

Can be advantageously employed wherever there is occasion to depict graphically one variable as a function of another. It imparts speed, accuracy and efficiency to the plotting of curves.



Special Instruments

BROWN EXTENDED RANGE PRECISION INDICATOR

Ideal for facilitating the measurement of a variable where it changes throughout a wide range, and where precise evaluation and good readability are vital factors. Incorporating extended scale with automatic range changing operation, the instrument can be supplied with from two to five ranges, calibrated in emf or the specific quantity under measurement (i.e., pounds or tons of force or thrust, millivoltage, temperature, etc.).

For further information, send for Data Sheet No. 10.0-3.

DUPLEX TWO PEN RECORDER

Provides simultaneous measurements of practically any combination of two independent variables (voltage, current, temperature, pressure, etc.) on a single chart thereby facilitating comparisons of the two variables. Has two separate measuring systems with associated pens. Pens are entirely independent, and traverse the full eleven inches of chart width without interfering with each other. Both measuring circuits are standardized simultaneously by means of a push button. Actuation and range of the circuits may be the same or totally different.

For further information, send for Data Sheet No. 10.0-6.

NARROW SPAN RECORDERS

New narrow span potentiometer circuit makes possible precise measurement of spans as low as 100 microvolts. Instruments embodying this new circuit (recorders and precision indicators) are available as self-contained units requiring no pre-amplifier unit. The instruments find ready use wherever accurate measurement of d-c potentials of the order of microvolts is required. Potentials as low as one microvolt can be precisely determined. Can be calibrated in terms of temperature, emf, etc.

For further information, send for Data Sheet No. 10.0-8.

NEW ElectroniK HIGH SPEED RECORDER

Ideal for accurately measuring and recording rapidly changing variables often found in research, engineering analyses and other technical investigations. Develops a pen speed sufficiently high to traverse its 11-inch graduated chart in one second. Full scale signals which vary as rapidly as 20 cycles per minute can be accurately recorded. Signals with a peak-to-peak amplitude of 10% of scale can be reproduced at variations up to 180 cycles per minute.

For further information, send for Data Sheet No. 10.0-7.

Components

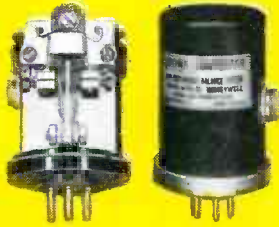

BROWN CONVERTERS

May be used with any system requiring the conversion of low power d-c signals, of the order of 100 microvolts, to 60 or 400 cycle alternating voltages. Output is unaffected by atmospheric pressure changes. Special material in reed assembly reduces pick-up of strays and transients to negligible proportion. Particularly useful in applications requiring error voltage measurements or null detection.

Electrical Characteristics of 400 cycle Converters

Driving Coil Requirements: 18 volts, 94 milliamperes, 400 cycles—10 per cent.

Contact Rating: SPDT switching. Nominal rating—6 volts to one microvolt. 1.0 milliamperes; maximum power 100 microwatts.

Switching Action: Each contact closed 55 per cent of each cycle. Contacts closed simultaneously 5 per cent of the time, twice each cycle.

Symmetry: Within 5 per cent.

Local Characteristics: Resistive or inductive.

Shielding: Shell and coil shield, both grounded through pin No. 2.

Vibration Resistance: Output voltage will vary less than 2 per cent, with rates of vibration from 0 to 10 g (gravity).

Phase Shift: Output voltage differs from that of driving voltage by 45 to 50 degrees.

Stray Pick-up: Electrostatic— 2×10^{-10} volts per ohm of input circuit impedance. Electromagnetic— 2×10^{-5} volts, constant to 2×10^{-6} volts.

For further information, send for Data Sheet No. 10.20-1.

BROWN SERVO AMPLIFIER SYSTEM

Comprises a converter (if the signal to be detected or measured is d-c); amplifier; and balancing motor. Ideal for null detection and correction of error signals. General characteristics are:

Amplifier No.	Input Impedance Ohms	Sensitivity, Volts	Over-All Voltage Gain	60-Cycle Output Current	60-Cycle Output Voltage
351921	400	2×10^{-6}	10^6	0-12	0-154
354547	7000	0.5×10^{-6}	4×10^6	0-12	0-154

* The amount of resistance in series with the input necessary to reduce the output voltage by one-half with the input voltage maintained constant.

For further information, send for Data Sheet No. 10.20-3.

• An amplifier with added stage of amplification and greatly increased sensitivity is also available. It produces motor drive from signals as low as 0.05 microvolt. Special features eliminate spurious signals resulting from thermal potentials and stray a-c pick-up.

For further information, send for Data Sheet No. 10.20-4.

BROWN 60-CYCLE BALANCING MOTOR

Totally enclosed and self-lubricated, ideal where positive positioning is required. Designed to have a tapered curve of speed versus voltage and, at the same time, maintain high torque at low speeds.

	27 RPM MOTOR	54 RPM MOTOR	162 RPM MOTOR
MAXIMUM TORQUE	Approx. 85 inch-ounces	Approx. 43 inch-ounces	Approx. 19 inch-ounces
MAXIMUM POWER	Approx. 6300 inch-ozs. per minute at approx. 17-18 rpm.	Approx. 67—inch-ozs. per minute at approx. 30-32 rpm.	Approx. 8150 inch-ozs. per minute at approx. 100 rpm.
POWER REQUIREMENTS	Line field—approx. 9.5 Watts. Amplifier field—approx. 4 Watts. Total power—approx. 13.5 Watts		

For further information, send for Data Sheet No. 10.20-2.

and components for a variety of applications

These products are representative of the thousands of modifications of the *ElectroniK* Potentiometer and the great numbers of Brown Electronic Components which are being utilized as precision measuring devices and as integral elements of various analytical systems. Perhaps your research program can benefit from such specialized instrumentation . . . your inquiry is invited. MINNEAPOLIS-HONEYWELL REGULATOR CO., Industrial Division, 4428 Wayne Ave., Philadelphia 44, Pa.

MINNEAPOLIS
Honeywell
BROWN INSTRUMENTS



First in Controls

• Important Reference Data

Write, today, for a copy of Research Bulletin No. 15-14 . . . "Instruments Accelerate Research".

How Low is a HIGH VACUUM?

You can't measure a working vacuum by *pressure* alone because *time* also is a big factor in any vacuum processing operation. To provide these two essentials of high vacuum — (1) the *required low absolute pressure* (2) in the *shortest possible time* — is the job for fast, dependable Kinney High Vacuum Pumps.

Fast — Kinney High Vacuum Pumps have the ability to save processing time by speeding up the tempo of your vacuum operations.

Dependable — Kinney High Vacuum Pumps have the ability and stamina to produce the vacuum you need, whether it's measured in fractions of an inch of mercury or fractions of a micron.

Remember, there's a Kinney Pump for every vacuum requirement, from the midget 2 cu. ft. per min. pump to the new giant 1600 cu. ft. per min. model. Send coupon today for new Kinney Bulletin V-51B. KINNEY MANUFACTURING CO., Boston 30, Mass. Representatives in New York, Chicago, Cleveland, Philadelphia, Houston, New Orleans, San Francisco, Seattle, Los Angeles.

FOREIGN REPRESENTATIVES: Gen'l Engineering Co., Ltd., Radcliffe, Lancs., England • Horrocks, Roxburgh Pty., Ltd., Melbourne, C. I. Australia • W. S. Thomas & Taylor Pty., Ltd., Johannesburg, South Africa • Novelectric, Ltd., Zurich, Switzerland • C.I.R.E. Piazza Cavour 25, Rome, Italy.

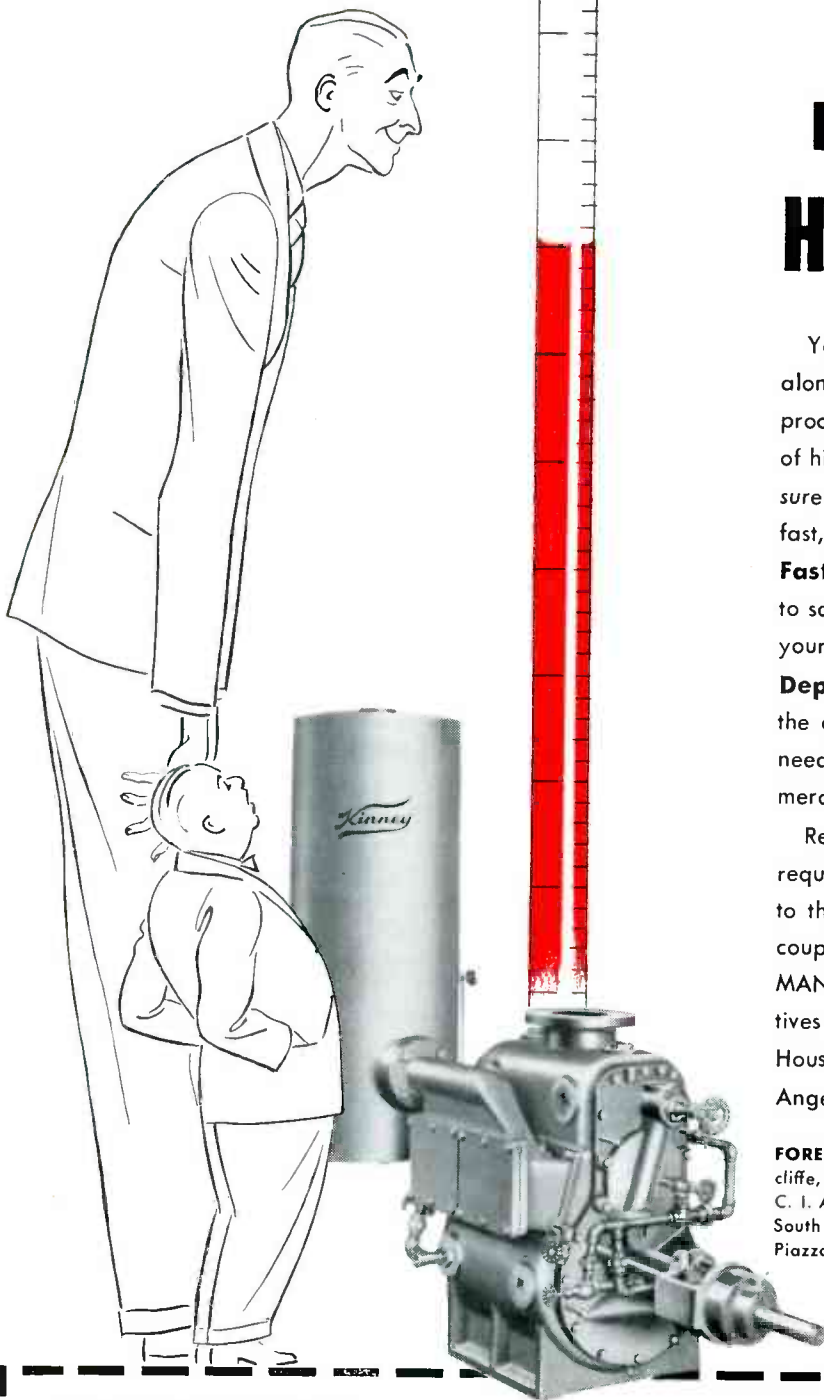

KINNEY MANUFACTURING CO.
3565 WASHINGTON ST., BOSTON 30, MASS.

Please send new Bulletin V-51B. Our vacuum problem involves:

- | | |
|---|--|
| <input type="checkbox"/> Vacuum exhausting | <input type="checkbox"/> Vacuum distillation |
| <input type="checkbox"/> Vacuum dehydration | <input type="checkbox"/> Vacuum metallurgy |
| <input type="checkbox"/> Vacuum coating | <input type="checkbox"/> Vacuum research |

Name..... Company.....

Address.....

City..... State.....



WTIC—HARTFORD

discovers

disc recorders

are still

a must

Studio engineering supervisor Albert Jackson (right) along with maintenance engineer Fred Edwards (below) planned and installed WTIC's new PRESTO disc-recording studio.



Originally many stations across the nation thought that the advent of the tape recorder meant the eventual death of the disc. But, it didn't turn out that way! Convinced of the continuing need for disc recording and faced with an increased load of disc work, WTIC—Hartford's 50 kw station—decided to augment its disc equipment.

Having received 12 years of constant service from their PRESTO 8-A disc machines, WTIC naturally turned to PRESTO for its new equipment . . . two new 8-DG recorders, 92-B amplifiers and 160-B equalizers, along with a central console mounted between the recorders. Housed in its own studio, the new equipment turned out more than 400 recordings the first two months and is estimated to save the station \$1,000 a year by cutting microgroove reference discs.

A wide range of WTIC activities, including agency program auditions, special gift records for VIPs appearing on the air, recordings of network programs originating at the station, as well as community service shows for other Connecticut stations, keep WTIC's disc equipment turning almost constantly . . . proof that disc recorders are still very much in the spin!



Export Division:
25 Warren Street, New York 7, N. Y.
Canadian Division:
Walter P. Downs, Ltd.,
Dominion Square Bldg., Montreal

wherever you go...

there's **PRESTO**



SLANT YOUR REQUIREMENTS TO ICA FOR MINIATURE

SLIP RING AND COMMUTATOR ASSEMBLIES

This ICA plant—brand new inside and out—contains the most modern and complete facilities available anywhere in the world for the exclusive production of Miniature Slip-Ring and Commutator Assemblies to precision standards. It is now in full scale production to meet your requirements in the fastest possible time at the lowest possible cost.

ICA Assemblies are produced under exclusive license by Electro Tec Corporation. They are manufactured by molding plastic blanks around the wire leads, then machining these blanks to the exact size and shape required, after which hard silver rings are electro-plated into the machined grooves. Final machining produces a one-piece assembly of extreme accuracy and free from the accumulated errors common in fabricated assemblies.

Before placing an order for assemblies of any other type, check with ICA on price and quality. Our new facilities offer exceptional advantages which should not be overlooked. Our engineering staff is at your service at all times for consultation.

TYPICAL SPECIFICATIONS:

Sizes: .045" to 24"
Cylindrical or Flat

Cross-sections: .055" to .060" or More

Finish: Polish to 4 Micro-Inches or Better

Breakdown: 1000 V Hi-Pot Inter-Circuit

Ring Hardness: 60 to 70 Brinell

Rotation Speeds: To Over 12000 RPM

Surface Protection: Palladium and Rhodium or Gold Prevent Tarnish, Minimize Wear

INSTRUMENT CORPORATION OF AMERICA

BLACKSBURG • VIRGINIA

UNDER EXCLUSIVE LICENSE OF ELECTRO TEC CORPORATION

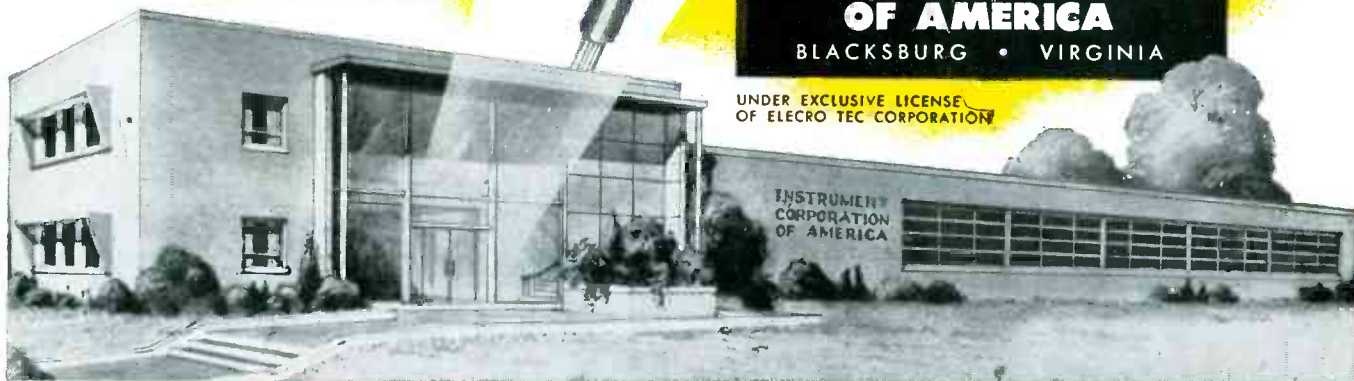

For GAS SWITCHING TUBES

TR-ATR-PRE TR *and*

MICROWAVE COMPONENTS *Consult...*

Bomac

Bomac has available an extensive line of TR, ATR, Pre TR and attenuator tubes covering all the frequency bands and power levels in use. Many types are in high level production; specialized types can be supplied on short notice.

The Bomac engineering staff includes personnel who have been associated with TR development since the inception of Microwave Radar and have made major contributions to TR development. Their accumulated experience is at your disposal.



K BAND

1B26
1B36
BL-11

X_b BAND

1B50
1B51



X BAND

BL-3
1B24A
1B35
1B37
1B60
724B
6038
ATR388
1B63A



S BAND

1B27 1B57
1B38 1B58
1B44 1B62
1B52 721B
1B53 5792
1B54 5793
1B55 5853
1B56 ATR387

L BAND

1B23
1B40

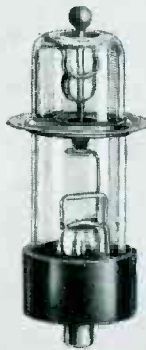

**PRESSURIZING
WINDOWS**

BL105
BL106
BL107
BL112
BL114



Catalog available on request. Write (on your company letterhead) Dept. C, Bomac Laboratories, Inc., Salem Road, Beverly, Massachusetts.



WE INVITE YOUR
INQUIRIES REGARDING

- ENGINEERING
- DEVELOPMENT
- PRODUCTION

Bomac Laboratories, Inc.

BEVERLY · MASSACHUSETTS



ROLLING ELECTROLYTIC CAPACITORS with "Scotch" Electrical Tape No. 42 at The Magnavox Company, Fort Wayne, Indiana.

WHAT'S NEW IN TV TAPES?

High-purity, stick-at-a-touch tape cuts condenser breakdowns at The Magnavox Co.

At last—a tape that won't corrode electrolytic condensers! It's "Scotch" Electrical Tape No. 42—a tape with extremely low chloride content, and it's now proving its worth at The Magnavox Company, Fort Wayne, Indiana. Condenser breakdowns caused by usual wrapping methods have been sharply reduced.

This "Scotch" Electrical Tape is only one of many "Scotch" Electrical Tapes designed to give you lower costs, faster production and more dependable results.

Over 30 of these stick-at-a-touch tapes are described in a new booklet we'd like you to have as a reference. The booklet is titled "Tapes for Television," and it gives you *facts* like dielectric strength, caliper, type of backing and mechanical strength of tapes that can save you real money.

Write for your copy of this handy booklet today! Use coupon below for immediate attention.

Minnesota Mining & Mfg. Co.
Dept. E22, St. Paul 6, Minnesota



Please send a copy of "Tapes for Television."

Name.....

Firm.....

Address.....

City..... Zone..... State.....



The term "SCOTCH" and the plaid design are registered trade marks for the more than 100 pressure-sensitive adhesive tapes made in U.S.A. by Minnesota Mining & Mfg. Co., St. Paul 6, Minn.—also makers of "SCOTCH" Sound Recording Tape, "UNDERSEAL" Rubberized Coating, "SCOTCHLITE" Reflective Sheeting, "SAFETY-WALK" Non-slip Surfacing, "3M" Abrasives, "3M" Adhesives. General Export: Minn. Mining & Mfg. Co., International Division, 270 Park Avenue, New York 17, N. Y. In Canada: Minnesota Mining & Mfg. of Canada, Ltd., London, Canada.

C-D always the Leader IN A.C. MOTOR CAPACITORS!



Year after year, more motor manufacturers use more
Cornell-Dubilier A.C. motor capacitors than any
other. The reason: a great record of trouble-free service in
the field! Filled with C-D's world-famous Dykanol, and
conservatively rated for extra dependability. Dept. K-22,
Cornell-Dubilier Electric Corp., South Plainfield, N. J.



CONSISTENTLY DEPENDABLE
CORNELL-DUBILIER
CAPACITORS

PLANTS IN SOUTH PLAINFIELD, N. J.; NEW BEDFORD, WORCESTER, AND
CAMBRIDGE, MASS.; PROVIDENCE, R. I.; INDIANAPOLIS, IND.; FLOQUAY
SPRINGS, N. C.; AND SUBSIDIARY, THE RADIART CORP., CLEVELAND, OHIO

Availability is



in resistors too!

A 100% increase in output of composition resistors—that's IRC's answer to current Government and Industrial needs! And this tremendous expansion is accompanied by fully mechanized step-ups in all other IRC resistor lines. In addition, licensees in Canada and Denmark supplement IRC capacity—while licensees in England, Australia and Italy serve our foreign markets. Even your urgent experimental and maintenance requirements can be met with little delay. For 'round-the-corner delivery of standard sizes and types, simply call your nearest IRC Distributor.



Visit IRC at
Booth #102
RADIO ENGINEERING SHOW
March 3-6

Where JAN Specifications are a problem, order IRC advanced Type BT Resistors. At $\frac{1}{8}$, $\frac{1}{4}$, 1 and 2 watts, these fixed composition units meet JAN-R-11 specifications, in all characteristics—actually surpass them in many! In BT's, the IRC filament-type element combines with exclusive construction features to provide a resistor of uncommonly low operating temperature and superior power dissipation. BT's are compact, lightweight, fully insulated, low in cost. IRC's recent production expansion assures greater availability than in any other critical period. Send for Data Bulletin B-1.

essential

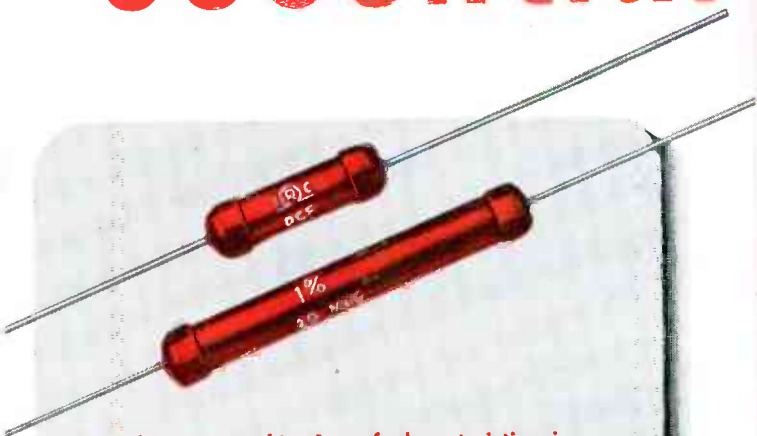

Where a combination of characteristics is essential in precision applications, you'll cut costs with IRC PRECISTORS. These deposited carbon units solve availability problems in high frequency applications, metering and voltage divider circuits—combine accuracy and economy where carbon compositions are unsuitable and wire wounds too expensive. We make the two sizes of PRECISTORS to customers' specifications, rather than to standard RTMA values—subject, of course, to minimum and maximum values for each type. Write for complete data in Catalog Bulletin B-4.

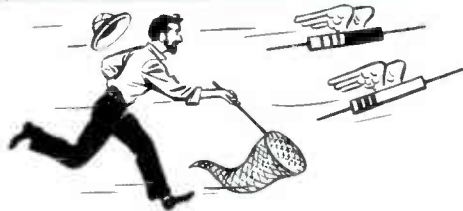

When experiments, pilot runs or maintenance demand standard resistors *double-quick*, you'll appreciate the advantages of IRC's Industrial Service Plan. This enables you to get prompt, 'round-the-corner service from the local stocks of your IRC Distributor. Call him for your minimum-quantity requirements. If you don't know him, we'll gladly send you his name and address.



When you need dependable small-size controls, specify IRC 1 1/4" Type Q Controls. New Type Q's are rugged and compact, yet increased arc of rotation permits the same resistance ratios used in larger IRC controls. Type Q's are characterized by low noise level, unusual durability and efficiency, negligible changes in resistance even after long exposure to humidity, adaptability to a great variety of small-space applications. Complete mechanization of production and testing assures uniformity of construction and performance—and affords greater availability. Bulletin A-1 gives full details.

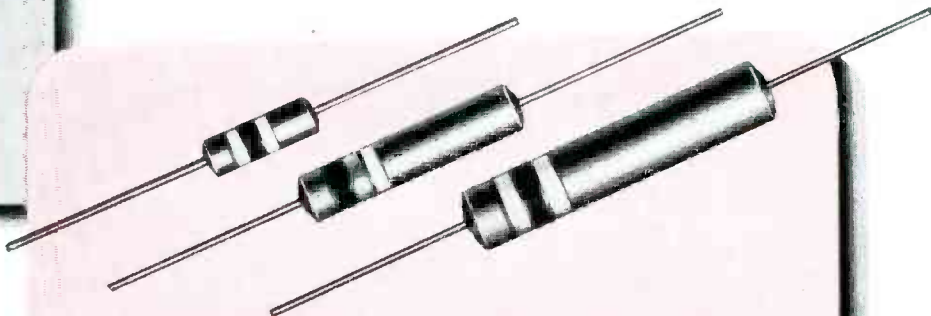

For exceptional stability and economy in low range applications, choose IRC Type BW Insulated Wire Wound Resistors. Uniformly wound and completely insulated, these compact units have excellent performance records in meters, analysers, low-range bridge circuits, high stability attenuators and similar applications. Type BW's are supplied in standard RTMA ranges, tolerance $\pm 10\%$ standard—values of 10 ohms and above in $\pm 5\%$. Available also in matched or balanced pairs. Full data in Catalog Bulletin B-5.

Power Resistors • Voltmeter Multipliers
Insulated Composition Resistors
Low Wattage Wire Wounds
Volume Controls • Precision Wire Wounds • Deposited Carbon
Precistors • Ultra HF and High Voltage Resistors • Insulated Chokes
Voltage Dividers.



Wherever the Circuit Says

INTERNATIONAL RESISTANCE COMPANY

401 N. Broad Street, Philadelphia 8, Pa.

In Canada: International Resistance Co., Ltd., Toronto, Licensee

INTERNATIONAL RESISTANCE COMPANY
403 N. Broad Street, Philadelphia 8, Pa.

Send me additional data on items checked below:

- Advanced BT Resistors Type Q Controls
 Deposited Carbon PRECISTORS Type BW Wire Wound Resistors
 Name and address of local IRC Distributor

NAME _____

TITLE _____

COMPANY _____

ADDRESS _____

CITY _____ ZONE _____ STATE _____



DESIGNER'S

VERSATILE G-E AMPLISTATS PROVIDE HIGH-GAIN DC AMPLIFICATION



1-va amplistat

- INSTANT STARTING—No warm-up time
- STATIC OPERATION—No moving parts, no maintenance
- DURABILITY—Unaffected by moderate shock or vibration
- LONG LIFE—Will operate indefinitely without attention

As part of a continuing effort to better serve the electronics industry, General Electric has recently enlarged its line of amplistats (self-saturating magnetic amplifiers). These remarkable units, for amplifying small d-c signals from relatively low-impedance sources, can be profitably applied to many control and instrumentation circuits both in conjunction with, and in place of, electronic equipment.

At present, G-E amplistats are available in three component ratings and one "educational" or laboratory research device. G-E engineers will be glad to aid and advise in developing complete amplification systems around these products.

1-VA AMPLISTAT is easy to connect and remove because it's mounted on a standard tube-type base. Maximum power gain is over 2000 watts per watt. Response time is $\frac{1}{8}$ sec or less. Operates directly on 40-volt, 60-cycle a-c. Dimensions, 2 x 2 x 2 $\frac{5}{8}$ in. high including octal base. Weight, 11 oz. Further details in Bulletin GEC-784.

40-VA MODEL has selenium rectifiers and four separate control windings. Maxi-

mum power gain is 15,000 w/w. Response time is 2 sec, corresponding to maximum-gain conditions. No special power supply—operates directly on 115-volt, a-c. Dimensions, 5 x 7 $\frac{3}{4}$ x 4 $\frac{5}{8}$ in. Weight 7 lb. See Bulletin GEC-790.

400-CYCLE UNITS are push-pull output, d-c linear amplifiers with three separate d-c input windings. Designed as the first and second stages for thermocouple signal amplifiers meeting aircraft requirements, they're also applicable to many other amplification problems.

Available for power supplies rated 15 or 30 volts, they have a maximum power gain of 2050 w/w. Response time ranges from 0.0036 to 0.0177 sec. Output ratings, 20 to 30 milliamp. Dimensions, 3 $\frac{3}{32}$ x 2 $\frac{1}{16}$ x 2 $\frac{3}{4}$ in. Weight, 14 oz. For further information write to *Special Products Sales, General Electric Company, Schenectady 5, N. Y.*

"EDUCATIONAL" AMPLISTAT is useful in laboratories for experimental work and for studying new circuits. Operates directly from 115-volt, 60-cycle power. Gain is up to 25,000 watts per watt. Output is 1.0 amp continuous. Get more details in Bulletin GEC-599.



40-va amplistat



Educational amplistat



400-cycle amplistat

DIGEST

TIMELY HIGHLIGHTS ON G-E COMPONENTS

HOLD VOLTAGE STEADY—OR ADJUST IT PRECISELY—WITH G-E INDUCTROLS

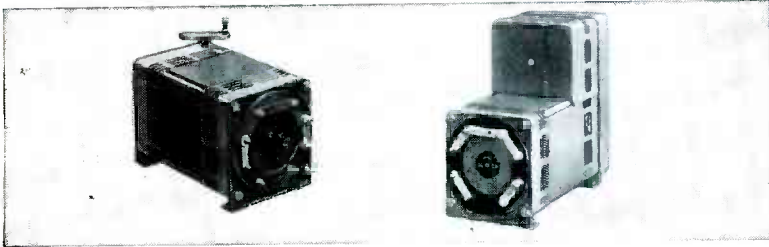

For precise and dependable stepless voltage regulation or variation it's G-E inductrols. These single-phase units are available in ratings from 3 to 240 kva for circuits 600 volts and below. Motor-operated units, used with automatic control,

maintain voltage within narrow limits regardless of line-voltage variation. Hand-operated models provide smooth and precise voltage adjustment for instrument calibration, rectifier control, and similar uses. Check Bulletin GEC-795.

G-E SELSYNS INDICATE POSITION—CONTROL MOTION

G-E selsyn transmitters and receivers provide automatically synchronized indication or control at one location with respect to an initial remote reference point. Built for accurate, economical, continuous service, they can be used to indicate angular or linear movement, or to control the motion of a device by controlling its actuating element. Two types are available—general purpose, for accuracy within ± 5 deg; and high accuracy, ± 1 deg. See Bulletin GEA-2176.



CONTROL WIRING SIMPLIFIED WITH G-E TERMINAL BOARDS

You get positive electrical connections without soldering using G-E Type EB-6 terminal boards fabricated from strong, durable molded Textolite* parts. To facilitate marking, reversible marking strips are white on one side, black on the other. Boards have 4 to 12 poles. Rated 30 amp, 600 volts. Complete details are contained in Bulletin GEA-1497.



*Reg. Trade-mark of General Electric Co.



EQUIPMENT FOR ELECTRONIC MANUFACTURERS

A partial list of the thousands of items in the complete G-E line. We'll tell you about them each month on these pages.

Components

Meters and instruments	Timers
Capacitors	Indicating lights
Transformers	Control switches
Pulse-forming networks	Generators
Delay lines	Selsyns
Reactors	Relays
*Thyrite	Amplidynes
Motor-generator sets	Amplistats
Inductrols	Terminal boards
Resistors	Push buttons
Voltage stabilizers	Photovoltaic cells
Fractional-hp motors	Glass bushings
Rectifiers	Dynamotors

Development and Production Equipment

Soldering irons
Resistance-welding control
Current-limited high-potential tester
Insulation testers
Vacuum-tube voltmeter
Photoelectric recorders
Demagnetizers

General Electric Company, Section C667-18 Schenectady 5, N. Y.

Please send me the following bulletins:

Indicate: for reference only

for planning an immediate project

- GEA-1497 Fabricated Terminal Boards
- GEA-2176 Selsyns
- GEC-599 Educational Amplistat
- GEC-784 One-Volt-Ampere Amplistat
- GEC-790 Forty-Volt-Ampere Amplistat
- GEC-795 Single-Phase Inductrols

Name

Company

Address

City State

GENERAL ELECTRIC

It's No Top Secret

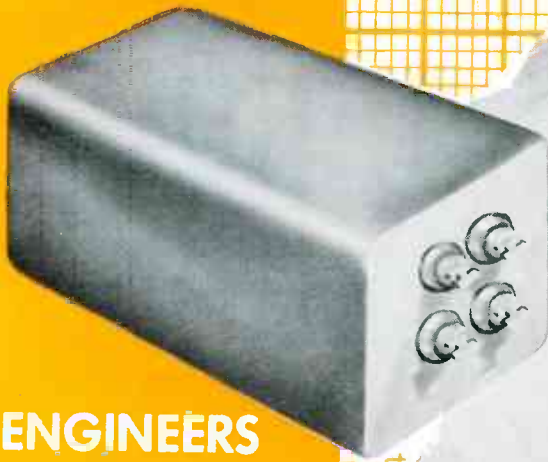

ENGINEERS
SPECIFY
Burnell
TOROIDAL COIL
Filters

FOR ALL MILITARY
APPLICATIONS

FACSIMILE

TELETYPE

GUIDED MISSILES

TELEMETERING

AIRCRAFT LANDING
SYSTEMS

CARRIER TELEGRAPH

TELEPHONE

CONTROL EQUIPMENT

SONAR

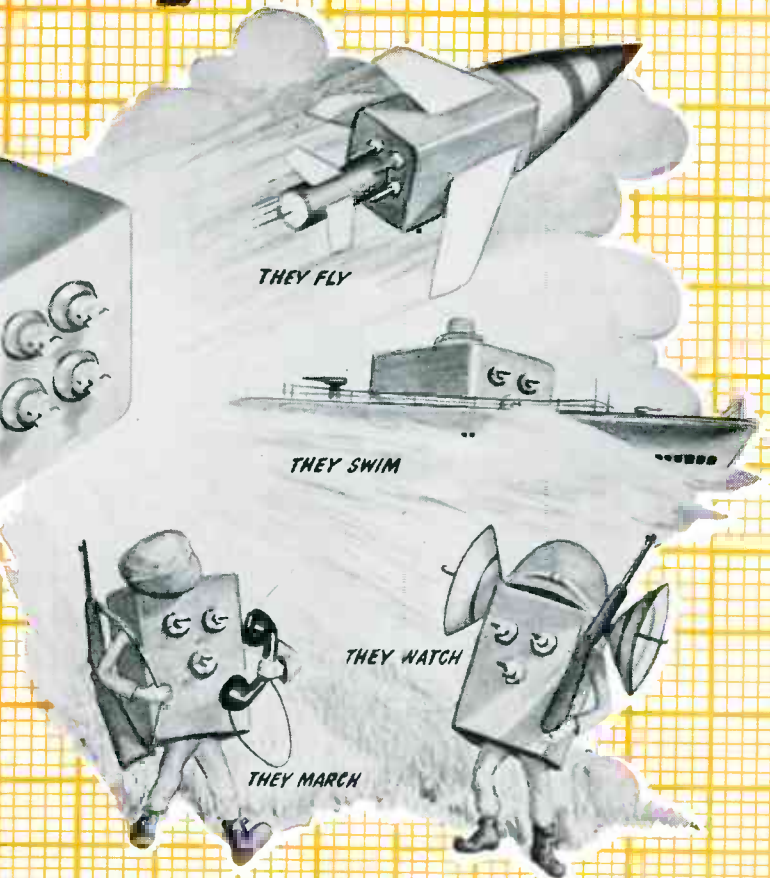

THE VARIED AND OFTEN UNUSUAL APPLICATIONS THAT HAVE BEEN FOUND FOR TOROIDS AND FILTERS IN MILITARY ELECTRONICS HAVE KEPT OUR ENGINEERING STAFF CONSTANTLY ON ITS TOES. EVERY DAY WE ARE CONFRONTED WITH THE TECHNICAL PROBLEMS OF OUR CUSTOMERS WHO ARE TRYING TO MEET THE DEMAND FOR SMALLER, LIGHTER AND MORE SERVICEABLE EQUIPMENT. FORTUNATELY OUR INGENUITY AND EXPERIENCE HAS SERVED US IN GOOD STEAD IN THE DEVELOPMENT OF FILTERS TO MEET THESE DEMANDS. CONSEQUENTLY IT IS WITH MORE THAN A LITTLE PRIDE THAT WE SEE OUR PRODUCTS SPECIFIED BY MORE AND MORE ENGINEERS WHO CANNOT BUT REALIZE THAT IN THE DESIGN OF QUALITY EQUIPMENT THE "BILL OF MATERIALS" SHOULD INCLUDE BURNELL PRODUCTS.



Burnell & Company

YONKERS 2, NEW YORK

CABLE ADDRESS "BURNELL"

EXCLUSIVE MANUFACTURERS OF COMMUNICATIONS NETWORK COMPONENTS

HOW TO HELP BRITAIN

...and Ourselves

The purpose of this editorial is to help Winston Churchill obtain the aid Britain needs

- (1) to weather her present financial crisis, and
- (2) to avoid a chronic recurrence of such crises.

This is not a philanthropic purpose.

Britain is our staunchest ally in the free world's continuing fight for survival. She cannot perform her role effectively if she is broke, or if she careens from one financial crisis to another.

Then, too, a nation such as ours—committed to private enterprise as a way of economic life—has a special interest in helping Winston Churchill to help Britain. His administration is relatively friendly toward private enterprise. Should he fail, he would be replaced promptly by a Socialist government more hostile than ever. And that would weaken the standing of private enterprise in the free world.

Cause of the Crisis

It is the drive of the Western World under our leadership to rearm against Russian aggression that has precipitated Britain's financial crisis. It set off a scramble for raw materials from which armaments could be made, and for many other materials that might be

short in the event of war. So the prices of the things that Britain must import—mostly raw materials—have been boosted more than the prices of things she can export—mostly finished products. That leaves Britain short of funds to pay for essential imports. This difficulty increases as the necessity becomes more urgent to divert industrial effort from production for export to production for security.

The Basic Trouble

Although Britain's immediate crisis was touched off by the rearmament drive of the Western World, her basic affliction is one from which she has suffered since the end of World War II. Stated in its simplest terms, Britain does not produce enough goods to pay her own way as one of the family of free nations.

For years this deficiency in home production was made up by income from shipping and overseas investment. But Britain had to sell a large part of her foreign investments to finance her heroic part in World War II. So her income from that source has been greatly reduced. And, in spite of an increase of about a third above prewar in her own production of goods and—thanks to a continued "austerity" program—a much larger increase in her exports, Britain still is not paying her own way.

Two Ways to Solvency

Britain has two ways to restore her solvency. One is to cut down on what is consumed—the belt-tightening process. The other is to step up British production.

To surmount the present crisis, Mr. Churchill has asked for some cutting down. He probably must ask for more.

Except as a stop-gap expedient, however, more cutting down of Britain's consumption is clearly a dangerous course. That would further depress a British standard of living which, not more than half as high as ours, already is too low. Politically such a course would grease the skids for Winston Churchill's administration, even now governing by a wafer-thin parliamentary margin. Also, as *The* (London) *Economist* remarks, the "lazy expedient of cutting trade" would result in "hurting other people and forcing them to take similar action"—by cutting the market for their products.

The Only Cure

The best and, in fact, the only way to help cure Britain's economic ills is to help Britain produce more. Here the technical possibilities are encouraging. On the average, the British industrial worker produces only about 40 percent as much a year as the American worker. That is a British estimate, made by Sir Ewart Smith.

Wider use of better industrial methods and modern tools and an infusion of the competitive incentive into British industry — to replace the cartel and other restrictive practices — would go a long way to narrow this wide gap in worker productivity. This is the consensus of experts on both sides of the Atlantic.

Since 1948 the Anglo-American Council on Productivity has done much to encourage output per man-hour in Britain and to foster this doctrine with both labor and management. But much yet remains to be done.

In the United States it is increasingly sug-

gested that before we give Britain any more economic aid we should insist that everything possible be done to exploit the technical possibilities of increased production. This emphasis on production is needed. But if we Americans were to impose upon the hard-pressed British people conditions that could be construed as an affront to a friendly and sovereign nation, we might well put into the hands of a masterful rabble-rouser such as Aneurin Bevan, the anti-American leader of the Labor Party's left wing, a campaign issue on which to maneuver himself into the Prime Ministership.

Churchill Can Insist

But Winston Churchill is not so handicapped as we should be in imposing prerequisites of further aid. As Britain's own, most honored leader he will raise no touchy questions as to Anglo-American relations if he insists that Britain have firm plans to cure her economic ills, plans sharply focussed on ways and means of increasing Britain's industrial efficiency.

By presenting a convincing plan to cure Britain's recurring crises through greater production, Mr. Churchill will greatly facilitate the process of getting the aid his country must have. He will also remove an increasingly dangerous element of dissension in Anglo-American relations—the feeling of many Americans that more aid to Britain is more money down the drain. The way to counter that feeling is to come up with a prescription for an economic cure, not a request for another economic poultice.

Technically, such a program is entirely feasible. It will perhaps be the supreme test of Winston Churchill's statesmanship to make it politically feasible as well.

In the interest of Britain, of the United States and of the whole free world, we wish him all success.

McGraw-Hill Publishing Company, Inc.

Strengthen the hand...

Today's need is for
more and better production

For this reason, Ersin Multicore Solder is important to your assembly line. Helps to meet and maintain urgent production schedules. Assures consistently high soldering speed, better coverage, fewer rejects, lower labor cost.

Strengthen your product, and your reputation, with Ersin Multicore, the original 3-core thin-wall solder. Conservatively speaking, you save dollars on the production line by spending pennies on Ersin Multicore Solder.



World's Finest
Cored Solder

ERSIN MULTICORE
more than meets
Federal Specifications

QQ-S-571-b

for SOLDER: SOFT
(TIN, TIN-LEAD, AND
LEAD-SILVER)

Contains only
virgin metals:
Tin — 99.75% pure
Lead — 99.97% pure

- Ersin Flux is a high-grade, water white rosin, homogeneously activated and exclusive to Multicore.
- Has vigorous fluxing action.
- Possesses non-corrosive and protective features of the original rosin. Leaves nothing but pure rosin after soldering.
- Non-corrosive even after prolonged exposure to humidity.
- Reduces surface tension of molten solder — wets metals rapidly.
- Non-toxic in use. Free from objectionable odor.
- Three separate cores of flux guarantee continuity of flux stream, preventing "dry" joints.
- Total percentage of flux to solder less than in many single cored solders.
- Multicore's unique properties make perfect joints possible on difficult metals and alloys, even if oxidized.

Address U. S. A. and Canadian inquiries to
MULTICORE SALES CORP.
164 Duane Street • New York 13, N. Y.

Inquiries regarding other territories to
MULTICORE SOLDERS LTD.
Mellier House, Albemarle Street • London, W. 1, England

New Edition! FREE—
Valuable booklet "Modern Solders" and
testing samples available on request.

For better products at lower cost-

SPECIFY

MYCALEX

**Glass-Bonded Mica
INSULATION**



- MOLDS AND MACHINES TO CLOSE TOLERANCES
- MOLDABLE WITH METAL INSERTS
- CAN BE TAPPED, THREADED, SLOTTED
- AVAILABLE IN RODS, SHEETS, SPECIAL SHAPES
- MOLDED IN PRACTICALLY ANY SHAPE OR SIZE
- LOW-LOSS FROM 60 CPS TO 24,000 MCS

MYCALEX glass-bonded mica insulation is the one highly adaptable, versatile insulating material that combines every desirable characteristic required in a modern dielectric. Although far superior to lower cost dielectrics, MYCALEX offers considerable advantages over many materials costing several times as much. MYCALEX is available in various

grades, each featuring specific characteristics to meet particular needs. Since proper application of the right grade of MYCALEX has resulted in simultaneous product improvement and lower cost in hundreds of instances, it's good business to check with MYCALEX before specifying sheet, rod, fabricated or molded insulation.

JAN APPROVED

MYCALEX 410 is approved fully as Grade L-4B under National Military Establishment Specification JAN-1-10, "Insulating Materials, Ceramic, Radio, Class L."

MYCALEX 400 is approved fully as Grade L-4A under National Military Establishment Specification JAN-1-10, "Insulating Materials, Ceramic, Radio, Class L."

Write for 20-Page Catalog Today!

A valuable compilation of engineering data and manufacturing information on electrical insulation that you'll surely want for your technical file. Request it today—no obligation.

CHARACTERISTICS

MYCALEX GRADE	400	410	410X
POWER FACTOR, 1 MC	0.0018	0.0015	0.012
DIELECTRIC CONSTANT, 1 MC	7.4	9.2	6.9
LOSS FACTOR, 1 MC	0.013	0.014	0.084
DIELECTRIC STRENGTH, volt/ml	500	400	400
VOLUME RESISTIVITY, ohm/cm	2×10^{15}	1×10^{15}	5×10^{14}
ARC RESISTANCE, seconds	300	250	250
MAX. SAFE OPER. TEMP., °C	370	350	350
WATER ABSORPTION % 24 hrs.	NIL	NIL	NIL



MYCALEX CORPORATION OF AMERICA

Owners of 'MYCALEX' Patents and Trade-Marks

Executive Offices: 30 ROCKEFELLER PLAZA, NEW YORK 20 — Plant & General Offices: CLIFTON, N. J.

THIS IS IT

★ **the NEW H-50
Rheostat**

★ **another
Hardwick, Hindle
ten-strike!**

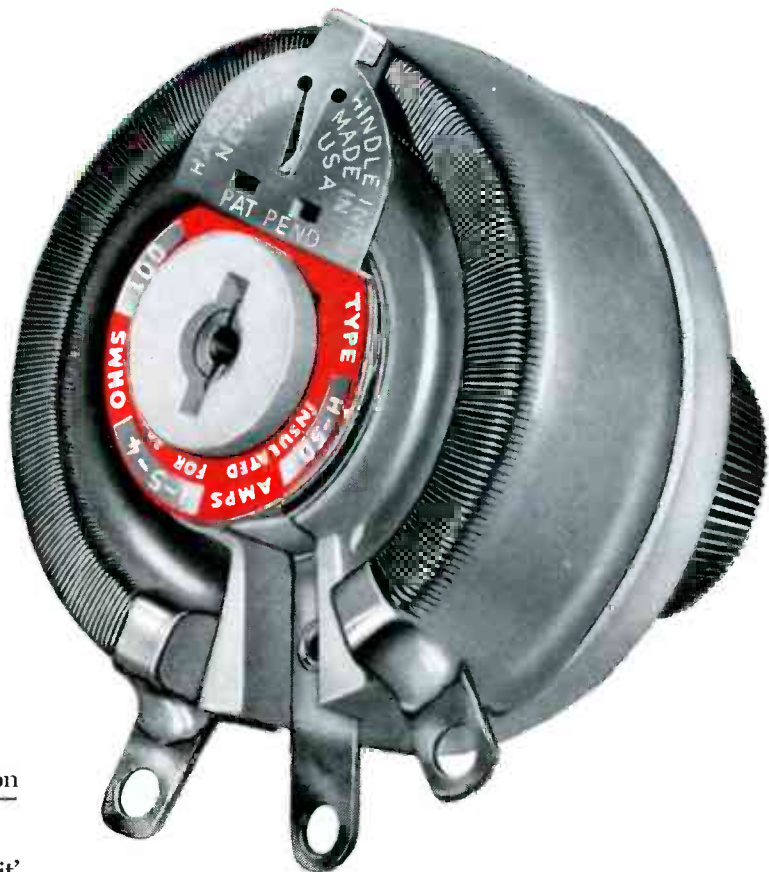

Instructions to our engineering department were:

“design a rheostat—completely new construction
if necessary—that embodies all features
essential to producing a rheostat that ‘can take it’
in the wide industrial field.”

They did—and this is it.

1. Of course it is bonded with our new blue-gray enamel coating—thermo-shock-proof—assuring greater protection under most rugged service—under extremes of humidity and abnormal atmospheric conditions.
2. Still greater safety factor—more resistant to excess heat and shock.
3. Still higher terminal strength.
4. New trouble free construction—minimum number of parts—uniform torque, adjustable pressure, smoother electrical control, etc.

And please note; this new H-50 is designed to comply with current standards of:

- (a) Military Specifications JAN-R-22.
- (b) Underwriters' Laboratories.
- (c) R.T.M.A.
- (d) N.E.M.A.

Send today for our new bulletin, containing additional information.

HARDWICK, HINDLE, INC.

Rheostats and Resistors

Subsidiary of

THE NATIONAL LOCK WASHER COMPANY

Established 1886

NEWARK 5, N. J., U.S.A.

The mark of quality for



more than half a century

How to use **GLOBAR** **TYPE BNR** **RESISTORS** to advantage

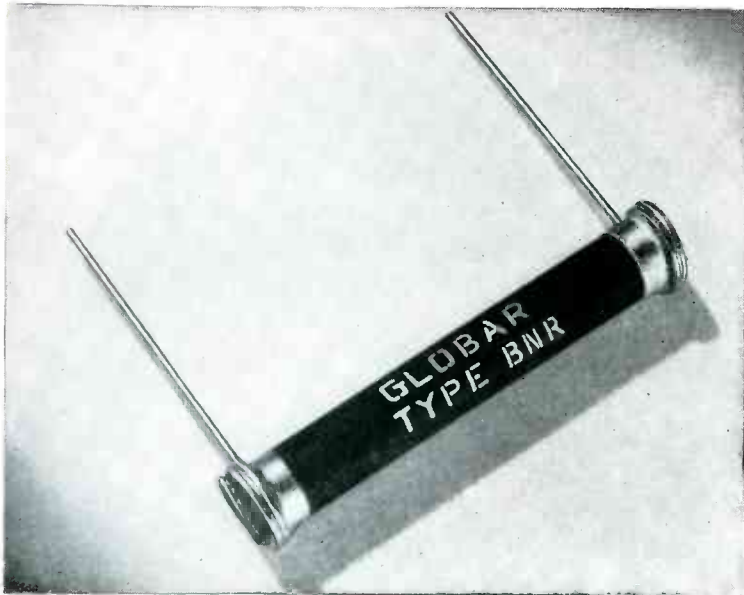

● The unusual characteristics of GLOBAR type BNR ceramic resistors make them practical for a diverse number of advantageous uses. Charted here are five typical applications where these resistors are being used to advantage at present.



Our Bulletin GR-2 contains detailed engineering data which may well suggest applications in your own products. It will give you facts that will help you decide how these ceramic resistors can be of value to you. Let us send you a copy. Write Dept. E L 87-101, The Carborundum Company, GLOBAR Division, Niagara Falls, N. Y.

APPLICATION	RESULT
Oil burner ignition transformer	High voltage feed back into line is prevented.
Small motors	Arcing of governor contact points is greatly decreased.
Rectifier circuits	Peak voltages are limited thus stabilizing circuits.
Electronic devices	Successful use in voltage control circuits.
DC Circuits	Solenoid valve coils are protected.

GLOBAR Ceramic Resistors

BY CARBORUNDUM

TRADE MARK



"Carborundum" and "Globar" are registered trademarks which indicate manufacture by The Carborundum Company, Niagara Falls, N. Y.

87-101

CHOOSE THE TUBE ALL INDUSTRY IS BUYING!

GL-5545 Thyatron sales have climbed spectacularly since introduction. Their sharp up-curve is proof of the tube's wide acceptance, of its brilliant performance. Make users' enthusiasm *your* guide . . . specify the efficient, extra-long-lived GL-5545 in your new d-c-motor or other control circuit!

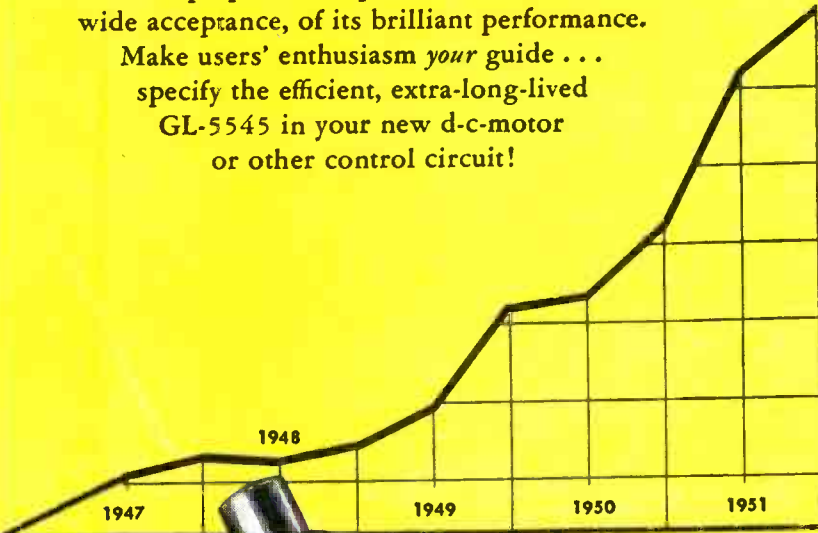

COMPARE! Why is the GL-5545 showing its heels to similar types? Compare this G-E control tube point-by-point with other-make thyatrons rated the same capacity:

CHARACTERISTIC	GL-5545	TUBE "A"	TUBE "B"	TUBE "C"
Avg current	6.4 amp	Same	Same	Same
Peak current	80 amp	LOWER	LOWER	LOWER
Fault current	1,120 amp	LOWER	LOWER	LOWER
Max voltage, peak forward	1,500 v	LOWER	LOWER	LOWER
Max voltage, peak inverse	1,500 v	LOWER	LOWER	LOWER
Ambient temp range	-55 to +70 C	Same	LOWER	Same
Commutation factor*	130	LOWER	LOWER	LOWER
Snubber circuit needed?	No	YES	YES	YES
Shielded grid construction?	Yes	NO	NO	NO

*Commutation factor is the product of the rate of decay of current in amperes per microsecond just before commutation, and the rate of rise of inverse voltage in volts per microsecond just after commutation.

For complete performance facts . . . for application counsel . . . wire or write *Electronics Division, General Electric Company, Schenectady 5, New York.*



**GL-5545
6.4-amp THYRATRON**



GENERAL  ELECTRIC

What's in a Name?

Way back in 1922, the late Henry C. Gates, well known industrialist, decided to make the name GATES synonymous with service in the electronics field.

Today, 30 years later, it would be a rare exception to find anyone who does not know about GATES products.

One of the oldest manufacturers of electronic equipment in the world, the GATES RADIO COMPANY specializes in radio transmitting equipment of all types — AM, FM, TV, Communications, etc.

By so specializing — and through production efficiency — GATES is able to offer higher quality at more modest prices.

No job is too large or small, too complex or simple for GATES to tackle.

Because GATES itself manufactures a large number of the components that go into finished GATES equipment, designs are not assemblies built to the convenience of someone else's particular size of material.

This means GATES offers "custom-built" quality and efficiency at prices that pleasantly surprise.

All of these points are of outstanding importance to you — are specific reasons for wanting your transmitting equipment to bear that familiar and trusted name — GATES.

GATES PRODUCTS

- Commercial broadcasting equipment
- Commercial communications transmitting equipment
- Television transmitting equipment
- Frequency modulated transmitting equipment
- Mobile transmitting equipment
- Audio equipment including: broadcast, recording, public address
- Specially designed electronic instruments including: vibration fatigue apparatus, laboratory hearing aid equipment, recording equipment
- And many other items.



GATES RADIO COMPANY • MANUFACTURING ENGINEERS • QUINCY, ILLINOIS, U. S. A.

2700 Polk Avenue, Houston, Texas • Warner Building, Washington, D. C. • International Division, 13 E. 40th St., New York City
Canadian Marconi Company, Montreal, Quebec

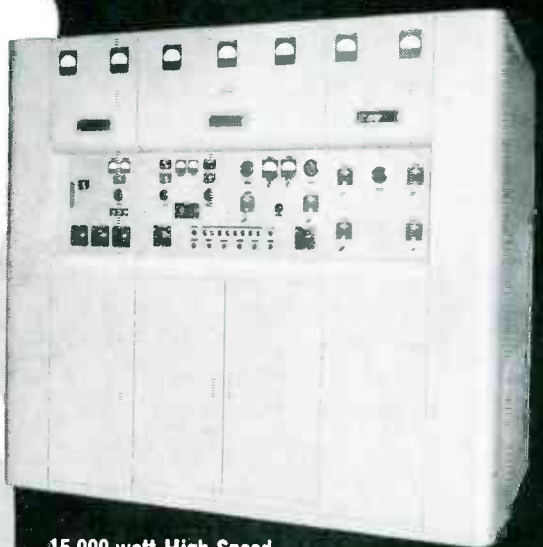

15,000 watt High Speed Telegraph Transmitter for Inter-continental service



Turntable

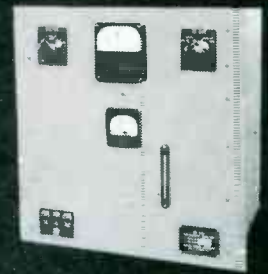

F.C.C. Approved Frequency Monitor

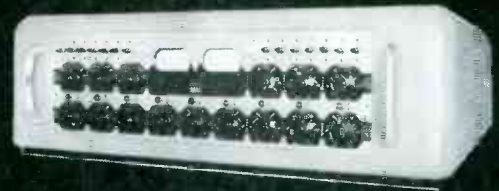

Dual Channel Speech Input System



GATES Supercab Co-ax

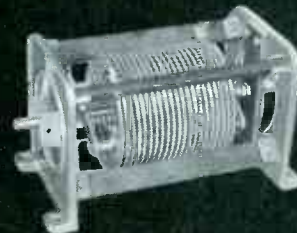

GATES Inductor



Tube Sockets for High Powered Tubes



THEY'RE BOTH IN THE KARP PICTURE

Beauty AND Utility

IN ENCLOSURES



Hand in hand they go, briskly pacing each project in our streamlined plant... symbols of the handsome *styling* and *utility* that engineers demand in modern "packaging" of electrical and mechanical equipment.

Under our big roof there lives a proud tradition: industry holds the name Karp synonymous with sheet metal fabrication of the highest order... in every category from simple to intricate.

This reputation we prize highly as a challenge that draws out our best efforts for every customer we serve, large or small. May we prove to you, too, that superior craftsmanship really costs less in terms of value received? Write for data book.

ANY METAL ANY GAUGE ANY SIZE
ANY QUANTITY ANY FINISH

• Trade Mark Registered

KARP METAL PRODUCTS CO., INC.

215 63rd STREET, BROOKLYN 20, NEW YORK

Specialists in Fabricating Sheet Metal for Industry



AMP

SOLDERLESS WIRING DEVICES for the electronics industry

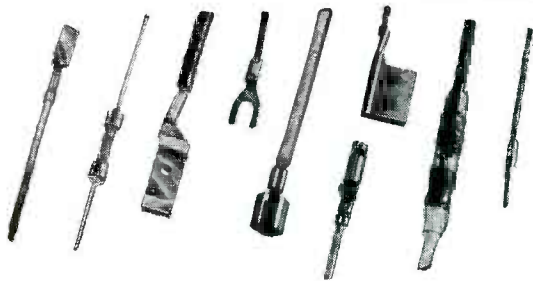

SPECIAL SOLDERLESS PINS, PLUGS, CONTACTS, AND CONNECTORS

Eliminate unnecessary parts, speed production, and reduce costs by designing with AMP'S special connectors in mind. We stock many unusual items, and can make new ones for your particular needs. These terminals are all applied to wire at high speed (from 2,000 to 4,000 per hour) by special AMP Automatic Machines. (see below)

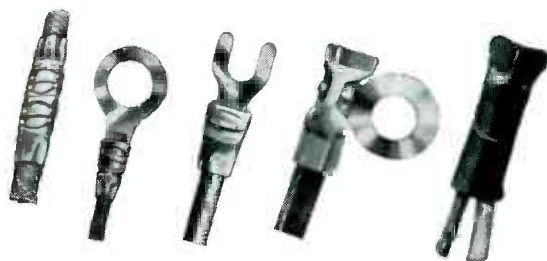

PRE-INSULATED DIAMOND GRIP Trade-Mark SOLDERLESS TERMINALS

No extra insulation sleeving necessary. One operation installs completely insulated, vibration-proof connection.

Plastic insulation of high dielectric properties is bonded to full-length copper sleeve—cannot slip or be removed. Min. breakdown voltage: 2500 volts D.C. in air at sea level. Will withstand high pressure crimp, temperatures at 350° F. for 10 hours without damage. Wire is supported to prevent fraying of wire insulation and torsional stress. Color-coded in wire size ranges from # 22 to # 10. Available in a variety of tongue shapes and connector styles.

U. S. Patents #2,410,321; 2,379,567; 2,405,111; 2,468,169; other U. S. Patents Pending.

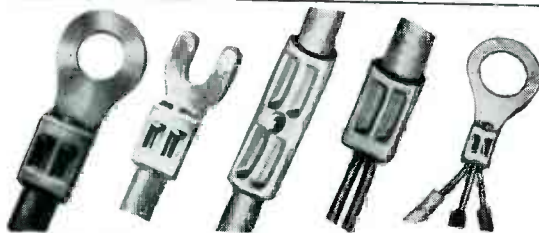

SOLISTRAND SOLDERLESS TERMINALS

Trade-Mark U. S. Patents Pending

Unique crimp makes this non-insulated terminal equally valuable for solid, stranded, square, or irregular shaped wire. Brazed seam. One piece construction of high conductivity pure copper, electro-tinned for corrosion resistance. Available in a wide variety of tongue shapes and connector styles from # 22 to # 4/0.

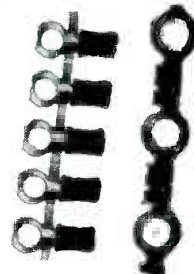
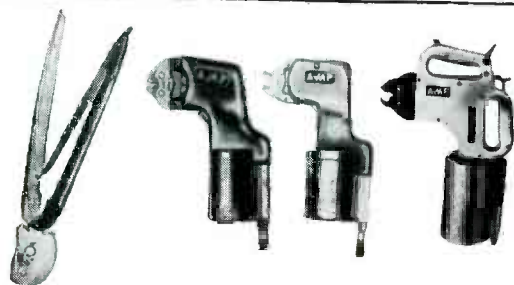

TOOLING

Whatever your production requirements, there is an AMP tool for the purpose. Strong, positive-action hand tools; light weight, compact pneumatic tools; bench presses; dies; hydraulic tools; and Automatic Machines. Terminals feed into AMP Automatic Machines in strip form to yield crimping rates up to 4,000 complete terminations per hour.

WRITE FOR COMPLETE "WIRE SIZE" CATALOG

98 page catalog lists
all AMP tools and terminals,
BY WIRE SIZE RANGES.
Send for your copy today!

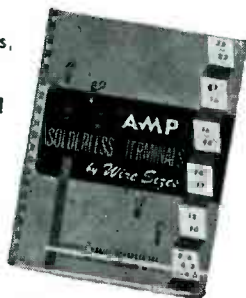

AMP Trade-Mark Reg. U. S. Pat. Off

AMP

AIRCRAFT-MARINE PRODUCTS INC. ELECTRONICS DIVISION

2100 Paxton Street, Harrisburg 10, Pa.

24 HOUR SERVICE
ON CATALOG MAGNETS!

INDIANA
Permanent Magnets
Specialists in "Packaged Energy" since 1908

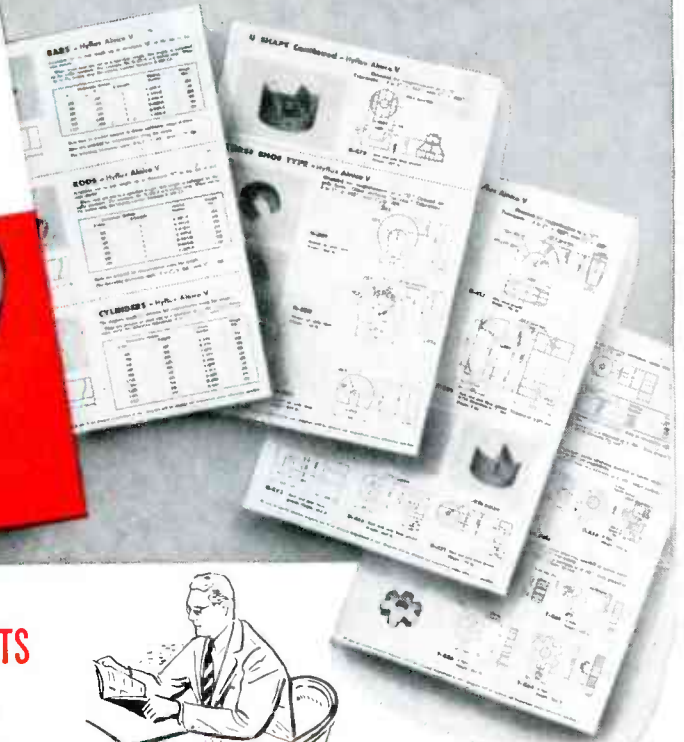

**WRITE FOR THIS CATALOG OF STOCK MAGNETS
FOR YOUR EXPERIMENTAL NEEDS**

Here's a handy reference, chock full of detailed permanent magnet information. If you are designing new products, or wish to improve present ones, this catalog will be of great value!

16% GREATER ENERGY

And, remember, all INDIANA permanent magnets described are available in INDIANA HYFLUX Alnico V—the permanent magnet material that offers an energy product averaging 5½ million BH max or more, with 5¼ million guaranteed!

Even though INDIANA HYFLUX Alnico V offers 16% greater energy product than regular Alnico V, it costs not a penny more!

INDIANA is the only manufacturer furnishing all commercial grades of permanent magnet alloys. You have a choice of cast, sintered, formed or ductile materials.



INDIANA engineers, with more than 30,000 successful permanent magnet applications to their credit, will be happy to help you with every permanent magnet problem.

*Write—or phone—INDIANA today!
Ask for Catalog No. 11A-2*

**INDIANA
PERMANENT
MAGNETS**

THE INDIANA STEEL PRODUCTS COMPANY

VALPARAISO, INDIANA • • • Sales Offices Coast to Coast

SPECIALISTS IN "PACKAGED ENERGY" SINCE 1908



MEPCO

Precision Resistors
... for Precision Electronics

MEPCO, INC., MORRISTOWN, NEW JERSEY



**WE'VE DECIDED NOT
TO HIDE OUR LIGHT
UNDER A BUSHEL**

THE

Phaostron

COMPANY

**ANNOUNCES THE MANUFACTURE OF
ELECTRICAL INDICATING INSTRUMENTS**

RUGGEDIZED
and
HERMETICALLY
SEALED



By license arrangements with Marion Electrical Instrument Company.

now has at its disposal all of the Marion know-how, procedure and experience.

personnel, trained at Marion in Manchester, New Hampshire, are now able to produce these instruments in quantity.

Your inquiries are invited.

**Environment Free
ELECTRICAL EQUIPMENT BY**

Phaostron

PHAOSTRON COMPANY 151 PASADENA AVENUE
SOUTH PASADENA, CALIFORNIA • CLEVELAND 6-2171

FOR MAXIMUM PERFORMANCE AND LONG LIFE
OF ELECTRICALLY-OPERATED EQUIPMENT

Invest in



STABILINE

Automatic

VOLTAGE REGULATORS



TYPE IE51002R



TYPE
IE51005



TYPE IE5101R



TYPE IE5101

Manufacturers faced with the need for increased production and lower costs are becoming extremely conscious of the importance of maintaining constant voltage to electrical apparatus. The Superior Electric Company's line of STABILINE Automatic Voltage Regulators offers equipment to suit the needs of each application. Two types are available: Type IE (Instantaneous Electronic) and Type EM (Electro-Mechanical).

STABILINE Type IE is a completely electronic unit with no moving parts . . . is used where instantaneous and extremely close correction is required. It maintains a constant output voltage regardless of line variations at no load, full load or any intermediate load. The output voltage is held to within ± 0.1 volts of nominal for wide line variations; within ± 0.15 volts of nominal for any load current change or load power factor change from lagging .5 to leading .9. Maximum waveform distortion never exceeds 3%.

Standard models are available in cabinets or for relay rack mounting in numerous ratings as listed below. In the event you have a special requirement involving other frequencies or ratings, SECO voltage control engineers will study your specific problem and make recommendations without obligation.

INSTANTANEOUS ELECTRONIC CABINET MODELS

Input Voltage Range	Output Voltage Range	Frequency In Cycles	Load Range In Amperes	Load Power Factor Range	Rated Output KVA	Type
95-135	110-120	60 \pm 10%	0 - 2.2	.5 lagging to .9 leading	0.25	IE51002*
195-255	220-240	60 \pm 10%	0 - 1.1		0.25	IE52002*
95-135	110-120	60 \pm 10%	0 - 4.5		0.5	IE51005*
195-255	220-240	60 \pm 10%	0 - 2.2		0.5	IE52005*
95-135	110-120	50 \pm 10%	0 - 4.5		0.5	IE51005*
195-255	220-240	50 \pm 10%	0 - 2.2		0.5	IE52005*
95-135	110-120	60 \pm 10%	0 - 8.5		1.0	IE5101*
195-255	220-240	60 \pm 10%	0 - 4.5		1.0	IE5201*
95-135	110-120	50 \pm 10%	0 - 8.5		1.0	IE5101*
195-255	220-240	50 \pm 10%	0 - 4.5		1.0	IE5201*
95-135	110-120	60 \pm 10%	0 - 22.0	2.5	IE5102*	
195-255	220-240	60 \pm 10%	0 - 11.0	2.5	IE5202*	
95-135	110-120	50 \pm 10%	0 - 11.0	2.5	IE5202*	
95-135	110-120	60 \pm 10%	0 - 43.5	5.0	IE5105	
195-255	220-240	60 \pm 10%	0 - 22.0	5.0	IE5205	

* Also offered in rack models.

REMEMBER, STABILINE TYPE EM (ELECTRO-MECHANICAL) UNITS ARE ALSO AVAILABLE. RATINGS FROM 2 TO 100 KVA. LITERATURE ON REQUEST.

There's a STABILINE Automatic Voltage Regulator for every need. Send today for literature and specific information. Write The Superior Electric Co., 202 Thure Avenue, Bristol, Conn.

THE SUPERIOR ELECTRIC CO.
BRISTOL, CONNECTICUT



POWERSTAT VARIABLE TRANSFORMERS • VOLTBOX A-C POWER SUPPLIES • STABILINE VOLTAGE REGULATORS

NEO-SIL
CORPORATION

*Master Pieces of Hermetic Sealing
— Proven to Eliminate Rejects!*

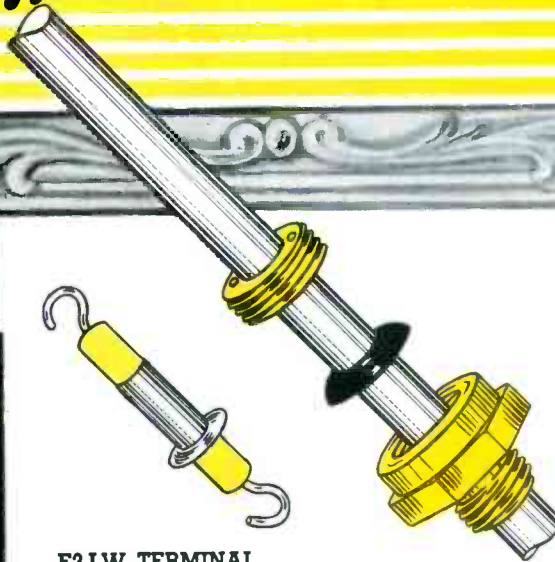

E3-LW TERMINAL

"E Series terminals are applicable on MIL requirements and will withstand thermal shock, vibrations, mechanical strains, and excessive pressures with no impairment of the seal or other functional characteristics. E-3LW terminals are now being used at 1000 psi static oil pressure and undergo 5000 psi tests."

**1/4" SHAFT
WATERSEAL BUSHING**

"Rotary Waterseal Panel Assemblies, with GRAF-SIL Packing Glands, have an excellent five year customer history on gas filled pressurized components. They are available for 1/4" shafts and for potentiometers and switch bushings."

PLUG IN TYPE HEADERS

MULTIPLE TYPE HEADERS

NEO-SIL HERMETIC SEALS
INDIV DUAL TYPE TERMINALS

TEST DATA

The result of the Electrical Testing Laboratories Inc., Report #330655, dated March 18, 1949, on this material shows the following:

Volume Resistivity at 800 Volts d-c
Room Temperature 25°C R.H. 30 percent
Megohm-inches 1.4 x 10⁶ ohm-centimeters 3.5 x 10¹²

Dielectric Constant and Dissipation Factor

Dielectric Constant	Dissipation Factor	Loss Factor
9.22 @ 60 cycles per second	.058	5.32
6.17 @ 1 megacycle per second	.0455	.28
5.35 @ 50 megacycles per second	0.20	1.1

Dielectric Strength at 60 cycles
Volts per mil — 370

Durometer Average — 80 ± 5
Temperature — Rated as a Class A material conservatively + 175° to -70° centigrade.

The Flashover Voltages indicated were taken at a temperature of 68° Fahrenheit, and 47% Relative Humidity.

"NEO-SIL's proven Hermetic sealing components will eliminate rejects resulting from breakage, strains, cracks, etc. Each NEO-SIL component is pressure checked at 25 psi — to meet military requirements and as applied to our units, NEO-SIL rubber will resist abusive temperature cycling, salt water, most acids and alkalis, and withstand high pressures and vacuums."

"In addition to the items illustrated above, NEO-SIL offers many other components, such as Hermetically Sealed Fuse Holders, Octal Type Plug In Headers, Multiple Pin Headers, Hermetically Sealed Cables, Hermetically Sealed Line Cords With Plugs For European use, Meter Gaskets, Panel Gaskets, Adapters (U.S. to Continental), Coil Forms, Crystal Contacts and other molded bakelite and NEO-SIL rubber units."

"Hermetically Sealed Fuse Holders are available for 3-AG and 4-AG fuses. These units are completely sealed from moisture with or without the cap or fuse inserted and are applicable for use on vacuum or gas filled units."

Your special problems are solicited.

NEO-SIL
CORPORATION

26 CORNELISON AVE., JERSEY CITY 4, N. J.

International Selenium Rectifiers

for unsurpassed
performance

STANDARD CELL SIZES	
B	1 1/4" x 1 1/4"
C	1 1/2" x 1 1/2"
D	3" x 3"
E	4 3/4" x 4 3/4"
F	5" x 6"
H	6 1/4" x 7 1/4"

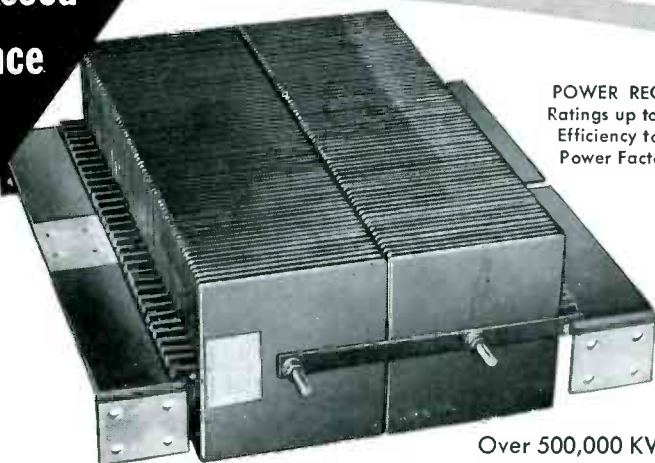

POWER RECTIFIERS
Ratings up to 250 KW
Efficiency to 87%—
Power Factor 95%

Over 500,000 KW, DC Power, is operated with *International Selenium Rectifiers*. A recent month's production included Rectifiers to supply 40 microamperes, 1,000 volts, and Rectifiers with a capacity of 140,000 amperes, 14 volts. Designed and built to meet Government Specifications. Manufactured for temperatures up to 100° C ambient—100% humidity. Owned and managed by Engineers who are specialists in the design and manufacture of Selenium Rectifiers. Submit your problems for analysis and we will be glad to offer our recommendations.



Photo-Electric Cells
Self-Generating Type
Output up to 600 microamperes
at 100 foot-candles illumination
and 100 ohms external resistance.



Hermetically Sealed Rectifiers
Cartridge Type—up to 60 ma.,
9,000 volts per cartridge.



High-Voltage Rectifiers
Cartridge Type—up to 60 ma.,
9,000 volts per cartridge.



Miniature Rectifiers
From 65 to 1,000 ma.



International
RECTIFIER CORPORATION

GENERAL OFFICES:
1521 E. Grand Ave.
El Segundo, Calif.
Phone El Segundo 1890

CHICAGO BRANCH OFFICE:
205 W. Wacker Dr.
Franklin 2-3889

THESE FOUR **CLARE RELAYS** offer designers *everything they demand from small size, lightweight relays!*

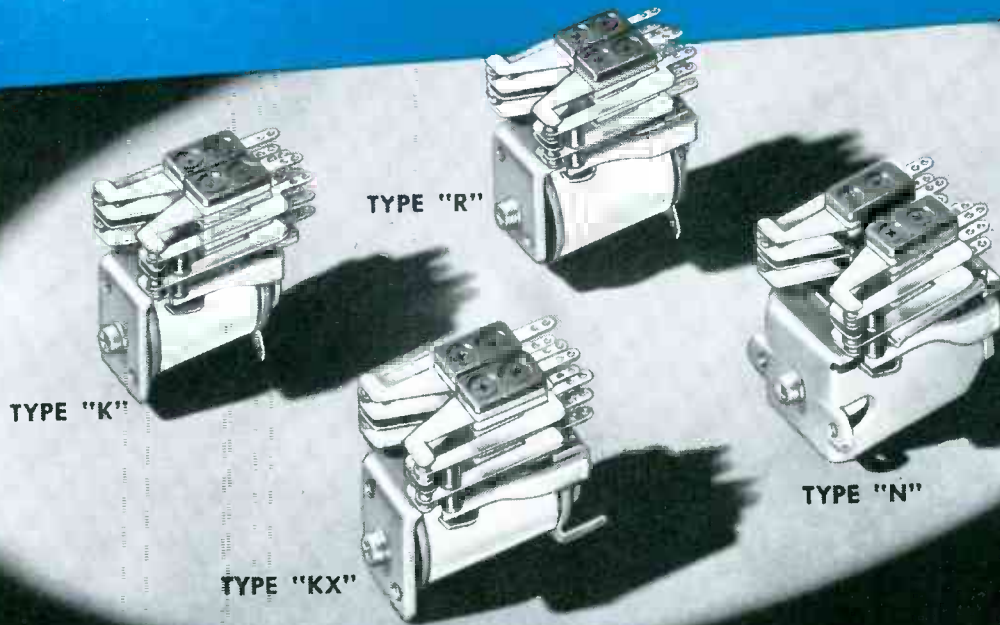

Special Features

which make these relays first choice of exacting design engineers

THE CLARE Type "K" RELAY

Fast operation—adequate contact pressure—high resistance to shock and vibration—long life—small size— $1\frac{1}{2}$ " x $1\frac{1}{4}$ " x $1\frac{1}{16}$ ".

THE CLARE Type "KX" RELAY

Same features as Type "K" but adds greater operating range and increased sensitivity by use of a slightly longer coil which can be safely wound to a maximum resistance of 8000 ohms. Size: $1\frac{3}{4}$ " x $1\frac{1}{2}$ " x 1".

THE CLARE Type "R" RELAY

Same basic features as Type "K" but adds still further sensitivity and operating range to the Type "KX" by the use of a coil which is not only longer but of increased diameter to provide even greater winding space. Size: $1\frac{7}{8}$ " x $1\frac{3}{4}$ " x 1".

THE CLARE Type "N" RELAY

Same basic features as Type "K" but designed for operation on extremely low power. This results from a close-coupled magnetic circuit, generous use of magnetic iron and unusually efficient coil design. Size: $1\frac{1}{8}$ " x $1\frac{1}{8}$ " x $1\frac{1}{2}$ ".

• The Clare Type "K" Relay was the first of the famous CLARE line of small, lightweight, telephone-type relays. It is still the mainstay of design engineers who must have superior relays to operate in extremely small space.

Its fast operation, adequate contact pressure, high resistance to shock and vibration, long life and complete all-around dependability have met many complex requirements.

The other three relays shown here supply all these advantages of the Type "K", but each adds certain other features to meet such specifications as a greater operating range, greater sensitivity or operation on extremely low power. All except the type "N" retain the reed armature suspension of special alloy which engineers recognize as one of the subtler reasons for the superior performance of these small CLARE Relays.

Clare sales engineers are located in principal cities to give you first hand information on the entire line of CLARE Relays . . . all of them designed to meet the most exacting relay requirements. Call them or write to C. P. Clare & Co., 4719 West Sunnyside Avenue, Chicago 30, Illinois. In Canada: Canadian Line Materials, Ltd., Toronto 13. Cable Address: CLARELAY.

All relays available in hermetically sealed form

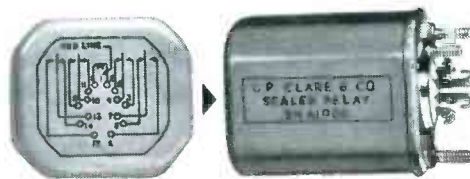

All of these four CLARE small relays are available enclosed in hermetically sealed steel containers. Connection diagrams are permanently imprinted on the base of the enclosure by silk screen process.

CLARE RELAYS

... First in the Industrial Field

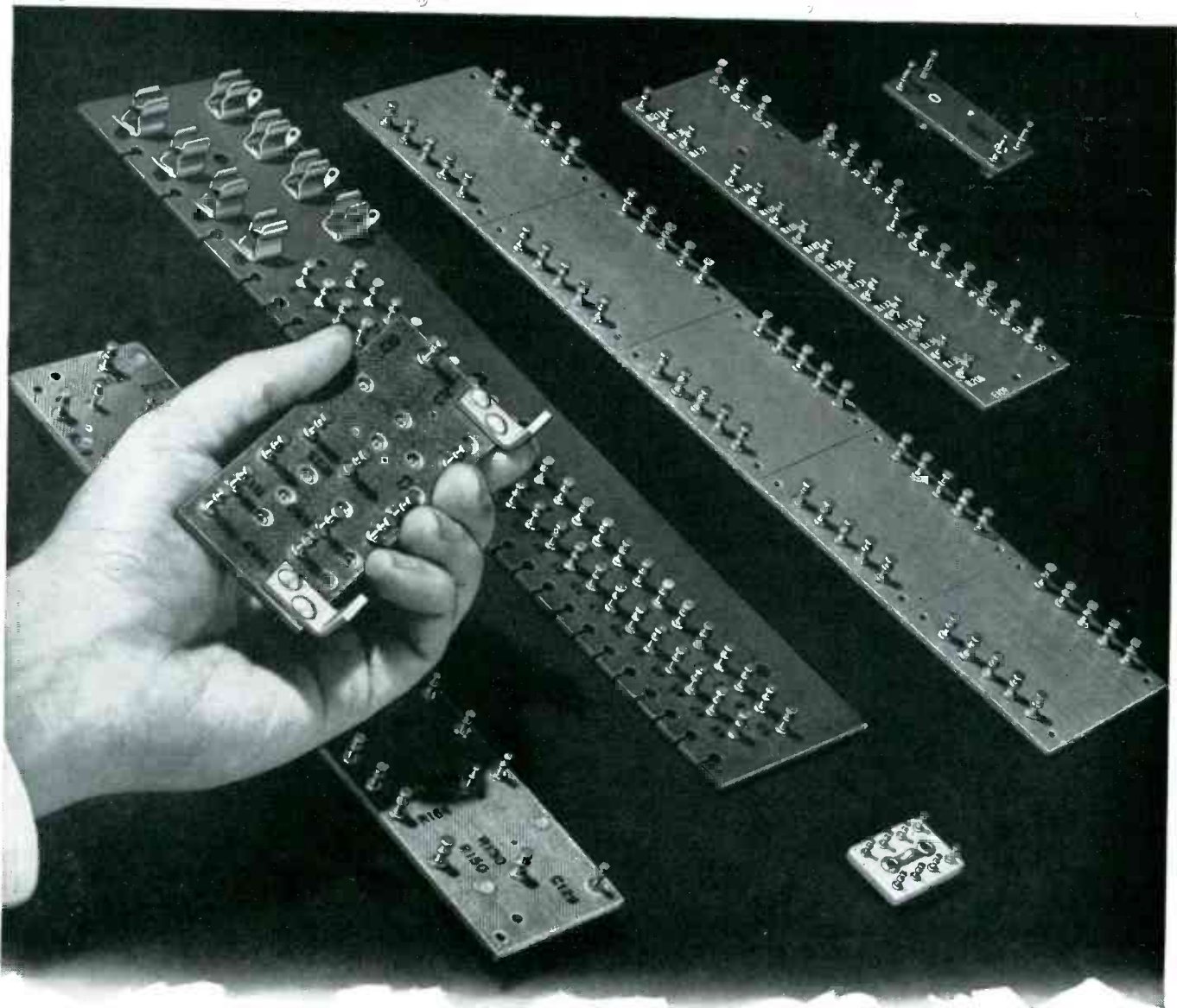

Name your needs in terminal boards ... we'll meet them accurately

The rigid specifications of government agencies and the armed forces need pose no problem to you. C.T.C. is in an excellent position to handle government sub-contracts for electronic parts and assemblies.

Our Custom Engineering Service is constantly supplying special terminal boards to the top names in electronics. These boards are built to severe government specifications, are fabricated of certified materials to fit the job. Among the specifications involved are: MIL-P-3115A, MIL-P-15037, MIL-P-15035A, MIL-P-15047, MIL-P-997A.

Boards can be made of cloth, paper, nylon or glass laminates (phenolic, melamine or silicone resin), and can be lacquered or varnished to specifications: JAN-C-178 and JAN-T-152. Lettering

and numbering is done by rubber stamping, silk screening, hot stamping, engraving. Inks used in rubber stamping contain anti-fungus and fluorescent additives.

Terminals, feed-throughs, mounting hardware and all other terminal board fixtures meet all applicable government specifications.

Standard "All Set" Boards, scribed for easy separation, for the assembly line and laboratory are

available in cotton fabric phenolic per specification MIL-P-15035A and in nylon phenolic per MIL-P-15047A.

For complete information write: Cambridge Thermionic Corporation, 437 Concord Avenue, Cambridge 38, Mass. West Coast manufacturers, contact: E. V. Roberts, 5014 Venice Blvd., Los Angeles, or 988 Market Street., San Francisco, Cal.

CAMBRIDGE THERMIONIC CORPORATION

custom or standard... the guaranteed components.

See our listing in Electronics Buyers' Guide



Complete Coverage!

2 to 700,000,000 cps



precision voltmeters for every ac voltage measuring need!



From 2 cps to 700 mc, there's an accurate, easy-to-use *-hp-* voltmeter for any voltage measuring job. You can choose from 5 precision instruments (including a battery-operated portable unit) the dependable *-hp-* voltmeter that exactly fills your need. Each gives you familiar *-hp-* operating characteristics of high sensitivity, wide range, broad applicability, time-saving ease of operation. *-hp-* also provides a complete line of voltmeter accessories—voltage dividers, connectors, shunts and multipliers—to extend the useful range of your equipment. For complete details, see your *-hp-* sales representative or write direct.

New *-hp-* 410B Vacuum Tube Voltmeter

Gives same wide range and flat response performance as *-hp-* 410A voltmeter, but sets new standard of mechanical convenience, ease of operation, minimum bench space. Readily detachable probe leads fit in handy compartment in new, compact, streamlined case. Special diode probe design places capacity of approximately $1.3 \mu\text{fd}$ across circuits under test. Shunt impedance is extremely high—10 megohms at low frequencies—thus circuits under test are not disturbed and true voltage readings are assured. New *-hp-* 410B provides 1 db accuracy from 20 cps to 700 mc; and may be used as a voltage indicator up to 3,000 mc. Also serves as audio or dc voltmeter or ohmmeter.

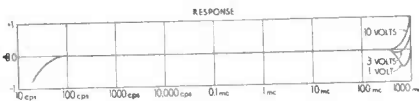

Response, *-hp-* 410B Voltmeter

INSTRUMENT	PRIMARY USES	FREQUENCY RANGE	VOLTAGE RANGE	INPUT IMPEDANCE	PRICE
<i>-hp-</i> 400A	General purpose ac measurement	10 cps to 1 mc	.005 to 300v 9 ranges	1 megohm 24 μfd shunt	\$185.00
<i>-hp-</i> 400B	Low frequency ac measurements	2 cps to 100 kc	.005 to 300v 9 ranges	10 megohms 24 μfd shunt	\$195.00
<i>-hp-</i> 400C	Wide range ac measurements High sensitivity	20 cps to 2 mc	.0001 to 300v 12 ranges	10 megohms 15 μfd shunt	\$200.00
<i>-hp-</i> 404A	Portable, battery operated	2 cps to 50 kc	.0005 to 300v 11 ranges	10 megohms 20 μfd shunt	\$185.00
<i>-hp-</i> 410B	Audio, rf, VHF measurements; dc voltages; resistances	20 cps to 700 mc	0.1 to 300v 7 ranges	10 megohms 1.3 μfd shunt	\$245.00



-hp- 400C Vacuum Tube Voltmeter

General purpose precision voltmeter offering wide range, high sensitivity, high stability. Quick-reading linear meter scale shows RMS volts or dbm direct from -72 dbm to $+52 \text{ dbm}$. Broad usefulness includes direct noise or hum measurements, transmitter and receiver voltages, audio, carrier or supersonic voltages, or power gain. Also may be used as 54 db amplifier to increase signal level to oscilloscopes, recorders, power amplifiers, etc.

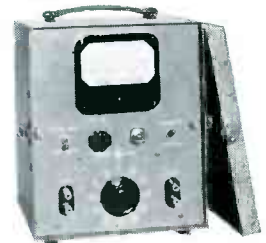

-hp- 404A Battery-Operated Voltmeter

Precision vacuum tube instrument for general voltage measurement where ac power is not available. Compact, portable, splash-proof—ruggedly constructed for field operations. Wide voltage range permits all types of measurements including remote broadcast line and carrier checks, strain gauge system tests, telemetering and geophysical circuit measurements, etc. In the laboratory, offers completely hum-free measurements of very low noise level.

HEWLETT-PACKARD CO.

2251A Page Mill Rd. • Palo Alto, Calif., U.S.A.

Sales representatives in principal areas

Export: Frazer & Hansen, Ltd.

San Francisco • New York • Los Angeles

HEWLETT-PACKARD  INSTRUMENTS

the truth about Dow Corning Silicones...

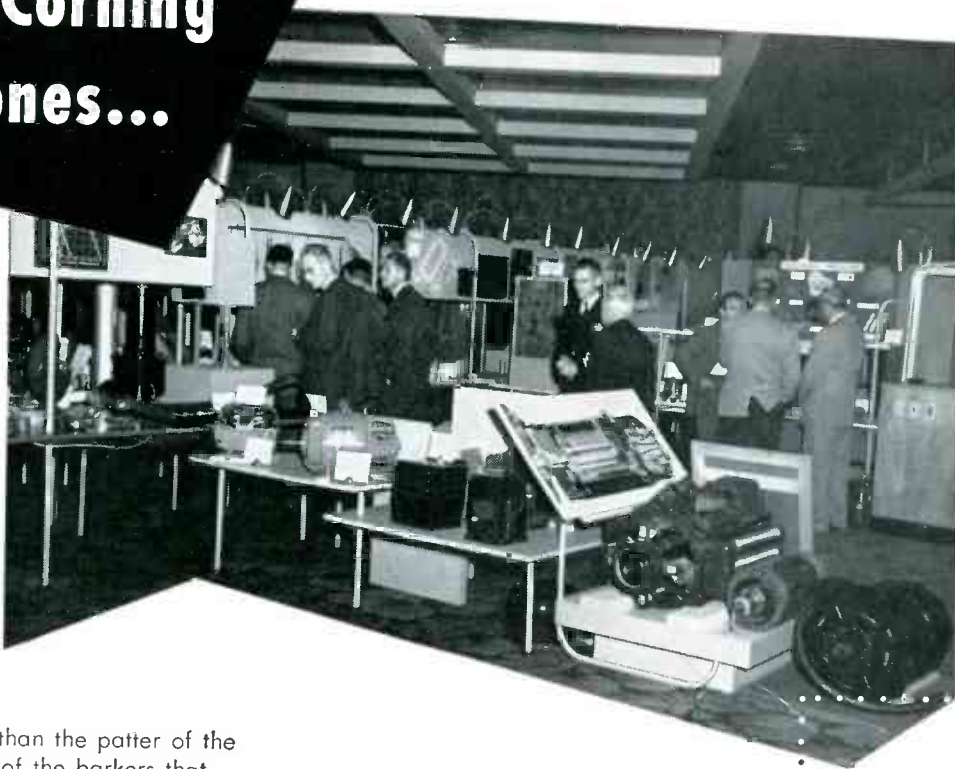

... is more fantastic than the patter of the pitchman or the spiel of the barkers that doubled in advertising and sales a generation ago. For example:

- Silicone (Class H) electrical insulation makes motors and other kinds of electrical equipment last 10 times as long as they ever did before.
- These same insulating materials are used to double the power per pound ratio in electric machines.
- Silastic,* the Dow Corning silicone rubber is used to seal hot air at 600°F., hot oil at 350-400°F., limit switches and bomb bay doors at -100°F.
- Dow Corning Silicone oils and greases make permanent lubrication a practical reality.

To many engineers and executives, such silicone facts as these still sound too good to be true. That's why we have built and assembled 16,000 pounds of demonstration units and typical applications to prove that our silicone products will do all that we claim for them. This is the first comprehensive Silicone Exposition ever assembled. Previewed in Washington, D. C. during the week of October 22nd, this exhibit will be given private showings in major industrial centers across the country.

DOW CORNING CORPORATION

ATLANTA
CHICAGO
CLEVELAND
DALLAS
LOS ANGELES
NEW YORK
WASHINGTON, D. C.

**DOW CORNING
SILICONES**

MIDLAND, MICHIGAN

In CANADA: Fibreglas Canada, Ltd., Toronto • In GREAT BRITAIN: Midland Silicones, Ltd., London

DOW CORNING SILICONE EXPOSITION

now scheduled for

CLEVELAND
DETROIT
PHILADELPHIA
NEW YORK
BOSTON
PITTSBURGH
CHICAGO
WICHITA
FORT WORTH
LOS ANGELES

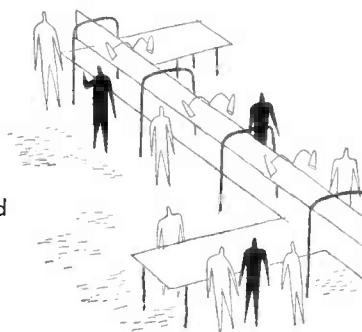

If you want to know more about this Exposition write for complete information including our new 32-page book which answers in simple words and pictures, the \$64 question, "What's a Silicone?" Address Department BE-14

DOW CORNING
CORPORATION
Midland, Michigan

*T.M. REG. U.S. PAT. OFF.

wilcox

Choice of the Airlines

Twenty-seven airlines in the United States and Hawaii have purchased Wilcox communications and navigation equipment. These purchases include everything from large ground station transmitters and receivers to complete air-borne multichannel communications systems. Some purchasers use Wilcox equipment exclusively. The Wilcox Company is both grateful and proud of this fine tribute to the performance, stamina, and dependability of its products.



WILCOX ELECTRIC COMPANY

14th and CHESTNUT

KANSAS CITY 1, MISSOURI, U.S.A.

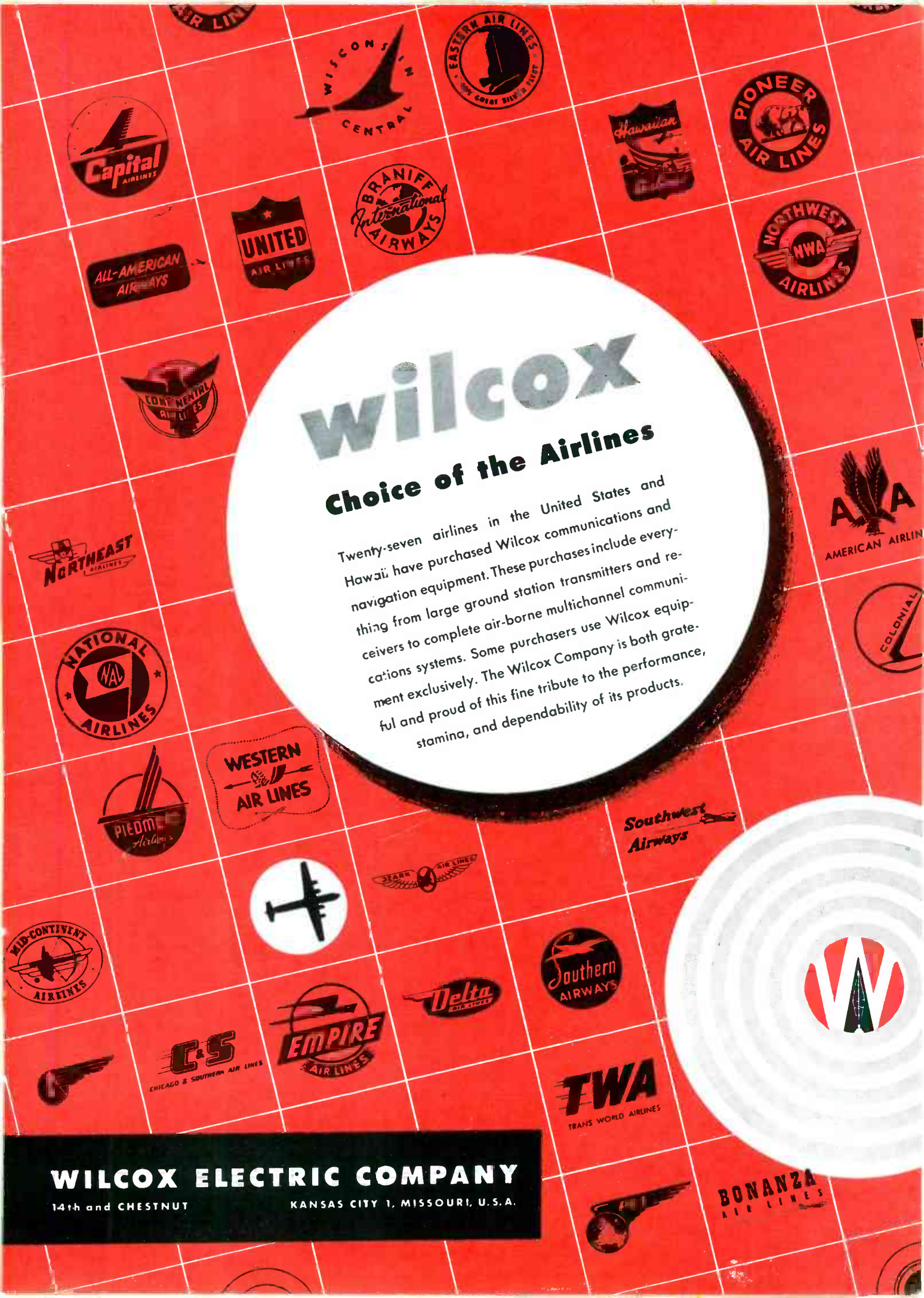

A general-purpose **DUAL**-beam oscillograph
to fit your needs technically and financially

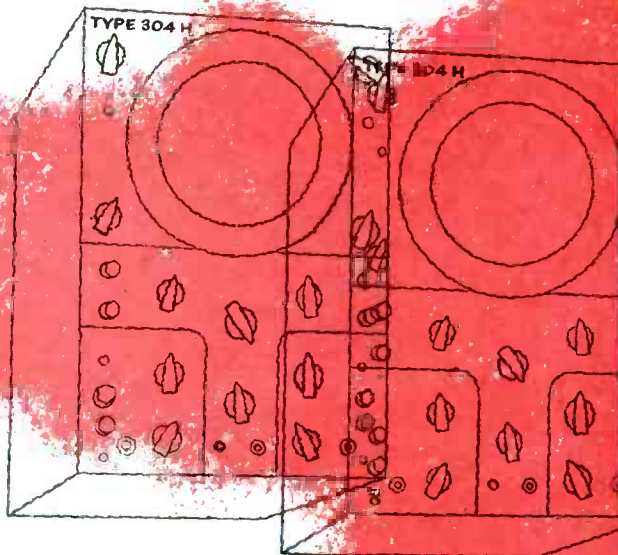

the **DU MONT**
TYPE 322

Not just another specialized dual-beam oscillograph, but a brand-new type designed for general development work but rugged enough for production testing and industrial applications as well. Compactness, lightweight, ruggedness and versatility mark the Du Mont Type 322 as another milestone in cathode-ray oscillography.

FEATURES All the well-known features of the 304-H, and...

- Thoroughly field-tested.
- Individual and common time bases with driven or recurrent sweeps and sweep expansion on all sweeps.
- Conventional single-ended input with stepped and vernier attenuators, or balanced input with no attenuation, on both Y-axes.
- Concentric controls for easy-to-operate, compact control panel.
- High-gain D-C amplifiers on both channels.
- Amplitude calibration on either channel on both axes.
- Illuminated scale with dimmer control.

SPECIFICATIONS

Cathode-ray Tube — Type 5SP — Dual-beam Cathode-ray Tube. Accelerating potential, 3000 volts.

Y-Deflection Sensitivity — 0.028 peak-to-peak (0.01 rms) volts/inch from D-C to 300 KC (50% down at 300 KC); A-C coupling, 10% down at 5 c.p.s.

X-Deflection Sensitivity — 0.3 peak-to-peak (0.1 rms) volts/inch from D-C to 300 KC (down 50% at 300 KC); A-C coupling down 10% at 5 c.p.s.; common, D-C to 200 KC (down 50% at 200 KC).

Linear Time Base — Recurrent and driven sweeps variable in frequency from 2 to 30,000 c.p.s. Front panel connections provided for lower frequency by adding external capacitance.

Intensity Modulation — Input impedance 0.2 megohm, paralleled by 80 μ f. Negative signal of 15 volts peak blanks beam at normal intensity settings.

Beam Control Switch — On front panel to turn beams on or off independently or simultaneously.

Calibrator — Regulated potentials of 50 millivolts and 1 volt peak-to-peak squarewave at power line frequency available at front panel binding posts.

Power Source — 115/230 volts — 50-400 c.p.s. — 225 watts.

Dimensions — Height 15 $\frac{3}{4}$ " , width 12 $\frac{1}{2}$ " , depth 22 $\frac{3}{8}$ " , weight 75 lbs.

\$835⁰⁰

Write for complete technical details:

Instrument Division
Allen B. Du Mont Laboratories, Inc.
1500 Main Avenue, Clifton, N. J.

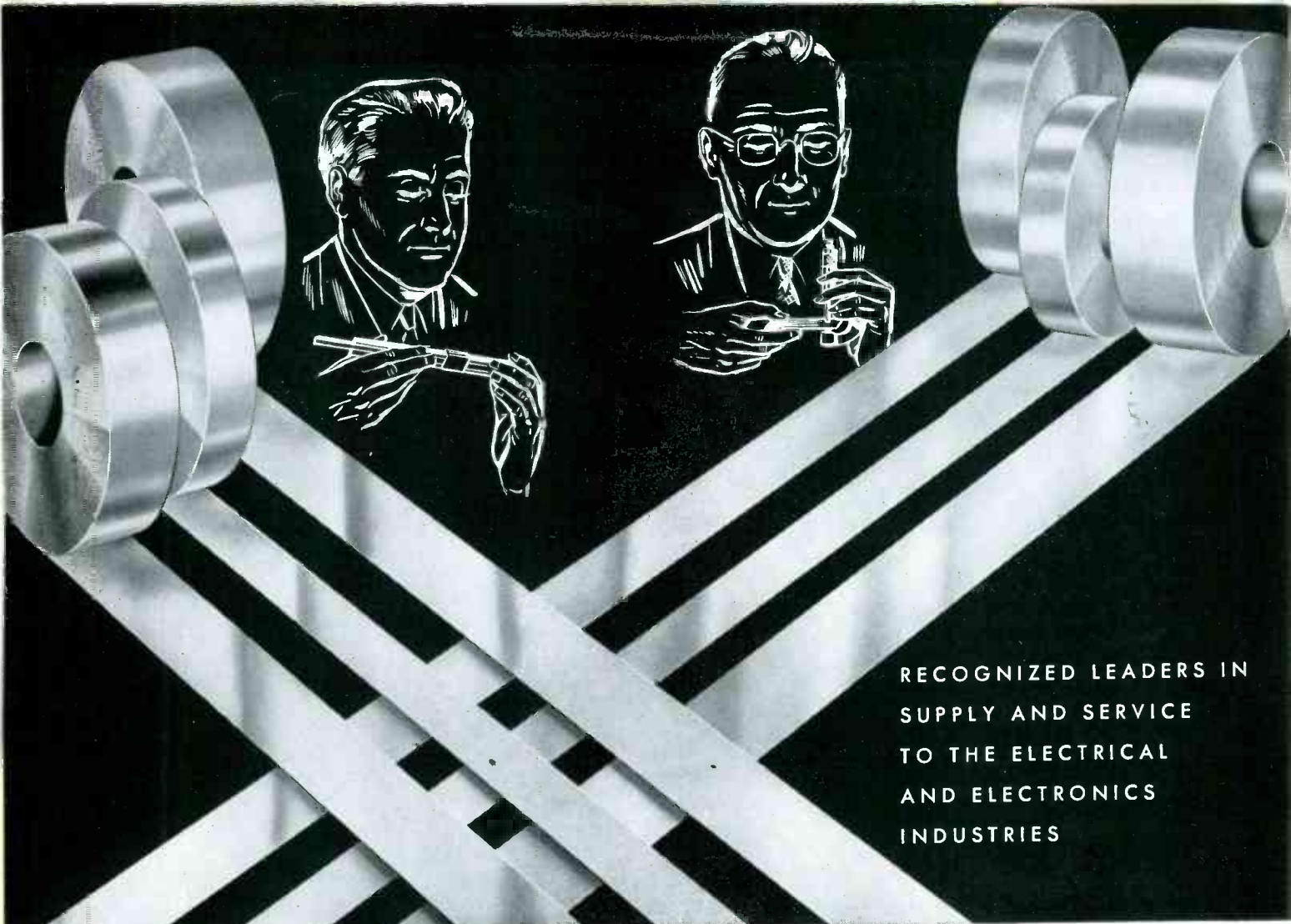

RECOGNIZED LEADERS IN
SUPPLY AND SERVICE
TO THE ELECTRICAL
AND ELECTRONICS
INDUSTRIES

RELY on REPUBLIC
FOR
ALUMINUM CONDENSER FOIL
OF UNIFORM HIGH QUALITY

Leading condenser manufacturers specify Republic aluminum condenser foil because, based on long experience, they recognize that the straight cut edges, accurate gage and uniform strength of Republic foil give maximum performance. As specialists in the production of condenser foil, Republic makes available its entire facilities for the solution of your individual problems. Your orders and inquiries will receive prompt and individual attention.

REPUBLIC FOIL & METAL MILLS
INCORPORATED
DANBURY **CONNECTICUT**

BRANCH SALES OFFICES: 209 W. Jackson Blvd., Chicago 6, Ill.
666 Mission St., San Francisco 5, Calif.

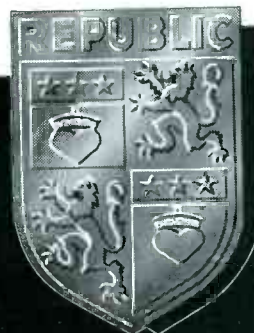

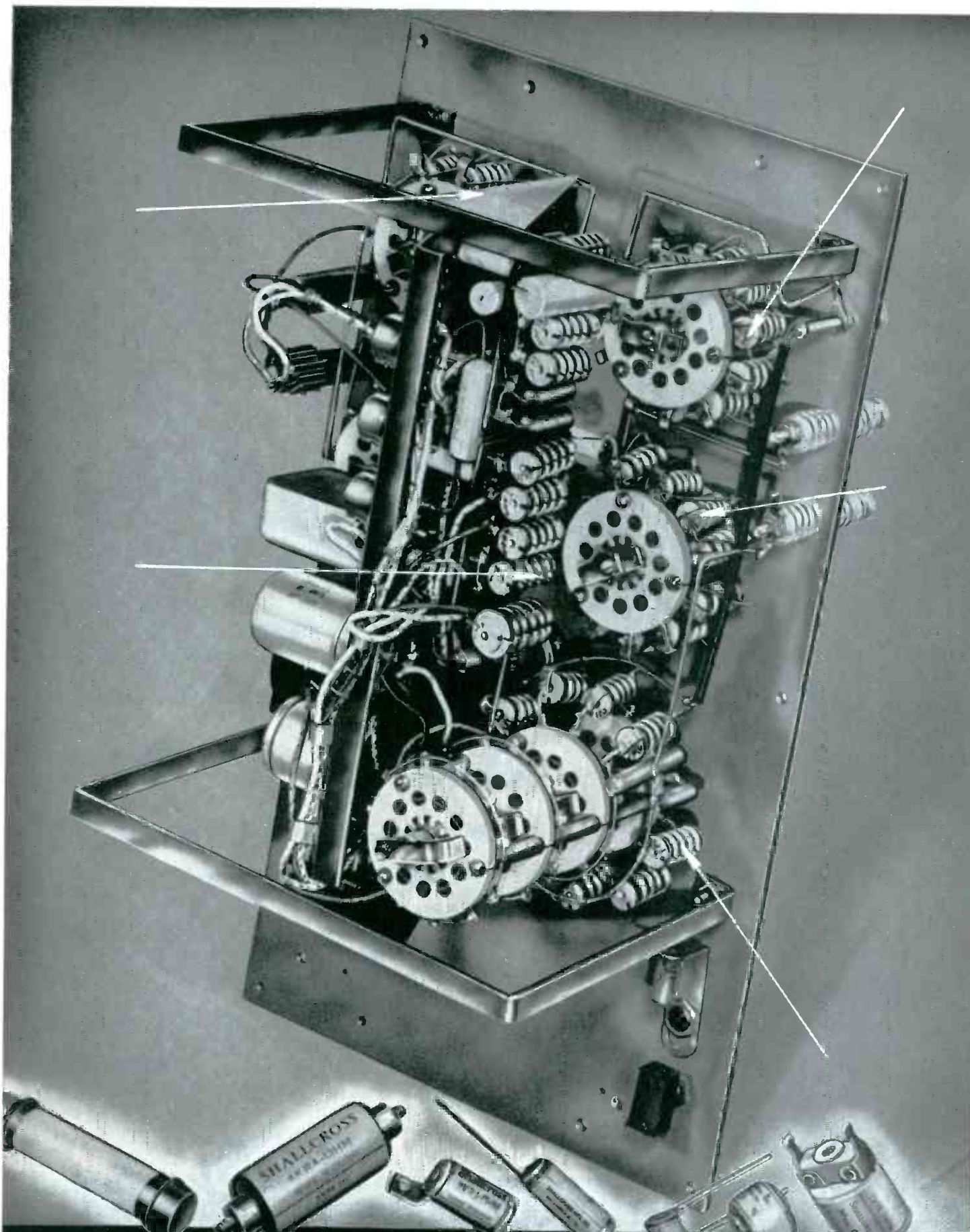

THE *Complete* PRECISION RESISTOR LINE

Maybe you've noticed
how much of today's
best equipment

uses

SHALLCROSS

precision

WIRE-WOUND RESISTORS

Accuracy from $\pm 1.0\%$ to 0.01% as required

JAN R-93 types ("A" and "B" characteristics)

High-stability types

(Tolerance 0.01% ; stability 0.003%)

Matched pairs and sets

Hermetically-sealed types

Low-temperature coefficient types

Predetermined time constant types

Precision power types

Miniature types

Hermetically-sealed lug-type midgets

Vertical style types

Multi-unit strip resistors

Potted types

Precision card resistors

... and many special types

SHALLCROSS MANUFACTURING COMPANY
Collingdale, Pa.

See Us
at the
I.R.E. Show
Booths 280-281



FOR MILITARY AND INDUSTRIAL USES

Bradley

development and low cost production of precision rectifiers

Even while expanding, we have retained the basic operating characteristics of a production laboratory. Our manufacturing operations are laboratory methods placed on a volume production basis.

This means that your regular rectifier requirements are not simply manufactured. They are lab-controlled. You can depend on Bradley rectifiers to perform according to specifications, not just in a majority of cases but in all cases.

And being a production laboratory, we have the ideal facilities for handling special rectifier problems. If we make your rectifier in our laboratory, you can count on a production component that will duplicate performance in every respect. Just as important, you can be sure of the lowest possible unit cost for a rectifier of this type.

SELENIUM AND COPPER
OXIDE RECTIFIERS

SELF-GENERATING
PHOTOELECTRIC CELLS

VACUUM-PROCESSED for PERFORMANCE AS RATED

BRADLEY LABORATORIES, INC.
168 COLUMBUS AVENUE • NEW HAVEN 11, CONNECTICUT

SELENIUM RECTIFIER SR 114
USED AS PRECISION LIMITER



This hermetically sealed rectifier was developed to restrict current flow within critical specified limits. It typifies the laboratory type job that Bradley can produce on a production basis. Tests for this rectifier are critical to a hundredth of a volt, and many principal values are fractions of a volt.

MICROWAVE POWER MEASUREMENTS

COMPLETE COVERAGE! 10 to 12,400 mc!

Instantaneous, direct readings! No adjustment during operation! No tedious computations! Complete new instrumentation for fundamental measurements of CW or pulsed power!



New! **-hp- 430B Microwave Power Meter—measures pulsed or CW power— .02 to 10 mw**

Model 430B gives you *instantaneous* rf power readings *direct* in db or mw at any frequency. (Operates with bolometer mount. Table at left shows *-hp-* mounts now available.) Measures CW power with instrument fuse or barretter as bolometer element; also measures CW or pulsed power using negative temperature coefficient thermistor at 100 or 200 ohm levels. Reads power direct .02 to 10 mw or in dbm from -20 to +10. 5 ranges selected on front panel switch. Accuracy $\pm 5\%$ of full scale. Higher powers may be measured by adding attenuators (*-hp-* Models 370, 380) to rf system. Directional couplers may be used to sample rf energy.

Instrument	Frequencies— Coaxial	Frequencies— Waveguide	Price (f. o. b. Factory)
475B Tunable Bolometer Mount	1,000 to 4,000 mc		\$200.00
476A Untuned Bolometer Mount	10 to 1,000 mc		\$125.00
5485A Detector Mount*		2,600 to 3,950 mc	\$125.00
G485B Detector Mount †		3,950 to 5,850 mc	\$95.00
J485B Detector Mount †		5,850 to 8,200 mc	\$90.00
H485B Detector Mount †		7,050 to 10,000 mc	\$85.00
X485B Detector Mount †		8,200 to 12,400 mc	\$75.00
430B Microwave Power Meter	For use at any microwave frequency. Operates with mounts listed above.		\$250.00
*For use with bolometer only.		†For use with bolometer or crystal.	



-hp- 485 Detector Mounts

For rf power measurements in waveguide systems, 2,600 to 12,400 mc (see table) in conjunction with *-hp-* 430A or 430B Power Meter and Sperry 821 barretter. Also may be used to measure relative level, or detect rf energy using a type 1N21 crystal. Semi-tuned by means of a built-in movable short.



-hp- 475B Bolometer Mount

Tunable from 1,000 to 4,000 mc for universal application, greatest convenience in making microwave power measurements. Double-stub design, coupling energy from 50 ohm coaxial systems into 100 or 200 ohm bolometers. Uses Sperry 821 barretter, thermistor or 1/100 ampere instrument fuse.

New!

-hp- 476A Universal Bolometer Mount



Requires no tuning, no adjustment; measures rf power at any frequency 10 to 1,000 mc. Extremely low VSWR: Less than 1.15, 20 to 500 mc; less than 1.25, 10 to 1,000 mc. Reflected power less than 0.1 db under normal conditions. In combination with *-hp-* 430A or

430B Power Meter gives automatic, instantaneous readings from 0.02 to 10 milliwatts. Measures higher power with addition of attenuators and directional couplers. 50 ohms impedance. Has Type N connector and terminates flexible cables RG8/U, RG10/U, etc.

Get complete information! See your local *-hp-* representative or write to factory.

HEWLETT-PACKARD COMPANY

2161-A PAGE MILL ROAD • PALO ALTO, CALIFORNIA, U.S.A.
Export: Frazar & Hansen, Ltd., San Francisco, New York, Los Angeles

HEWLETT-PACKARD  INSTRUMENTS



Simplify electrical studies with these Brush instruments



Brush Deviation Test Bridge

SPEEDS UP INSPECTION. Resistors, capacitors and inductors are rapidly and accurately inspected by this Brush Deviation Test Bridge. Indicates percentage of deviation of a test component from the standard. Has large, easy-reading dial. Very high indicating speed permits testing at rates as high as 4,000 elements per hour. Free bulletin on request.

RECORDS TWO PHENOMENA SIMULTANEOUSLY. This team of Brush Dual Channel Amplifier and Magnetic Oscillograph are here being used to record generator voltage and field current time-curves. This simplifies plotting of saturation curve to study build-up of voltage. Requires only a few minutes . . . compared to hours for conventional plotting methods. Investigate these Brush instruments for the study of many other electrical variables. Write for bulletin.



REGULATES FREQUENCY. The Brush Regulated Frequency Power Supply furnishes moderate power at 60 cycles that is completely unaffected by the frequency of the primary power source. It will govern the operation of fractional horsepower synchronous motors at fixed speed or set the characteristics of controls where accurate frequency is essential. No adjustments are needed for any loading from zero to full capacity of 60 watts. Rugged construction permits use in field. Frequency accuracy is one part in 100,000. Write for complete information and specifications.



Brush Model BL-809
Regulated Frequency Power Supply

FOR PHYSICAL VARIABLES. The Brush "Universal Analyzer" gives instantaneous, accurate recording of a wide variety of physical variables such as strain, pressure, acceleration, torque, force, temperature, displacement and vibration. This new Brush Analyzer, consisting of a Carrier Type Bridge Amplifier and Direct-Inking Oscillograph, is a complete unit. You simply connect it to your standard pickup elements. With proper calibration resistors, its ink-on-paper records can be interpreted immediately and easily in any desired units of physical measurement. Write today for complete details.

Brush "Universal" Strain Analyzer



Write Dept. K-19 for free copy of Bulletin 618 giving details on these Brush instruments.

PUT IT IN WRITING WITH A BRUSH RECORDING ANALYZER

THE *Brush* DEVELOPMENT CO.

PIEZOELECTRIC CRYSTALS AND CERAMICS • MAGNETIC RECORDING
ELECTROACOUSTICS • ULTRASONICS • INDUSTRIAL & RESEARCH INSTRUMENTS

WALDES TRUARC RINGS REPLACE COTTER PINS... SAVE 44% IN LABOR AND ASSEMBLY COSTS

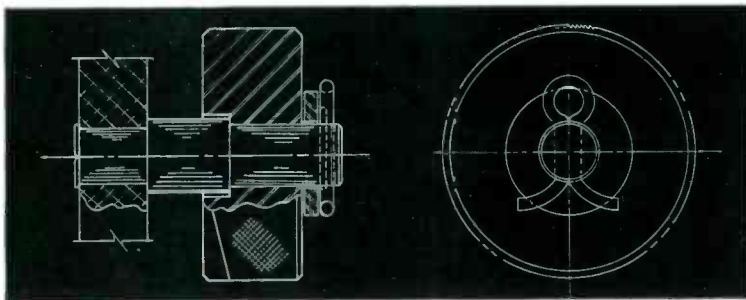

COTTER PIN WAY: Flint wheel shaft in lighter assembly requires cotter pin, washer. Difficulty in drilling perfect hole causes rejects. Assembly is slow, costly.

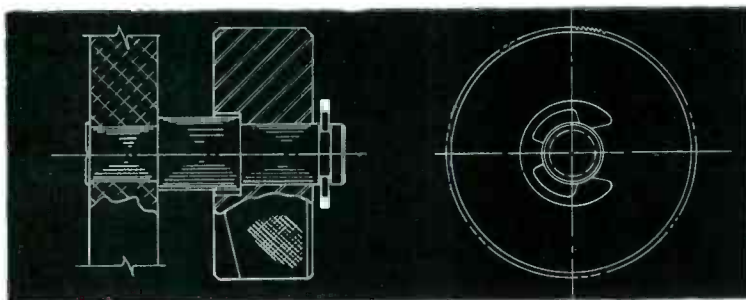

TRUARC WAY: Waldes Truarc "E" ring fits into groove in shaft; locks assembly securely for life. Groove is quickly, easily cut... assembly is simple, speedy.



Brown & Bigelow, St. Paul, Minn., saved \$6.95 per thousand units by incorporating Truarc Rings in the design for the REDI-FLAME compressed gas desk lighter! In spite of greater initial cost of Truarc Rings as against cotter pins, they were able to cut machining and assembly costs drastically—for an overall savings of 44%!

Redesign with Waldes Truarc Rings and you too will cut costs. Wherever you have a fastening problem... where

ever you use machined shoulders, bolts, snap rings, cotter pins, there's a Truarc Ring designed to do a better job of holding parts together.

Waldes Truarc Rings are precision-engineered... quick and easy to assemble and disassemble. They can be used over and over again.

Find out what Truarc Rings can do for you. Send your blueprints to Waldes Truarc engineers for individual attention, without obligation.

COMPARATIVE COSTS

Cotter Pin Way		Truarc Way	
Material	\$ Per M	Material	\$ Per M
Shaft	.48	Shaft	.35
Cotter pin	.46	Truarc ring	8.68
Washer	1.50		
	2.44		9.03
Labor		Labor	
Shaft	10.22	Shaft	2.27
Washer	.72		
Assembly	9.28	Assembly	4.41
	20.22		6.68
TOTAL	\$22.66	TOTAL	\$15.71
TOTAL SAVINGS WITH TRUARC RINGS:			
\$6.95 or 44%			

For precision internal grooving and undercutting... Waldes Grooving Tool.

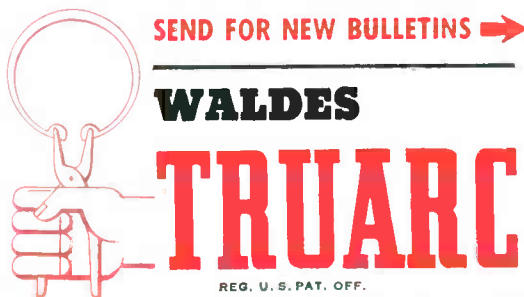

RETAINING RINGS

WALDES KOHINOOR, INC., LONG ISLAND CITY 1, NEW YORK

WALDES TRUARC RETAINING RINGS AND PLIERS ARE PROTECTED BY ONE OR MORE OF THE FOLLOWING U.S. PATENTS: 2,382,847; 2,382,948; 2,416,852; 2,420,921; 2,428,341; 2,439,785; 2,441,848; 2,455,185; 2,483,380; 2,483,383; 2,487,802; 2,487,803; 2,491,306; 2,509,081 AND OTHER PATENTS PENDING.



Waldes Kohinoor, Inc., 47-16 Austel Place, L. I. C. 1, N. Y. Please send engineering specifications and data on Waldes Truarc Retaining Ring types checked below. E024

- Bulletin #5 Self-locking ring types
- Bulletin #6 Ring types for taking up end-play
- Bulletin #7 Ring types for radial assembly
- Bulletin #8 Basic type rings
- Send me information about the Waldes Grooving Tool.

Name _____

Title _____

Company _____

Business Address _____

City _____ Zone _____ State _____ 5678



Harry M. Neben, Chief, Electrical
AMPHENOL Testing Laboratory



RECOMMENDS
Simpson Model 303
VACUUM TUBE VOLT-OHMMETER

Says Harry M. Neben: "I understand the 303 was developed to be of particular use to television service men for aligning sets in the field—so it's designed to perform a lot of test functions and is compact and easy to carry around. These same features make it quite a valuable laboratory and production tool here at Amphenol."

In the photo, Mr. Neben is using the Simpson 303 in conjunction with an Amphenol test fixture to measure insulation resistance between one wire and all other wires of a cable assembly.

SPECIFICATIONS

DC VOLTAGE: Ranges 1.2, 12, 60, 300, 1200 (30,000 with Accessory High Voltage Probe).
 Input Resistance 10 megohms for all ranges.
 DC Probe with one megohm isolating resistor.
 Polarity reversing switch.
OHMS: Ranges 1000 (10 ohms center), 100,000 (1000 ohms center), 1 megohm (10,000 ohms center), 10 megohms (100,000 ohms center), 1000 megohms (10 megohms center).
AC VOLTAGE: Ranges 1.2, 12, 60, 300, 1200. Impedance (with cable) approx. 200 mmf. shunted by 275,000 ohms.
AF VOLTAGE: Ranges 1.2, 12, 60. Frequency Response Flat 25 to 100,000 cycles.
DECIBELS: Ranges -20 to +3, -10 to +23, +4 to +37, +18 to +51, +30 to +63.
 Zero Power Level 1 M. W., 600 ohms.

GALVANOMETER: Zero center for FM discriminator alignment and other galvanometer applications.
R. F. VOLTAGE: (Signal tracing with Accessory High Frequency Crystal Probe). Range 20 volts maximum. Frequency Flat 20 KC to 100 M.C.
LINE VOLTAGE: 105-125 V. 50-60 Cycles.
SIZE: 5 1/4" x 7" x 3 1/4" (bakelite case). Weight: 4 lbs. Shipping Wt.: 6 1/2 lbs.
STILL AT THE SAME NET PRICE: Model 303, including DCV Probe, ACV—Ohms probe and Ground Lead with Operator's Manual—\$58.75.
 Accessory High Frequency Probe, \$7.50
 Accessory High Voltage Probe, \$9.95
 Also available with roll top case, Model 303RT—\$66.70

Available through your Parts Jobbers

Simpson ELECTRIC COMPANY

5200 W. Kinzie St., Chicago 42, Illinois Phone: COLUMBUS 1-1221
 In Canada: Bach-Simpson, Ltd., London, Ont.

World's Largest Makers of Electronic Test Equipment

BURTON BROWNE ADVERTISING



CLECO
A-1 PNEUMATIC
REVERSIBLE
SCREW DRIVERS



Photograph Courtesy General Radio Company, Cambridge, Mass.

**This little tool is
doing a great big job!**

New CLECO
9-RSPC
Reversible Pneumatic Screw Driver
Larger and more powerful than the Cleco A-1. This light weight production tool is used for screw-driving and nut running on many production jobs.
Capacity 1/4" machine screws or No. 14 wood screws.
Write for bulletin P-851.

So small it is almost hidden by the man's hand, this Cleco A-1 pneumatic screw driver is increasing production of potentiometers by running No. 8 nuts *fast!*

Ideal for similar small work, the A-1 is much easier to handle than larger tools. Operator fatigue is reduced and as a result, production is increased even further.

In spite of its small size and light weight, the Cleco A-1 is a rugged production tool built for years of service. Write for bulletin S-750 or, better yet, ask us for a demonstration in your own plant.



CLECO DIVISION



of the REED ROLLER BIT COMPANY, 5125 Clinton Drive, Houston 20, Texas, U.S.A.

DIVISION OFFICES

- GEORGIA: Atlanta 3, 502 Peters Bldg. • ILLINOIS: Chicago, 5701 West Madison St. • MASSACHUSETTS: Worcester, 23 Enfield St.
- MICHIGAN: Detroit, 2832 East Grand Blvd. • MISSOURI: St. Louis 3, 2322 Locust St. • NEW JERSEY: Newark 4, 75 Lock St.
- OHIO: Cincinnati 2, 729 Temple Bar Bldg. • PENNSYLVANIA: Philadelphia 20, 5220 North Fifth St. . . . Pittsburgh 17, 5626 Phillips Ave.
- TEXAS: Fort Worth, 1717 East Presidio • CALIFORNIA: Los Angeles, 1317 Esperanza St. • MARYLAND: Baltimore 20, 39D Oak Grove Dr.

In Canada: Cleco Pneumatic Tool Company of Canada, Ltd., 927 Millwood Road, Toronto (Leaside), Ontario
DISTRIBUTORS IN PRINCIPAL CITIES OF THE UNITED STATES AND THROUGHOUT THE WORLD

3223

TIME DELAY RELAYS



CLOCK MOVEMENTS

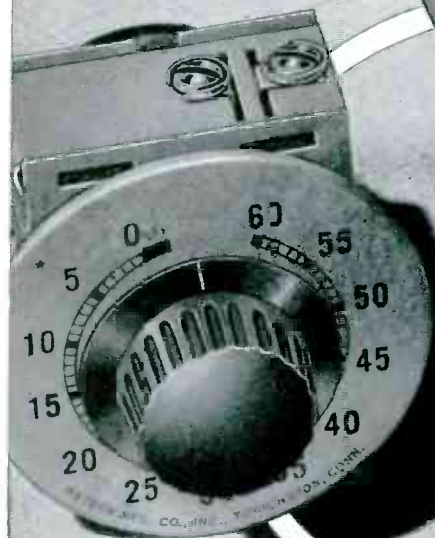
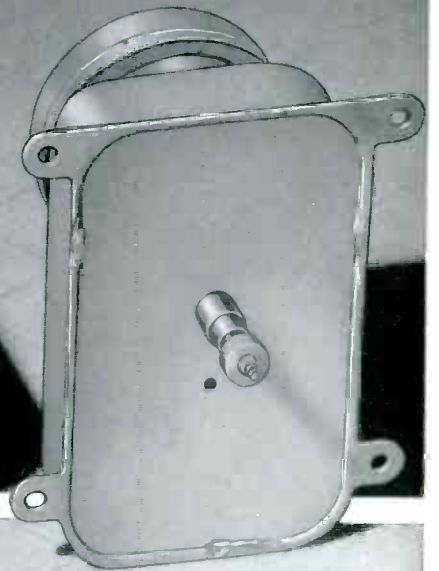

INTERVAL TIMERS

HAYDON

AT TORRINGTON

HEADQUARTERS FOR

TIMING

ELAPSED TIME INDICATORS

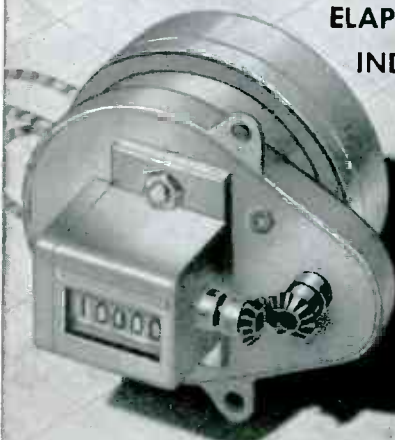

TIMING MOTORS



TIMING MOTORS

HAYDON* timing motors offer many advantages. Slow rotor speed allows minimum of gearing for various output shaft speeds providing quiet operation and long life. Unusually small size. Motors totally enclosed. Controlled lubrication with separate rotor and gearing lubricating systems permits selection of best method and lubricants. Operates continuously in any position. Simple to mount securely. Interchangeable design in only 2 motor series with standard speed range from 60 rpm to one revolution in 7 days. Write for Motor Catalog.



400 CYCLE MOTORS and TIMERS FOR MILITARY APPLICATIONS

HAYDON research and engineering staffs constantly seek to develop new and build better products. One example is the HAYDON 400 cycle timing motor. This is an hysteresis type synchronous timing motor, for use as a separate motor or in many different types of timers. HAYDON personnel and plant are equipped to build motors and timers using D.C., 60 cycle or 400 cycle for military or civilian applications. Write for Engineering Bulletin No. 2 for complete information on the 400 cycle motor.



TIMING DEVICES

HAYDON specializes in the manufacture of timing components for standard applications and also in the design and mass production of custom-engineered timers for volume applications. The basic element of all HAYDON timers is our own rugged industrial motor described above. This means that HAYDON timing devices can be depended upon to give long, quiet operation. They are small and compact and offer designers unusual latitude in that they may be mounted and will operate without interruption in any position. Write for Device Catalog.



HAYDON Manufacturing Co., Inc.

SUBSIDIARY OF GENERAL TIME CORPORATION

2426 ELM STREET, TORRINGTON, CONNECTICUT

When electrical noise suppression is a problem . . .
 put MALLORY'S specialized skills to work for you

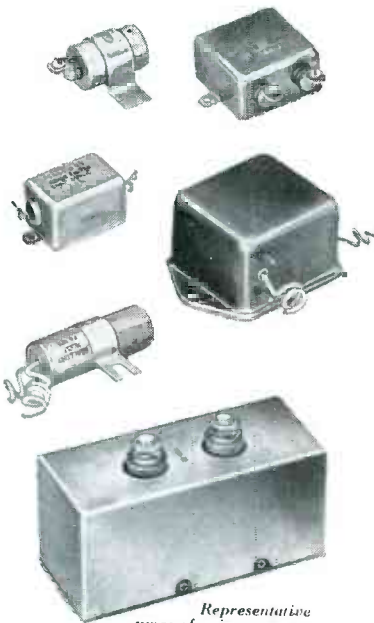
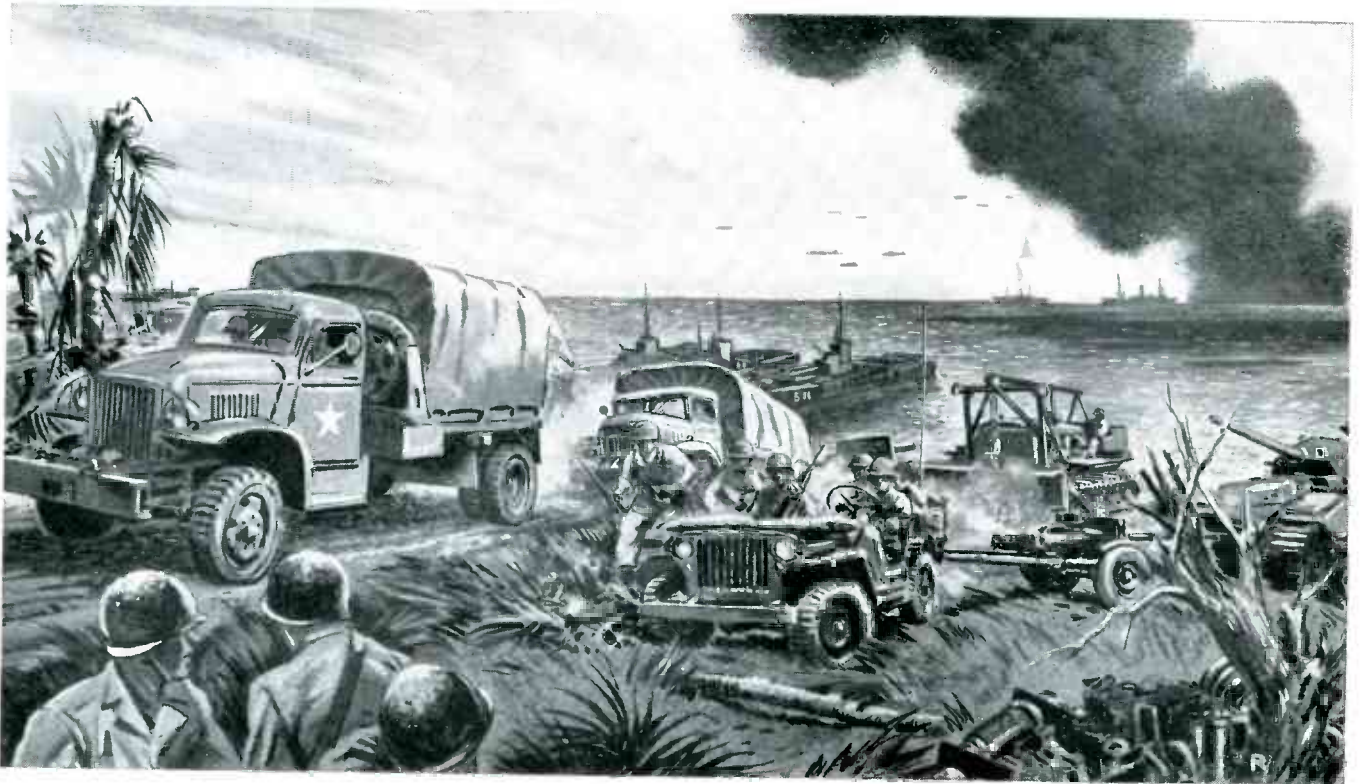

Representative types of noise suppression filters and capacitors.

You can turn to Mallory with complete confidence when you need help in meeting the rigid electrical noise suppression requirements for military equipment.

Mallory personnel, facilities and experience which helped many manufacturers beat this problem during World War II are at your service today . . . ready with the filters and capacitors . . . ready, too, with application "know-how" essential to satisfactory noise suppression in your equipment.

And since the war, Mallory has worked steadily on noise suppression problems created by the ever-increasing use of electronic equipment by our Armed Forces.

Put Mallory's specialized skills and experience to work for you whenever you need standard filters and capacitors to meet Signal Corps and Ordnance specifications . . . or when you need special types for unusual uses. Call or write Mallory today.

P. R. MALLORY & CO., Inc.
MALLORY

SERVING INDUSTRY WITH

Electromechanical Products—Resistors • Switches • TV Tuners • Vibrators
 Electrochemical Products—Capacitors • Rectifiers • Mercury Dry Batteries
 Metallurgical Products—Contacts • Special Metals • Welding Materials

P. R. MALLORY & CO., INC., INDIANAPOLIS 6, INDIANA



CROSS TALK

► **REPORT** . . . Beginning on page 4 of this issue, **ELECTRONICS** inaugurates a new service to its readers under the title "INDUSTRY REPORT".

The purpose of **INDUSTRY REPORT** is to inform our readers of significant trends in the industry, with particular emphasis on the "business end" of electronics. The style of reporting is brief, the language nontechnical; the subjects range over the whole field of electronics—industrial, business, government and commercial activity. Technical topics will be treated (in this issue, an interpretative piece on germanium, for example) but always in nontechnical language. We plan to do a bang-up job on industry statistics and have formulated a monthly index of business activity, geared to physical production which, we hope and predict, will be followed with interest by all readers of this magazine.

The philosophy behind the new service is simply stated. The industry of electronics has grown enormously since prewar years. Factory value of products has increased from \$250 million in 1941 to nearly \$4 billion in 1951. The core of this great production of wealth is the technical man, the reader of **ELECTRONICS**, if you will, who has the specialized vocabulary to read the technical material we publish. But superimposed on this technical core, is a very sizeable second group of individuals, some with

business training but without formal technical background, others with engineering training, whose management responsibilities prevent their keeping up with technical details. **INDUSTRY REPORT** is geared for *both* groups. We hope it fills the bill, and we urgently solicit your comment and criticism.

This is an addition to our established editorial content. Nothing has been removed, in quantity or quality, from the editorial section which begins, as usual, on this page.

► **DEPARTMENTS** . . . Readers will note changes in the "back of the book" in this issue. Two departments have been combined, a new department started and a new style of departmental makeup adopted. Since 1935, our readers have grown to know *Tubes at Work* and *The Electron Art*. The distinction between these departments has become increasingly diffuse, so we have decided to combine them under the title *Electrons at Work*. This, incidentally, admits the transistor and its cousins to the Tubes At Work category and sidesteps the question of what is a transistor. Ron Jurgen will edit E at W.

The new department, *Production Techniques* is a departure to a field not heretofore covered every month. Its purpose is fully described on page 220. Comments, criticisms and contributions for

PT should be sent directly to John Markus, who edits the new pages.

The makeup change will, if our mail is any indication, be greeted with shouts of joy. Effective this issue, each department now runs in consecutive pages and columns to its end before the next starts. This will avoid skipping through the back of the book, following page numbers: it will also cause certain departments to appear in unaccustomed positions. If you don't find your old friends in the regular place, consult the table of contents, page 1.

► **RELIABLE** . . . **JETEC** is currently engaged in a commendable effort to improve the reliability of electronic equipment through improved design of electron tubes and better understanding of their ratings. We will shortly print material germane to this program. Meanwhile we observe that this subject should not go under the name merely of "tube reliability". Circuit reliability is equally important. Tubes and circuits are so indivisibly related that it is impossible to achieve reliable operation without equal attention to both phases. Nor should **JETEC** feel shy about tramping on the toes of the circuit men outside its sphere of influence. This is—must be—a "tube and circuit reliability" program. And it's everybody's business.

Electronics Engineering

Medical progress depends to a great extent on progress in electronic devices that enable the research worker and clinician to measure and control physiological phenomena.

Past, present and future jobs for electronics are discussed

MEDICINE, as it has been practiced through the years, cannot be considered a science. It would be more aptly termed a pseudo-science.

The present state of the practice of medicine results from the accumulation of some facts and a generous proportion of fancy. The doctor who practices successfully must still lean heavily on the art of medicine. On the other hand, the doctor who devotes his time to research must stick more closely to elaborations of the so-called "known facts and concepts." However, knowledge of many of these "facts" has been gleaned only through a pseudo-scientific approach.

Available Tools

In the clinical practice of medicine, there are two basic units on which to a large measure, our diagnoses and treatments are based. The first is the reactions of the patient in describing the history of his illness. The second is the reaction of the doctor to his findings. For most illnesses there are no mathematic-like responses on which we can rely to achieve a more scientific background for our diagnoses.

An interesting exception to this may be given in the development of the electrocardiograph. Prior to the time that this instrument was in general use, it was rather difficult to distinguish between a major and a minor heart attack.

With the introduction of the electrocardiograph, physicians were presented with a truly impersonal means of assistance. They were able to render a more accurate diagnosis, and to estimate better the prognosis of the disease.

Unfortunately there are too few examples such as this that may be cited. The x-ray, the electroen-

cephalograph, the chemical tests, the photoelectric calculators and possibly a few others have been most helpful in minimizing the personal reaction. For the most part, the contributions which medicine requires for its advance, are still forthcoming.

Roentgenology

In the field of roentgenology, a number of important contributions are needed. Our current apparatus produces excellent visualization of bony structures. More recently we have been able to diagnose soft-tissue disturbances by using different techniques of exposure. By soft tissues we mean any of the body structures other than bone.

The tissue differential might be made so great that even minor degrees in density of structures might cause them to record differently. It is not inconceivable that even the color of internal organs may some day be recorded and used as an indication of the presence of pathologic change.

There is a tremendous need for

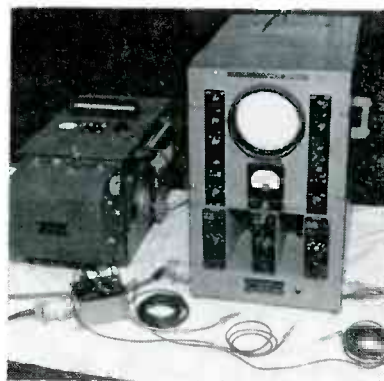

Accurate blood pressure measurements are simplified by use of electronic setup developed by University of Kansas Medical Center and the Hathaway Instrument Company. Twelve-channel recorder permits simultaneous study of pressures at various parts of the body

the miniaturization of x-ray equipment. Almost everyone has been subjected at some time to an x-ray at the doctor's office. I feel sure that the large, cumbersome equipment must represent an eyesore to those engineers who are interested in a miniaturization program. A huge structure is not necessarily more efficient. Newer, smaller and better equipment must eventually be provided.

It would be unwise to leave this field without some thoughts on the need for additional and more varied radioactive materials. Cancer may have several causes, and there is no proof that different cancers stem from a single disease. Therefore, its solution will probably not depend on a single element. However, the wedge for medical-engineering cooperative work is progressing in a remarkable manner with newer radioactive materials.

Recently, for example, radioactive cobalt has been introduced. It is now being studied in the treatment of cancer of the uterus. Other drugs are eliminated by the body in a specific, known manner; through the skin, the kidneys or the intestinal tract. Their combination with radioactive elements may prove valuable. It would seem that we are on the verge of making interesting discoveries along this line.

Anesthesia

Some words should be expressed regarding our expectations in the field of anesthesia. At this time, to perform an operation it is necessary to render the patient unconscious with a general anesthetic or to inject a drug locally or regionally in order to establish insensibility of a specific part. General anesthesia has some obvious disadvantages. Although local anes-

Needed in MEDICINE

By HERMAN I. KANTOR

*Assistant Professor of Obstetrics and Gynecology
Southwestern Medical Branch
University of Texas
Dallas, Texas*

thetia is quite safe, it also presents a number of drawbacks.

We still have hopes that perhaps our imaginative engineering friends will be able to develop an apparatus to produce a temporary form of nerve paralysis.

Measuring Pain

Pain is the cerebral recognition of noxious stimulation in a distal part. There are definite known pathways along which these stimuli travel. Moreover, when these pathways are blocked chemically, as with novocaine, the stimuli are no longer conveyed for cerebral response. This is the mechanism of local and regional anesthesia. It would not appear impossible that we may learn to block these same pathways electrically. With removal of the block, a normal intact nerve trunk would be left to function in its usual manner. This would truly offer the means to safe anesthesia.

There is a tremendous difference between individuals in their evaluation of the symptom of pain. One patient with a minor headache will present it as a major catastrophe. Another may minimize to unimportance the presenting symptom of a serious disease. It would seem that an apparatus for determining the degree of pain would prove most valuable to us.

Fertility

Our efforts to overcome human infertility are in urgent need of assistance. For example, it is thought that the ovaries of normal women produce a single egg in each menstrual cycle. However, we lack scientific methods of proving, first, that the egg is actually produced and, second, when in the cycle it is produced. Most of our current

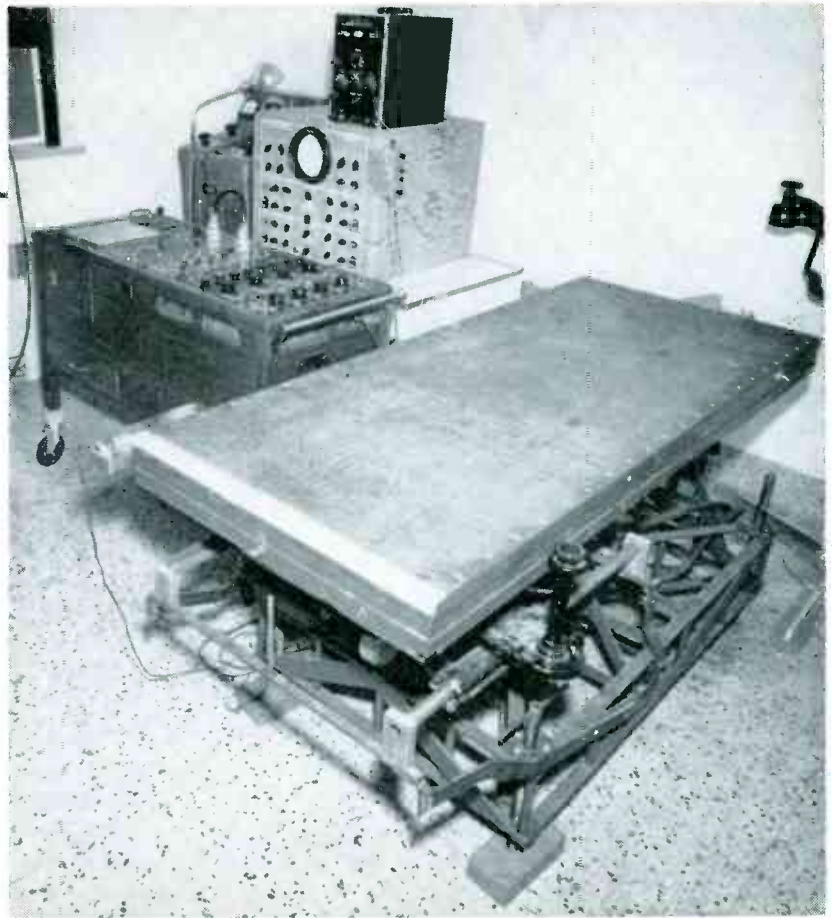

Extreme versatility of electronics in medicine is illustrated by the University of Kansas Medical Center ballistocardiograph table that records motion imparted to the body by the blood velocity change with each heart beat

means for these deductions are indirect and perhaps often inaccurate. An electrical apparatus has been made to help in this problem, but the results have been questioned by many investigators. It is thought that a change in potential does occur at the time of ovulation. Undoubtedly a better recorder can be made for this purpose.

We need assistance in the better evaluation of the fertility of semen specimens, and in the treatment of some of the deficiencies found.

Future Possibilities

In the foregoing discussion, the surface of the current needs of medicine has only been scratched. All branches will have their own requirements, and the potential cooperative ventures are enormous. The ophthalmologist, the laryngolo-

gist, the dermatologist—they all have problems to present; the engineers must find solutions.

Whenever a physician must depend on his senses or his judgement to measure a response, an electronic replacement is probably needed. A permanent committee in our universities to supervise medical-engineering cooperative ventures would have an almost endless task.

A more daring individual than the writer might perhaps even predict a change in future conversations. When friends meet, the prosaic "How do you feel?" may become obsolete. Perhaps it may be replaced by the question "How is your electronic recording today?"

The need for a more functional and more scientific approach by medicine to its practical problems is truly great.

New Pennsylvania Turnpike



Valley Forge interchange, eastern terminus of the Pennsylvania Turnpike, is also eastern end of microwave system, as indicated by one-way set of parabolas in upper left-hand corner of photograph

PROBLEMS in proper radio coverage have always been presented by the Pennsylvania Turnpike because of the mountainous terrain through which most of it passes. There is also the necessity to keep all sections advised of constantly-changing conditions of weather, roadway, and the thousands of other problems generated in the administration of such a vast roadway system.

Complete Circuit

A microwave circuit as a through circuit with a vhf system in conjunction with it for broadcasting to mobile units and intermediate fixed stations has proved to be an excellent solution to a difficult problem. In addition, a radio-teletype circuit for handling routine matters and a second voice circuit for administration communications, form a complete comprehensive com-

munication system stretching from Valley Forge to Pittsburgh and rapidly expanding with the roadway itself to the Ohio border.

The east circuit, which starts at the present eastern terminal at Valley Forge, uses 960-mc equipment (RCA Type CW5A). The through microwave stations carry this circuit to Everett, Pa. and the Everett Control Center. The western division microwave circuit originates at Everett and stretches to the Ohio border and the western terminus near Petersburg, Ohio, through an additional five relays. A second control point is located at the Harrisburg office, the source of administration for Turnpike affairs. The basic voice circuits are divided into eastern and western divisions at Everett to separate the traffic load for greater flexibility and ease in handling. The Teletype circuit and the administrative voice circuit

is tied through from east to west.

Nine Teletype outlets are provided at the key points including the east and west terminals, the Harrisburg office, and the Everett Control Center. At each relay station (13 total) is located a vhf receiver (RCA CR9A) and a vhf transmitter (RCA Type CT12A). The receivers pick up signals originating within their individual range from a fixed station (an interchange, a maintenance building, or a police barracks) or a mobile unit, and inject this signal into the microwave circuit. Once the signal is originated into the microwave circuit it is automatically retransmitted by all of the vhf transmitters on the particular circuit (east or west).

The instant a signal originates at any given point in the system it electronically locks out the possibility of a second signal gaining con-

UHF Communications System

Microwave circuits used in conjunction with existing vhf equipment provide ultimate in dependability and efficiency of communications system. Topography along 327-mile route from outskirts of Philadelphia to Ohio border presents unique problems

By D. N. LAPP

*Chief, Field Operations
Raymond Rosen Engineering Products
Philadelphia, Pennsylvania*

trol until the transmission is complete. The control and lockout is accomplished by the use of sub-carrier tone transmitters (Lenkurt) and tone receivers in conjunction with special switching circuits.

All vhf transmitters at the relay station operate on one frequency in the 152 to 162 mc band. All other mobile and fixed station transmitters on the Turnpike use a second frequency in the same band. Thus, a signal from a mobile unit is received at a relay station and then rebroadcast and received at the other mobile and fixed stations on the Turnpike.

The microwave relay stations use

a heavy-duty fire tower (Aermotor Corp.) type construction with cabin atop. The equipment and parabolic antennas are mounted so as to provide minimum transmission-line loss. The equipment is installed in racks mounted within the cabin and 4-ft and 6-ft parabolic antennas (Andrew Corp.) feed the signal cross country.

Each relay station is operated from commercial power and a stand-by 3 or 5-kw gasoline-powered generator (Kohler) is provided to take over instantly in the event of an emergency. These generator houses are located adjacent to the base of the tower at each of the relay locations.

The highest tower in the entire system is at the Ohio Gateway microwave terminal, and this is a 150-ft guyed steel tower (Stainless Inc.) with the equipment mounted in a transmitter building at the base of the tower. This tower is adjacent to the interchange and the transmitter is remotely controlled from the interchange.

Interchange Buildings

There are a total of 43 interchange and maintenance buildings across the entire Turnpike, most of which originate signals in the vhf band. All of these fixed vhf stations use (RCA CTR1A) 15-watt 152 to 162-mc f-m transmitter-receivers. These stations also use a Yagi antenna (Andrew) pointed in the direction of the nearest relay

station. These antennas are mounted on 40 or 75-ft steel masts erected near the building.

Each of the transmitters is modified for a standard two-wire telephone switching circuit.

Many of the interchanges require operating points in the utility building in addition to the toll booth or booths directly adjacent to the utility building. The radio equipment is installed in the utility building on wall-mounting racks. Press-to-talk telephone type simplex operation is provided with a line amplifier and speaker at each handset location for audible monitoring. When the handset is picked up from the hanger or cradle, the speaker mutes and telephone-type transmission and reception is obtained.

All interchanges and maintenance buildings are provided with gasoline-driven emergency generators which automatically take over when the commercial power fails.

A standard mobile unit with a 30-watt f-m transmitter and receiver (RCA Type CMV4A) is used in the Turnpike equipment. These units are located in the police cars, those of the highway maintenance supervisors, and all other Turnpike vehicles requiring direct contact with the control centers of the Pennsylvania Turnpike Radio System.

To better acquaint the reader with the microwave system, it is desirable to trace a typical point-to-point transmission. This description used in conjunction with the overall system layout will give a better illustration of the manner in which typical messages originate.

Assume that a police patrol car is moving along the Turnpike near



Thirteen two-way microwave relay stations of the type shown furnish dependable communications along the route. Average hop is 24 miles

Harrisburg, Pa. and comes upon a situation which requires assistance. The officer listens to make certain that the eastern division is not in use and then depresses his press-to-talk button to call the New Cumberland maintenance building and summon an ambulance. His 155-mc f-m transmitter signal is delivered to the receiver at the Bunches relay station and modulates the f-m transmitter at that point, in addition to transmitting the signal both east and west from Valley Forge to Everett on the microwave through circuit. All of the stations in the eastern division, in addition to the New Cumberland maintenance building, hear the signal and realize that an emergency exists. During periods like this, normal traffic stands by until the condition is properly taken care of.

Emergency Action

The New Cumberland maintenance building would receive the signal through their Yagi antenna and associated fixed station receiver. They would immediately reply and advise that the request is being complied with. In the event of an emergency where it is necessary to absolutely stop other traffic, the control operator at Harrisburg or at Everett takes command of the system and keeps the circuit clear until the emergency has passed. Standard coded signals as used by the State Police are used through-

out of the entire Turnpike system.

At any point where microwave facilities are available a Teletype station can be installed. The equipment operates on a subcarrier which after being received at a microwave station and demodulated, can be placed into any standard two-wire circuit to a Teletype machine.

The Teletype printers presently in use on the Turnpike are installed at the eastern and western terminus, the Harrisburg office, and the Everett Control Center plus certain of the tunnel stations requiring this service. The tunnel stations are fed by cables which are buried under ground and come down the side of the mountain from the relay stations on top. These cables, incidentally, are from the old original radio system installed in the first Pennsylvania Turnpike system stretching from Carlisle to Irwin (116 to 119 mc, see *ELECTRONICS*, May 1942).

Antennas

The microwave equipment uses standard antennas of the 2, 4 and 6-ft parabola types. The size of the dish is determined on the basis of the signal required as determined by the original survey made across the state before the actual relay sites were established.

All interchanges and maintenance buildings use the Yagi-type antenna beamed at the proper relay



Emergency power stations at each relay position insure communications in the event of regular power system failure

station. In some cases a corner-reflector antenna (Andrew) is used to provide signal improvement. The fixed relay stations vhf and uhf receivers use omnidirectional (Andrew 704A2) antennas since the signals being received and transmitted are required to reach points both on and off the Turnpike right-of-way.

Survey

The Pennsylvania Turnpike System for the proper coverage from Valley Forge to the Ohio Border required a comprehensive study of topographical maps to determine the approximate locations and the length of the microwave jumps prior

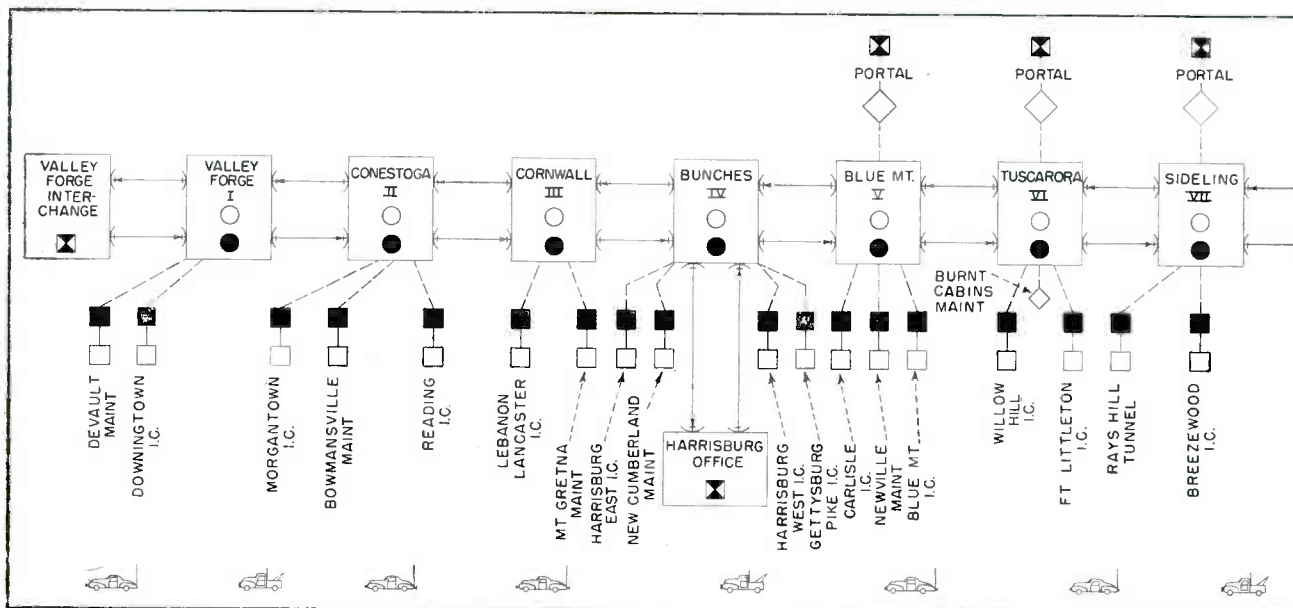

System layout plan shows communications equipment used at various points along



All mobile units transmit on a common frequency (159.21 mc) and receive on a separate common frequency (155.67 mc). When a mobile operator presses his "talk" button, he automatically takes over the microwave system and his message is relayed to all appropriate stations

to the actual installation of the equipment. The maximum jump in the system is 40 miles and the average jump is 24 miles.

After the locations had been approximately determined it was necessary to conduct an actual radio survey, and on the basis of survey signals the losses were calculated and the proper tower height and antenna size was determined. From this survey the locations were pin pointed and the necessary acquisition of land, construction of roads, towers, and buildings, plus the extension of power line facilities was made.

The basic microwave system from Valley Forge to Pittsburgh was

started in April 1950 and the eastern end was in test operation in October 1950. The entire system from Valley Forge to the Pittsburgh Interchange has been in operation by the Pennsylvania Turnpike since May 1951.

A total of 104 mobile units are in operation across the Turnpike, and the entire system is serviced on a continual basis by three men plus a supervisor. Service records for the first few months indicate few service problems and a minimum loss of microwave circuit time.

The microwave circuits to the Ohio border are being completed and will be in operation in conjunc-

tion with the opening of the roadway.

5,991 Tubes

The microwave vhf relay and terminal stations use a total of 2,202 tubes. Interchanges and maintenance buildings account for another 1,293 tubes plus 2,496 tubes in the mobile equipments. Thus, the entire system uses a grand total of 5,991 tubes. A single two-way operation requires very close to 1,000 tubes for complete operation.

This complete comprehensive system sets a pattern for radio systems to fulfill a communication need which radio alone can serve.

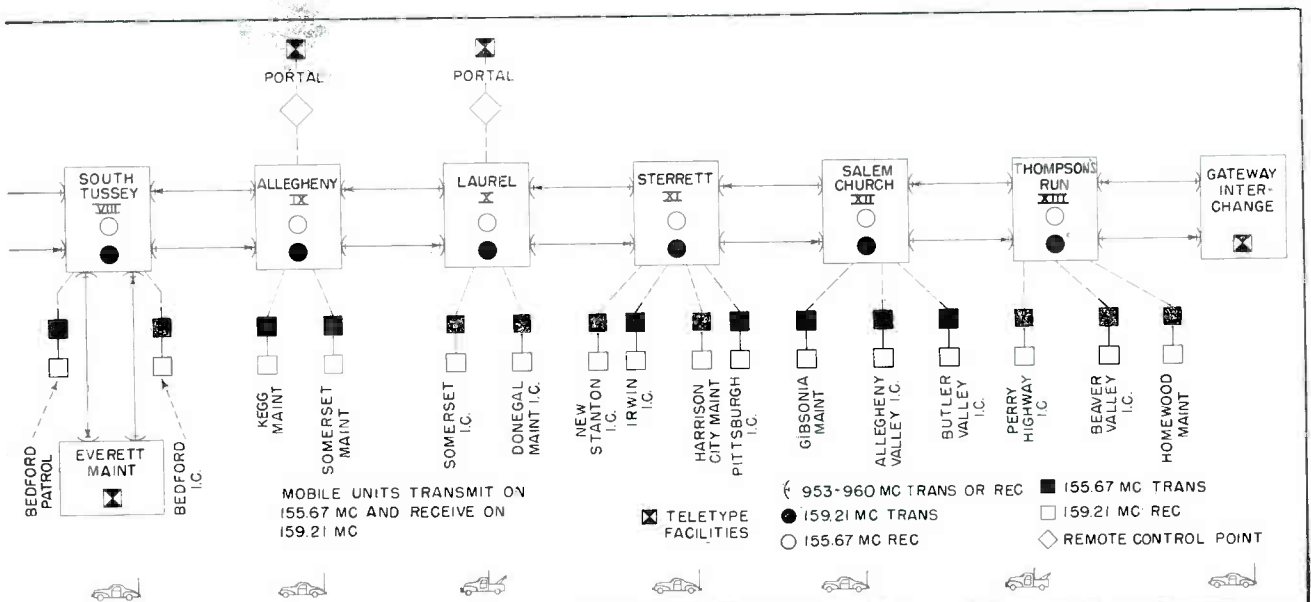

the 327-mile Pennsylvania Turnpike. The complete system uses almost 6,000 tubes

Principles of NTSC COMPATIBLE

By **C. J. HIRSCH**
Chief Engineer, Research Division

W. F. BAILEY
Supervising Engineer
Hazeltine Corporation
Little Neck, N. Y.

B. D. LOUGHLIN
Supervising Engineer

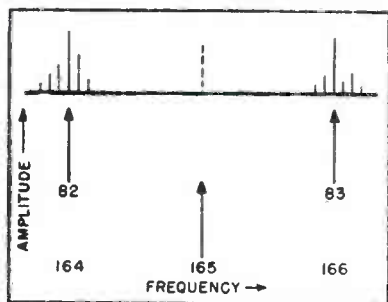

FIG. 1—Energy concentrations in tv signal. Upper numbers are harmonics of line frequency, lower numbers harmonics of half line frequency

FIG. 3—Complete video spectrum of NTSC field-test signal; f_h is the horizontal scanning frequency

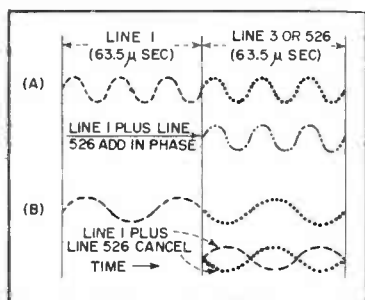
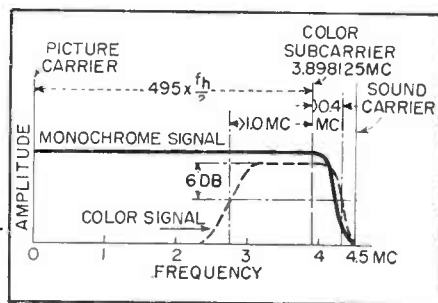

FIG. 2—Cancellation of coloring information: (A) even harmonics of half line frequency reinforce each other on successive scanning of same line; (B) odd harmonics cancel out

FIG. 4—Dot pattern corresponding to fruit in bowl. Plate A on ELECTRONICS front cover, when monochrome signal is absent and alternate frames are suppressed



THE SPECIFICATION of color requires three independent quantities such as the intensity of three primaries, red, green, and blue. In a color television system, this might seem to imply three separate and complete high-resolution pictures, one in each primary color. However, it is a fact that the eye can distinguish small changes in brightness (both in space and time) whereas color changes are much

less easily resolved. Hence it has been shown that a color picture need not contain three times as much information as a monochrome picture.

A satisfactory color picture need contain only slightly (10 to 80 percent) more information than the same picture in monochrome^{1,2,3}. To achieve this economy, color should be expressed in another set of three subjective quantities, luminance, dominant wavelength, and purity, (corresponding to brightness, hue and saturation) and the color picture should be sent as a full-resolu-

tion monochrome picture to which the minimal requisite color information is added.

In the color television method now being field tested by the NTSC⁴, the information is transmitted by two simultaneous signals. One of these is called the monochrome signal and supplies all the luminance, (brightness) information. This signal is transmitted by the present FCC standards for black-and-white television and may be received by any black-and-white receiver without any change whatsoever. The other signal is called

Presented at the IRE-RTMA Radio Fall Meetings, Toronto, Oct. 1951.

a phase reversal on successive lines and line 526 cancels the information on line 1.

The cancellation would be complete if the system were linear, and if the eye had complete refectivity from frame to frame. This is not entirely the case, because the system is only approximately linear, and the eye cancels only that part of the color modulation which it remembers from frame to frame. For this reason only a part of the amplitude of the color information cancels itself out. If the coloring signal is transmitted at too high a level, the peaks of the color subcarrier and its sidebands appear as dots in the colored parts of the transmitted picture when viewed on a monochrome receiver.

Figure 4 illustrates in exaggerated form the dot pattern corresponding to a portion of the picture

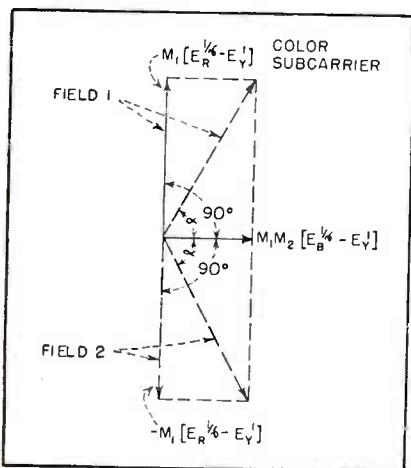

FIG. 6—Phase relations between modulation components of the color subcarrier on successive fields

in Plate A on the front cover. This image appears when only the color subcarrier is transmitted, and when only alternate frames are displayed, so as to make the interfering pattern most evident. This exaggerated condition never appears in practice since the monochrome component is always present for any color (except black) and because cancellation results when all frames are displayed.

To transmit the color subcarrier at high enough amplitude for adequate signal-to-noise ratio and yet make the dot pattern invisible, the

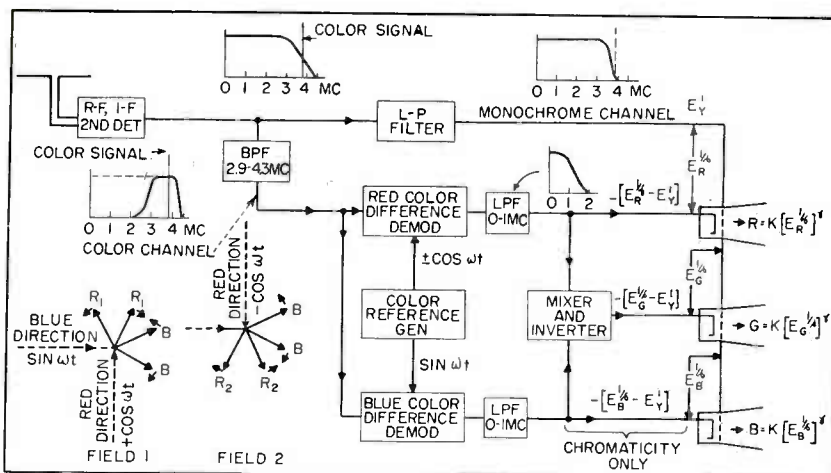

FIG. 7—Block diagram of typical equipment for receiving NTSC field test signal

frequency chosen for the subcarrier is high enough (3.898125 mc) to be attenuated considerably by existing monochrome receivers. This frequency is equal to the 495th harmonic of half line-frequency (See Fig. 2).

Monochrome Signal

The monochrome signal voltage, E_v , can be obtained directly from a camera whose output is proportional to luminance. More usually it is made up by combining voltages (E_R , E_G , and E_B related to the red, green, and blue reproducing primaries) which are derived from a three-color camera. In the latter case, the three components E_R , E_G , and E_B are combined in proportion to their contribution to the total luminance.

The luminance signal is made up as follows:

$$E_v = 0.59 E_G + 0.30 E_R + 0.11 E_B \quad (1)$$

This expression indicates that the green, red, and blue reproducing primaries* contribute respectively 59, 30, and 11 percent of the luminance of white (defined by the chromaticity coordinates $x = 0.310$; $y = 0.316$, that is, illuminant C). Note that the sum of the numerical factors in Eq. 1 is unity.

The system is so proportioned that white is produced when $E_R = E_G = E_B$. Hence for white light, substituting in Eq. 1.

$$E_v = E_R = E_G = E_B \quad (1a)$$

* Standard reproducing primaries are red $x = 0.670$; $y = 0.330$; green $x = 0.210$; $y = 0.710$; blue $x = 0.140$; $y = 0.080$.

It is evidently desirable that the coloring information disappear when there is no color. For this reason, this information is transmitted in terms of two components ($E_R - E_v$) and ($E_B - E_v$) which are called "color difference" signals.¹⁰ From Eq. 1a ($E_R - E_v$) = $0 = (E_B - E_v)$ for white light (no color).

Color-Difference Signals

Since the eye is insensitive to color in fine detail, these color-difference signals are usually, but not necessarily, limited in bandwidth to 1 or 2 mc.⁸

Green, when present, is transmitted by these signals even though it does not appear explicitly. Green is, as Eq. 1 states, the main component of E_v . The color receiver recovers ($E_R - E_v$) and ($E_B - E_v$). The receiver can obtain ($E_G - E_v$) by a mixture of $-0.51 (E_R - E_v)$ and $-0.19 (E_B - E_v)$, as shown below.

Substituting Eq. 1 in ($E_R - E_v$) and ($E_B - E_v$) we obtain

$$\begin{aligned} & -0.51 (E_R - E_v) - 0.19 (E_B - E_v) \\ &= -0.51 (-0.59 E_G + 0.70 E_R - 0.11 E_B) \\ & \quad - 0.19 (-0.59 E_G - 0.30 E_R + 0.89 E_B) \\ &= 0.41 E_G - 0.30 E_R - 0.11 E_B \\ &= E_G - (0.59 E_G + 0.30 E_R + 0.11 E_B) \\ &= E_G - E_v \end{aligned} \quad (2)$$

The color receiver adds the luminance signal to each color-difference signal as follows:

$$(E_R - E_v) + E_v = E_R \quad (3a)$$

$$(E_B - E_v) + E_v = E_B \quad (3b)$$

$$(E_G - E_v) + E_v = E_G \quad (3c)$$

The voltages E_R , E_G , and E_B are applied between the respective control grids and cathodes of a three-

gun color picture tube.⁷ This may be done by applying E_v to one electrode, and the color-difference signal to the other.

Gamma Correction

The foregoing discussion is oversimplified because the light output (L) of the picture tube is not directly proportional to the electrical input (E) but varies approximately as a power (γ) of this input as

$$L = K E^\gamma \quad (4)$$

The voltages applied to the picture tubes must therefore be pre-distorted by a process called gamma correction. One way in which this may be done is by transmitting the following signals:

1. A monochrome signal made up of gamma-corrected primary voltages described as follows:

$$E_v' = 0.59 E_G^{1/\gamma} + 0.30 E_R^{1/\gamma} + 0.11 E_B^{1/\gamma} \quad (5)$$

2. The two "color-difference" components ($E_R^{1/\gamma} - E_v'$) and ($E_B^{1/\gamma} - E_v'$).

Complete Color Signal

A scheme for generating the complete color signal, shown in Fig. 5, uses individually gamma-corrected primary voltages. These are mixed to form the monochrome and color-difference signals.

A sine wave can carry two independent sets of information by modulating it in amplitude with one set and in phase with the other or, what is essentially the same thing, by splitting the sine wave into two components in quadrature and amplitude modulating each component with one set of information. Each modulation can then be recovered by heterodyning the modulated wave with a sine wave having the same frequency and phase as the carrier component carrying the desired modulation. This process is sometimes called synchronous detection and must not be confused with other forms of detection which recover the modulation envelope.

The information which is utilized to establish the reference frequency and phase at the receiver⁸ is transmitted by a few cycles of the reference signal, called the color burst, on the horizontal blanking pulse following the line synchronizing pulse (see paper by R. B. Dome, this issue). Its frequency is that

of the color subcarrier (3.898125 mc), and it leads the phasor representing the blue color-difference component of the modulated wave by 90 deg.

Referring to Fig. 5, we see that ($E_B^{1/\gamma} - E_v'$) is made to modulate $\sin \omega t$; while ($E_R^{1/\gamma} - E_v'$) modulates $\pm \cos \omega t$. Balanced modulators are used so that the subcarrier is suppressed on white light. The outputs of the two modulators are first combined with each other to form a single color subcarrier signal and then combined with the monochrome signal to complete the

phase alternation, allows the use of vestigial sideband operation for the color subcarrier, as described later.

Phase Equalizer

The relative phase of the two sets of sidebands is shown in Fig. 5, near the respective modulator output leads. The phasors representing the color subcarrier components of Eq. 6 are shown in Fig. 6. It is evident that the phase angle α of the color subcarrier with respect to the ($E_B^{1/\gamma} - E_v'$) component depends on the ratio of the two color-difference components, and therefore on the hue (dominant wavelength) of the picture. The amplitude depends on saturation (purity) since it is seen to disappear on white. The amplitude depends also on luminance since it is seen to involve absolute values of E_R , E_B , and E_v .

The complete color signal is impressed on the phase equalizer unit whose function is to modify the delay of the low-frequency portion of the monochrome signal with respect to the high-frequency portion and the color subcarrier to insure time-coincidence at the second detector of a typical receiver.⁹ This is desirable because the receiver selectivity results in delaying high modulation frequencies, where the color subcarrier is located, more than low frequencies. The complete color signal then is applied to the r-f transmitter whose useful output is frequency limited in practical receivers so that vestigial sideband transmission of the color subcarrier results (See Fig. 2).

Color Receiver

Figure 7 shows a block diagram of a typical receiver. The complete color signal, monochrome plus color subcarrier, is applied to the three grids of the picture tube. This signal drives the three grids equally and produces a monochrome picture as shown in Plate C on the front cover. Some reduction of the color subcarrier in the monochrome path to the picture tube may be desirable to eliminate color desaturation due to picture tube nonlinearity. This can be accomplished by a low-pass filter located in this path.

The signal is also applied to the

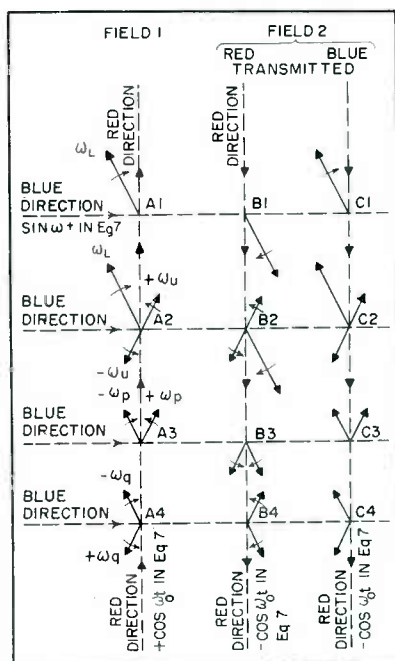

FIG. 8—Cancellation of crosstalk produced by vestigial sideband transmission: A1-4 red and blue on field 1, B1-4 red on field 2, C1-4 blue on field 2

color picture signal E_m , whose equation is

$$E_m = E_v' + M_1 [M_2 (E_B^{1/\gamma} - E_v') \sin \omega t \pm (E_R^{1/\gamma} - E_v') \cos \omega t] \quad (6)$$

In this formula, the phase reference is $\cos \omega t$ (which is that of the color synchronizing signal), M_1 determines the amplitude of the color subcarrier relative to the monochrome signal E_v' , and M_2 determines the relative proportions of the two color-difference components.

The phase of the ($E_R^{1/\gamma} - E_v'$) component is reversed after each field. This is the meaning of the \pm sign. This process, known as color

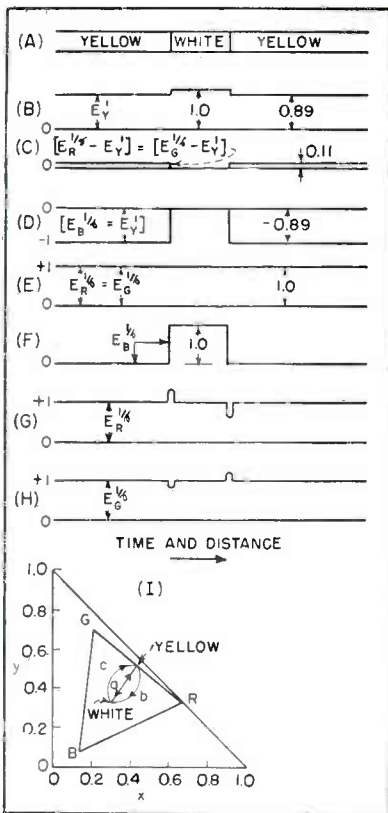

FIG. 9—Waveforms (A-H) which produce yellow-white bars shown in Plate E on front cover. At (I), a is the path traversed in the chromaticity diagram in going from white to yellow when using symmetrical sidebands; b and c are the paths when using vestigial sidebands

demodulators through a separate path. A bandpass filter is inserted in this circuit to attenuate the low-frequency monochrome components and sound carrier beats. The demodulation will be described first as if the signal had double sidebands. Then the correction required for the vestigial sideband transmission actually used will be described.

The color subcarrier signal applied to each demodulator consists of two sets of sidebands as shown in Fig. 7 (fields 1 and 2) with respect to the two quadrature carrier components. The phase of one of these carriers is in the $(E_B^{1/\gamma} - E_y')$ direction, and the other in the $(E_R^{1/\gamma} - E_y')$ direction. If the color subcarrier is heterodyned with a signal having the subcarrier frequency, and in phase with the $(E_B^{1/\gamma} - E_y')$ direction ($\sin \omega t$) the result, after filtering r-f terms, will consist of the $(E_B^{1/\gamma} - E_y')$ signal because the sidebands of only that signal can change the magnitude of

the heterodyning signal (the sidebands of the $(E_R^{1/\gamma} - E_y')$ signal cancel in the $(E_B^{1/\gamma} - E_y')$ direction). Likewise the $(E_R^{1/\gamma} - E_y')$ signal can be recovered by heterodyning with $\pm \cos \omega t$. If, however, the heterodyning signal has a phase which is other than 0° or 90° with respect to the two color-difference components, the output will be a mixture of the two.

The following analysis may help to clarify this point. Assume that the color subcarrier is being heterodyned by a signal represented by $2 \sin(\omega t + \theta)$. Then the output E_o of the demodulator is

$$E_o = [M_1 M_2 (E_B^{1/\gamma} - E_y') \sin \omega t \pm M_1 (E_R^{1/\gamma} - E_y') \cos \omega t] 2 \sin(\omega t + \theta) \quad (7)$$

$$= 2M_1 M_2 (E_B^{1/\gamma} - E_y') \sin \omega t \sin(\omega t + \theta) \pm 2M_1 (E_R^{1/\gamma} - E_y') \cos \omega t \sin(\omega t + \theta) \quad (8)$$

The following trigonometric identities apply

$$\sin \omega t \sin(\omega t + \theta) = 1/2 \cos \theta - 1/2 \cos(2\omega t + \theta) \quad (9)$$

$$\text{and } \cos \omega t \sin(\omega t + \theta) = 1/2 \sin \theta + 1/2 \sin(2\omega t + \theta) \quad (10)$$

Terms having 2ω in Eq. 9 and 10 are eliminated by the lowpass filter in the demodulator output. Hence there remain

$$\sin \omega t \sin(\omega t + \theta) = 1/2 \cos \theta \quad (9a)$$

$$\cos \omega t \sin(\omega t + \theta) = 1/2 \sin \theta \quad (10a)$$

substituting, Eq. 9a and Eq. 10a in Eq. 8

$$E_o = M_1 M_2 (E_B^{1/\gamma} - E_y') \cos \theta \pm M_1 (E_R^{1/\gamma} - E_y') \sin \theta \quad (11)$$

$$= M_1 M_2 (E_B^{1/\gamma} - E_y') \text{ if } \theta = 0 \quad (12)$$

$$= \pm M_1 (E_R^{1/\gamma} - E_y') \text{ if } \theta = 90^\circ \quad (13)$$

From the above derivation we

see that the receiver can separate the red and blue color difference signals by applying the signals to two synchronous demodulators, to which is also applied a reference voltage of the proper phase.

If θ equals neither 0 nor 90 deg, that is, if there is a phase shift between the color subcarrier and the reinserted reference signal, then the modulator output will contain terms from both color difference signals and color contamination results, as shown by Eq. 11. This color contamination is greatly minimized by means of color phase alternation.

The $(E_G^{1/\gamma} - E_y')$ video signal is obtained from the other two as shown in Eq. 2 and Fig. 7.

The three color-difference signals may then be applied to the respective cathodes of the color picture tube. Since the tube is operated by the cathode-grid voltage, the light output of the green gun is

$$L = K(E_G^{1/\gamma} - E_y' + E_y')^\gamma = K E_G$$

and likewise for the other guns.

Notice that all the items of information required to define a picture element in luminance (E_y'), and in chromaticity ($E_R^{1/\gamma} - E_y'$; $E_G^{1/\gamma} - E_y'$; $E_B^{1/\gamma} - E_y'$) are present simultaneously.

Crosstalk Due to Vestigial Sideband

Vestigial sideband modulation of the color subcarrier for high modulation frequencies is brought

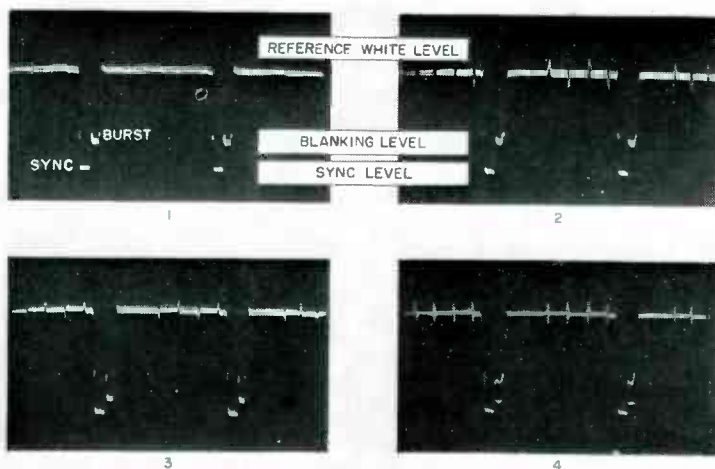

FIG. 10—Oscillograms of signal applied to red electron gun when reproducing yellow-white bars of Plate E, front cover

about by the necessity of transmitting and receiving the complete signal within a band of not more than 4.5 mc. The use of *single-sideband* modulation, as contrasted with vestigial sideband, results in the division of the power equally between amplitude and phase modulation for these modulation frequencies.

Stated in another way, single-sideband transmission results in two sets of equal sidebands, one set being in phase and the other set in quadrature with the carrier. This is shown in Fig. 8.

Fig. 8A1 represents a carrier ω_c having a lower sideband ω_l of frequency $(\omega_c - \omega_l)$. Fig. 8A2 represents the same signal except that an upper sideband $+\omega_u$ having half the amplitude of the lower sideband, has been added symmetrically about the carrier. However, another signal $-\omega_u$, equal and opposite in phase to $+\omega_u$, has also been added. This leaves the signal of Fig. 8A2 identical with that of Fig. 8A1.

The sidebands of Fig. 8A2 can now be distributed, as shown in Fig. 8A3 and 8A4 to represent modulation in phase ($+\omega_p$ and $-\omega_p$) and in quadrature ($+\omega_q$ and $-\omega_q$) with the carrier. Thus to red color difference signal, amplitude-modulating a carrier by means of double sidebands, will, on losing one sideband, have part of its energy transferred to a component in quadrature with the carrier, which will then appear as a spurious signal registering in the blue color difference channel.

Since observers are quite critical of the hue of the colors in large areas in reproduced pictures (faces, for instance), it is highly desirable that the sidebands for low modulation frequencies (say up to 0.4 mc) of the components of the color subcarrier be transmitted by vestigial rather than true single-sideband transmission. The slope of the overall passband in the region of the color subcarrier should be gradual enough to change from essentially zero to maximum transmission in about 0.8-mc bandwidth. This minimizes the color crosstalk in large area color which otherwise could occur as shown in Fig.

8A by using single-sideband transmission of the color subcarrier.

Color Phase Alternation^{4,10}

It is desirable to use a high frequency for the color subcarrier to reduce its visibility in black-and-white receivers. This limits the frequency range over which upper-sideband transmission may be used for the color subcarrier components. However, the lower sidebands may extend for a considerable range, one or two megacycles below the color subcarrier. These unequal sidebands result in crosstalk of each component of the color subcarrier to the other one, as discussed in the previous section. While this crosstalk cannot be eliminated

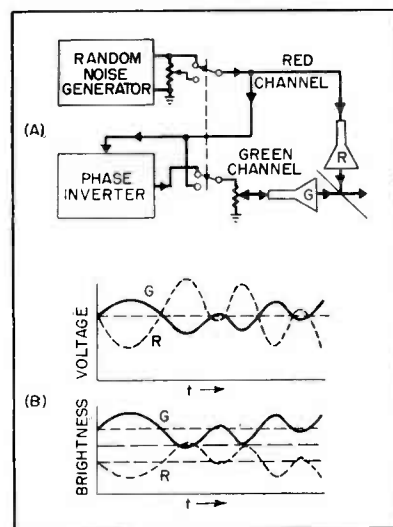

FIG. 11—Test set-up (A) for measuring annoyance of luminance noise vs color noise. Voltage fluctuations and corresponding brightness fluctuations in constant-luminance transmission are shown at (B)

in the electrical signals, it may be effectively neutralized at the eye by reversing the phase rotation of the color subcarrier components after every field at the transmitter, and simultaneously making the corresponding change in the receiver demodulators.

In this process, called color phase alternation, the quadrature component which results in an excess of blue (or red) in one field also results in a deficiency of blue (or red) in the next field. This alternation between excess and deficiency occurs on adjacent lines in the pic-

ture and averages out because the eye cannot see color in fine detail.

The process is demonstrated in Plate E on the front cover which shows a yellow stripe followed by white and a return to yellow. The stripe shown at the top was obtained with double-sideband transmission and shows no contamination.

A voltage-time diagram is given in Fig. 9 for different parts of the receiver when receiving this stripe. Figure 9A shows the time-space distribution of the stripe. The luminance signal E_y' applied equally to the grids of the three guns is shown in Fig. 9B. Its amplitude is found by substituting $E_a = E_r = 1$ and $E_b = 0$ (for the yellow region) and $E_g = E_r = E_b = 1$ (for the white region) in Eq. 5. The value of E_y' is equal to $0.59 + 0.30 = 0.89$ for yellow and $0.59 + 0.30 + 0.11 = 1.0$ for white.

Figure 9C shows the amplitude of the red and green color difference signals. This is $(E_r^{2/\gamma} - E_y')$ $= 1.0 - 0.89 = 0.11 = (E_g^{2/\gamma} - E_y')$ for the yellow area and $(E_r^{2/\gamma} - E_y') = 1.0 - 1.0 = 0 = (E_g^{2/\gamma} - E_y')$ for the white areas. Figure 9D shows the amplitude of the blue color difference signal. It is equal to $E_b^{2/\gamma} - E_y' = 0 - 0.89 = -0.89$ for the yellow areas and $1.0 - 1.0 = 0$ for the white area.

Figure 9E shows the total color signals applied to the red and green guns. It is made up of the sum of the signals of Fig. 9B and 9C and is constant at unity. Figure 9F shows the signal applied to the blue gun. It is equal to zero during the yellow stripe and to unity for the white area (because $E_r = E_g = E_b = 1$ for white).

When the picture is transmitted by vestigial sidebands, as is the case for the second row of Plate E, the signal cannot go directly from yellow to white and back to yellow. Instead, the color subcarrier undergoes a phase shift for one transition and an opposite phase shift for the other transition. Stated in other words, the red and blue color difference components of the subcarrier produce crosstalk on each other, and excite the red and green guns, as shown in Fig. 9G and 9H. The crosstalk introduced at the blue gun has negligible

effect in this case. The shift in hue can be understood by referring to Fig. 9I which plots the hue shift on the CIE chromaticity diagram. This hue shift is seen, in the second row of Plate *E*, at the edge between yellow and white, which is contaminated with orange, and at the edge between white and yellow which is contaminated by green. There is no color shift in the main yellow areas because these require only low frequencies which are transmitted with nearly symmetrical sidebands.

The third row of Plate *E* was obtained for the same condition as those of the second row except that the phase of the red color difference component of the subcarrier was reversed. The contamination at the edges are opposite in sequence to those in the second row of Plate *E*.

In the fourth row of Plate *E*, the red color difference signal leads and lags the blue color difference signal on alternate fields so that adjacent lines in the picture have opposite color contamination with resultant visual cancellation.

Red-Gun Signal

Figure 10 is an oscillogram of the waveform of the voltage applied to the red gun when transmitting Plate *E*. The signal labeled (1) in Fig. 10 corresponds to the top row and was transmitted with symmetrical sidebands. No crosstalk is apparent. The signals labeled (2) and (3) were obtained when transmitting the second and third row of Plate *E* respectively. These signals are seen to be contaminated by an excess of red, followed by a deficiency, at the edges for one signal and with an opposite contamination for the other signal. The signal labeled (4) was photographed when transmitting several fields corresponding alternately to signals (2) and (3) of the fourth row of Plate *E*. The contaminations of opposite polarity are clearly seen.

Cancellation in Large Color Areas

A phase shift, between the color subcarrier and the demodulating reference signal, results in color contamination even for large areas of unchanging color where symmetrical sidebands are received¹⁰. This is evident from Eq. 11 above



FIG. 12—Visible effect of c-w interference when using constant-amplitude transmission. Annoyance of bars is reduced about 8 db with constant-luminance transmission

which shows, for values of θ close to zero, that some red color difference signal is added to the blue color difference signal if only the plus or the minus sign is used. Likewise some blue color difference signal is added to the red color difference signal for values of θ close to 90 deg. This equation also shows the means of cancelling this crosstalk.

The output of the blue color difference demodulator is alternately raised and lowered on successive fields by an amount equal to $M_r(E_r^{uv} - E_r')$ sin θ . The equivalent, of course, occurs in the output of the red color difference demodulator. Since this occurs on alternate fields, and, therefore, on adjacent lines in the picture, the effect cancels out.

Plates *A* and *B* on the front cover illustrate this cancellation. Plate *A* was obtained with color phase alternation and 20 deg misphasing of the receiver reference signal. No difference in color values could be observed visually on reducing this phase error to zero. However, Plate *B* shows the two individual fields which, when interlaced, result in the picture on Plate *A*.

The left-hand picture of Plate *B* shows a counterclockwise shift in

the CIE chromaticity diagram; the cup is too blue and the fruit appears less ripe than in Plate *A*. The right-hand picture of Plate *B* shows a shift in the opposite direction; the cup is too green and the fruit is more ripe. This is one case where two wrongs do make a right!

The large tolerance to phase error and the ability to use vestigial sidebands, made possible by color phase alternation, eases the design of intermediate-frequency amplifiers because less attention need be paid to the flatness of the amplitude and delay characteristics in the vicinity of the color subcarrier frequency.

Color vs Luminance Fluctuations

Studies of flicker using lights having different colors show that the eye is less sensitive to chromaticity than to luminance fluctuations. This suggests that the conversion of noise and other perturbations from luminance to color, wherever possible, might result in a reduction of their visibility¹⁰.

To determine the relative annoyance value, the apparatus shown in Fig. 11A was set up. The background controls of the green and red tubes were adjusted to give a flat bright yellow field. The yellow

color was adjusted so that the addition of a suitable blue would give a reasonable white. Then opposite-polarity noise was applied to the two picture tubes. Upon adjusting the amplitude of the noise applied to the green channel, the normal observer would find a critical balance point at which the annoyance value of the noise was reduced. This corresponded to constant luminance conditions as shown in Fig. 11B.

Similar-polarity noise at reduced amplitude was then applied, by throwing the double-throw switch, and the observer was requested to adjust for substantially the same annoyance value as that obtained under the constant luminance conditions.

Data from a small group of observers indicated that about 8 db more noise could be tolerated for the same degree of annoyance when the noise had only chromaticity fluctuations.

Constant Luminance Transmission

The monochrome channel of a color receiver is no more subject to noise or interference than a monochrome receiver of the same resolution. However, these perturbations may affect the color channel to an appreciable extent unless suitable precautions are taken¹¹. The demodulators heterodyne interference, noise, and components from the luminance signal, whose frequency is close to that of the subcarrier, to a lower frequency where it becomes coarser and more visible.

Figure 12 shows the effect of c-w interference, whose frequency is 500 kc lower than the subcarrier, in a receiver built for an earlier version of the color signal. In that version, an appreciable part of the luminance was supplied by the color channel.

This receiver made use of three demodulators, having equal gains and heterodyned by three equal voltages 120 deg apart. The 500-kc luminance beat note is clearly visible in Fig. 12. This beat note varies the luminance and chromaticity.

Since the outputs of the three demodulators are equal in amplitude and differ by 120 deg in phase, the total intensity coming from the

picture tube should cancel. This would be the case were it not for the fact that the eye is more sensitive to green than to red, and is least sensitive to blue. The result is that variations of equal intensities in green, red, and blue result in unequal sensations when combined by the eye, and therefore there is no cancellation. This is made clearer by reference to Fig. 13 which shows how the three guns of the picture tube are excited by the beat note as a function of time. The lower part of this figure shows how this fluctuation in time is translated to one in space as the electron beam scans. It also shows the unequal sensations of brightness evoked from green, red, and blue when equally excited. Finally it shows the total brightness fluctuation which appears in Fig. 12.

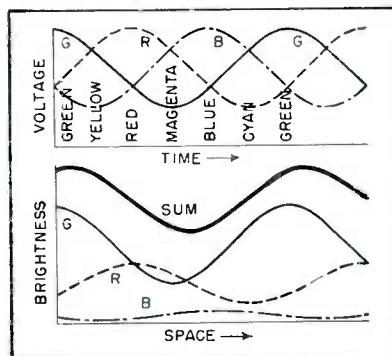

FIG. 13—Voltage and brightness waveforms for interference pattern of Fig. 12. Note that voltage variations cancel but brightness variations do not

The visibility of the interference can be greatly reduced by so proportioning the signal that the combined outputs of the demodulators result in no brightness fluctuation. When this is done, the beat note is one of chromaticity only and is greatly reduced in visibility. It is for this reason that the complete color signal is transmitted in such a manner that the monochrome signal supplies all the luminance information while the color subcarrier supplies only variations in chromaticity.

Plate A, the complete color picture, is made up by adding the electrical signals which produced Plate C to those which produced plate D. Plate C is obtained when only the

monochrome channel is operative. It contains all the geometric definition present in Plate A. Plate D is produced when only the color-difference channel functions, and is responsible for all the color in Plate A.

Advantages of NTSC Specifications

Examination of Plate A shows that a system using these specifications is capable of producing color television pictures with the full resolution of which present day monochrome television is capable. In addition it can transmit all the color information that the eye can resolve. This transmission takes place within the bandwidth now allotted to black and white television.

Existing 6-mc monochrome channels are, therefore, adequate for color. Transmitters can readily be converted to color transmission. This color transmission can be received, as a monochrome picture, on any existing black and white receiver without altering the receiver in the slightest degree. Likewise monochrome transmissions can be received on color receivers. This has been accomplished by designing the system to take into account the properties of the viewer's eye, which is the actual terminal equipment of the system.

REFERENCES

- (1) A. V. Bedford, Mixed Highs in Color Television, *Proc. IRE*, Sept. 1950.
- (2) A. V. Loughren and C. J. Hirsch, An Analysis of Color Television System, *ELECTRON. CS.*, Feb. 1951.
- (3) Report of Panel 11, NTSC, p 11-114.
- (4) Report of Panel Actions, Panel 13, NTSC, Panel 13-162, Oct. 23, 1951.
- (5) Pierre Mertz, Television — The Scanning Process, *Proc. IRE*, Oct. 1941.
- (6) U. S. Patent 1,769,920, July 8, 1930, Frank Gray.
- (7) H. B. Law, A Three-Gun Shadow Mask Color Kinescope, *Proc. IRE*, Oct. 1951.
- (8) Report of Panel 14, NTSC, p 14-163.
- (9) R. D. Kell and G. C. Fredendall, Standardization of Transient Response, *RCA Review*, March 1949.
- (10) B. D. Loughlin, Recent Improvement in Band-Shared Simultaneous Color Television, *Proc. IRE*, Oct. 1951.
- (11) Improvements in Dot-Sequential Color Television, *ELECTRONICS*, p 154, Aug. 1950.

BIBLIOGRAPHY

- M. W. Baldwin, Subjective Sharpness of Additive Color Pictures, *Proc. IRE*, Oct. 1951.
- D. G. Fink, Alternative Approaches to Color Television, *Proc. IRE*, Oct. 1951.
- W. T. Wintringham, Color Television and Colorimetry, *Proc. IRE*, Oct. 1951.

NTSC Color-TV

Specification for field testing is a compromise that takes account of existing black and white transmitter and receiver characteristics. Its parameters can easily be varied somewhat as test proceeds

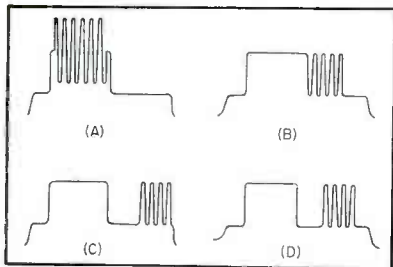

By **R. B. DOME**

*Electrical Consultant
General Electric Co.
Syracuse, N. Y.*

FIG. 1—Alternative positions of color-sync burst signal explained in the text

A CONTINUOUS oscillation wave of stable phase is required at the subcarrier frequency at the receiver by the NTSC color television specifications. This is necessary to perform the function of demodulation of the color information contained in the sidebands of the color subcarrier. The purpose of the color synchronizing signal is to provide information to lock the receiver local subcarrier frequency oscillation generator to a proper reference.

The color information during the picture interval is transmitted as a variable phase and variable amplitude signal of the suppressed-carrier type. Broadly speaking, the hue may be thought of as being represented by the phase of the wave while the saturation data is transmitted by the amplitude of the wave. The amplitude is chosen to be zero for the reference white of the system and since the carrier itself is suppressed, it will be found that neither the subcarrier nor any of its sidebands are transmitted during the picture interval when shades of gray corresponding to different levels of luminosity of white are being dealt with.

It is thus apparent that no use can be made of the color information itself to synchronize the receiver oscillator, and that in fact,

a synchronizing signal separate and distinct from the picture signal must be employed. Since picture transmission occupies all of the time available except that of the blanking intervals, it is necessary to transmit the color subcarrier synchronizing information during the blanking intervals.

Several proposals for synchronizing signal positions in the blanking interval were made before NTSC Panel 14. All proposals chose the subcarrier frequency itself for the oscillation period of the synchronizing signal rather than a submultiple of the color subcarrier frequency such as one-half or one-third of the color subcarrier frequency.

Choice of Subcarrier

The reasoning behind this decision was that the phase relationship between the synchronizing signal and the color subcarrier during the picture interval would not tolerate the phase variation that might exist between them as the receiver tuning changed either as the result of drift in the first-detector oscillator frequency or as the result of manual manipulation of the tuning controls. In a receiver having uniform time delay throughout the video spectrum this would not matter, but practical receivers have some nonuniformity in time delay, particularly in the vicinity of cutoff where the color subcarrier is lo-

cated. It should be pointed out that the phase of the local oscillations must agree with the color subcarrier information to within some ± 5 to 10 degrees if hues are to be reproduced satisfactorily.

Another point of agreement in all proposals was that synchronizing data should be transmitted during every horizontal blanking interval of every picture field but not necessarily during all of the vertical blanking period.

It was agreed that synchronizing information must not be permitted to occupy any of the amplitude range of the composite television signal presently reserved for picture transmission, which means that color synchronizing signals must be kept above the black level of the picture part of the signal. If this were not done, those sets already in the hands of the public, particularly those receivers not having horizontal blanking signals added to the picture tube, would show undesirable spurious picture-tube light output on retrace and hence would not provide a satisfactory working condition.

Another point of agreement was that the synchronizing signal must not impair the operation of synchronizing systems employed in the monochrome receivers already in the hands of the public. This latter decision is basic to the precept of compatibility.

With these points having been agreed upon, the Panel considered several possible positions for the color synchronizing signal within the horizontal blanking interval. Some of these positions are shown in Fig. 1.

Figure 1A shows the subcarrier color synchronizing signal positioned on top of the normal horizontal synchronizing pulse. This

Presented at the IRE-RTMA Radio Fall Meeting, Toronto, Oct. 1951

Synchronizing Signal

method has the advantage of permitting a fairly long train of subcarrier frequency to be transmitted and also it keeps the back-porch clear of signals so that clamping is in no way interfered with. It has the disadvantage that the peak power of the transmitter must be increased to accommodate the increased overall signal amplitude.

At Fig. 1B is shown the train of subcarrier frequency occupying a position on the back porch immediately following the horizontal synchronizing pulse. This method has the advantage of permitting maximum of back-back porch for any of the methods where the color synchronizing signal is not located on top of the horizontal synchronizing pulse. It has the possible disadvantage that transmitter clamps may be confused by such a signal so as to give faulty clamping. This is particularly true for those clamping systems utilizing the trailing edge of the horizontal pulse for triggering the clamping pulse. This method, however, is worthy of some additional study.

Figure 1C shows the color synchronizing signal shifted to the right by the maximum possible amount so that no back-back porch remains. This method results in the maximum length of gap between the horizontal synchronizing pulse and the color synchronizing pulse. It has the advantage of permitting the maximum time for transmitter clamping following the cessation of the horizontal pulse but has the disadvantage in the receiver of allowing for no back-back porch so that any slightly erratic receiver gating might result in passing part of the picture information into the synchronizing channel.

At Fig. 1D is shown a method intermediate between the second two methods. Here the color synchronizing pulse is positioned on the back porch with adequate allowance for a back-back porch but with a somewhat reduced gap between horizontal synchronizing pulse and

color synchronizing pulse. It was generally believed, however, that the gap would be adequate for transmitter clamping and it is this form of color synchronizing pulse that was formally recommended for the initial field tests.

Figure 2 shows this recommended synchronizing pulse in greater detail and includes dimensions and tolerances. This pulse is shown in the form that it may be observed at the point where it is generated and not how it would appear after passing through bandwidth-limited circuits. The burst of color subcarrier frequency has a duration of some 10 cycles.

Omission of Bursts

Some discussion arose concerning the omission of bursts in the equalizing pulse and vertical pulse periods, but it was decided to omit the bursts during these intervals for initial field testing but to add them later if necessary.

The bursts may be utilized in the receiver in any of a number of ways to obtain a continuously running oscillation at the subcarrier fre-

quency for the purposes of synchronous detection of the color information.

A preliminary analysis has been made of the requirements of the continuous wave insofar as phase stability is concerned and it was found that the energy contained in the burst appeared to be sufficient to provide a degree of accuracy so that horizontal scanning synchronizing stability and color data would be provided with about the same degree of immunity from disturbances arising from the presence of random noise along with the signal.

One other matter with which Panel 14 is concerned is that of the question as to whether or not there was a sufficient amount of information present in the standard television waveform to distinguish clearly between odd and even fields so that a synchronizing pulse to identify the respective fields could be derived at the receiver, especially in the presence of noise. The existing information in the waveform is the timing of horizontal pulses with respect to the vertical pulses. On one field the horizontal pulses are coincident with the leading edges of the odd-numbered blocks of the six blocks of the serrated vertical pulse. On the next field the horizontal pulses are so phased that these pulses are coincident with the leading edges of the even-numbered blocks of the six blocks of the serrated vertical pulse.

Suggestions were made regarding the inclusion of additional field-sensing synchronizing pulses so as to provide more positive field recognition at the receiver. However, for the present, it has been decided to begin field testing without such additional signals. Meanwhile a subcommittee of Panel 14 has been set up to make a study of this particular problem.

BIBLIOGRAPHY

Specifications for Color TV Field Tests, *ELECTRONICS*, p 126, Jan. 1952.

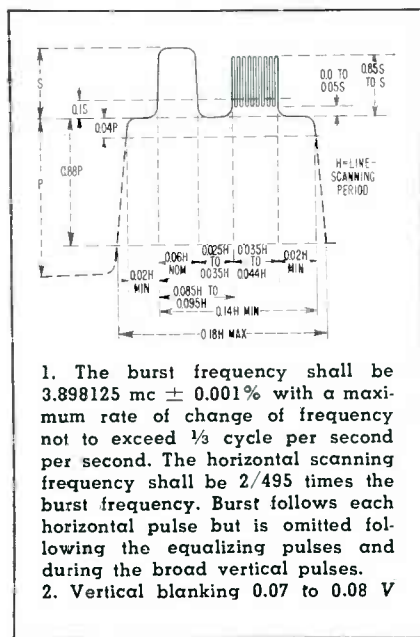

FIG. 2—Waveform characteristics recommended for field test

Vibrating-Plate

Viscosity indication directly on a meter with range from 0.1 to 100,000 and accuracy within \pm five percent are provided. Indefinitely large volumes down to 0.5 milliliter can be handled as long as a thin flat plate can be immersed in the liquid

VISCIOUS damping exerted by a liquid on a flat plate oscillating in the liquid is measured by an electromechanical transducer in the viscometer to be described.

A thin, flat plate oscillating in its own plane and immersed in a viscous liquid sets up shear waves in the liquid. The liquid exerts a retarding force against the motion of the plate.¹ This force comprises a resistive component which damps the motion and a reactive component which adds to the effective mass of the vibrating plate.

Both the resistive and reactive components are approximately proportional to $\sqrt{f\eta\rho}$ where f is the frequency of vibration, η is the coefficient of viscosity and ρ is the density of the liquid. If the damping force acting on the plate can be measured, the value of $\eta\rho$ can be deduced. This has been accomplished in the vibrating-plate viscometer by coupling the plate to a resonant mechanical system and comparing the amplitudes of vibration with and without the liquid damping while maintaining a constant driving force. Since the system is always operated at resonance, only the resistive component of the liquid loading need be considered.

Vibrating System

The vibrating plate is made of stainless steel or other suitable material 0.010-in. thick. It is essentially circular in shape, having a diameter of 0.200 in., and is mounted by means of a clamping block on the free end of a flat steel reed which is rigidly clamped at the opposite end. The reed is 0.010-in. thick, 0.200-in. wide and 0.875-in. long. It is set into vibration by an electromagnetic driving system of which it forms a part. The remainder of the driving sys-



Complete system of the vibrating-plate viscometer

tem comprises an L-shaped pole piece carrying a coil form and coil, an air gap between the pole piece and the free end of the reed and a steel block on which both the reed and the pole piece are supported. Vibratory motion of the reed causes the plate to execute linear oscillations in its own plane.

A ceramic barium-titanate block is mounted on each side of the steel reed for the purpose of measuring the amplitude of vibration of the reed. The rather remarkable electrical properties of barium titanate^{2,3} and its use in mechanoelectrical transducers^{4,5} have been discussed at length elsewhere. It is sufficient to say that motion of the reed causes a flexing of the barium titanate which, in turn, generates a piezoelectric voltage at electrodes on the surface of the barium titanate. This voltage is proportional to the amplitude of vibration.

While a vibrating system of this type has a theoretically infinite number of resonances or modes of

vibration, only the two lowest modes were found to be useful for the viscometer. The lower of these two resonances occurred in the neighborhood of 80 cycles, and the higher near 800 cycles. The 80-cycle resonance gave slightly greater sensitivity but the low-frequency vibrations were transmitted throughout the supporting structure of the viscometer so that the internal mechanical damping, and hence the amplitude of vibration of the reed, was influenced by the manner and the location in which the instrument was held. This made it difficult to secure completely reproducible measurements of viscosity. Troubles of this sort were not serious at 800 cycles, so the higher resonance was chosen for the design of the present device.

Several electrical accessories are necessary for the operation of the vibrating-plate viscometer. These include a d-c source for polarization of the electromagnetic driving system; an a-c source variable in fre-

provided by the R-C network in the grid circuit of V_1 .

With these phase corrections, the system oscillates at the mechanical resonance of the vibrating system near 800 cycles. Only when the vibrating plate is immersed in liquids of extremely high viscosity, 2,000 centipoises or greater, is the viscous damping so great as to prevent proper self-oscillation of the system. When it is desired to make viscosity measurements of highly viscous materials, therefore, an external oscillator must be used. This oscillator may be connected to terminals *I* and ground, shown in the circuit diagram, after removing the jumper between *I* and *X*.

The need for maintaining a constant driving force independent of the loading of the vibrating plate was mentioned previously. This requirement is met by converting the sinusoidal voltage from V_1 into a square-wave driving current whose amplitude depends only on circuit parameters and not upon the amplitude of motion of the reed. The magnitude of the driving current, along with the polarizing current, can be altered when desired by putting additional resistance in the cathode circuit of V_3 by means of the 5-position amplitude switch. The current through the driver coil can be measured by connecting a milliammeter between special terminals not shown.

A portion of the alternating voltage from V_6 is further amplified by V_7 and applied to the diode rectifier V_8 . Approximately 17 db of negative feedback around the two-stage amplifier of V_7 makes this portion of the circuit highly stable. The diode circuit and the microammeter form a conventional peak-reading vtvm. The level of the signal applied to the diode, and hence the meter deflection, can be altered by means of the METER RANGE switch and the FULL SCALE ADJ. potentiometer.

The remainder of the circuit of Fig. 1 constitutes a power supply. The two OD3 regulator tubes, V_4 and V_5 , maintain a constant B^+ for relatively large changes in line voltage.

Calibration and Use

After a warm-up period of a few minutes duration, the instrument is

readied for use by adjusting the gain of the vtvm circuit to give full-scale deflection of the meter with the reed and plate vibrating in air. Then, when the plate is immersed in a liquid, the meter reading is less than full scale and depends on the value of $\eta\rho$ of the liquid. By using a number of different liquids having known values of $\eta\rho$ a calibration chart for the instrument can be made. This calibration can be transferred to the face of the meter to permit direct indications of $\eta\rho$. In this calibration, η is in centipoises

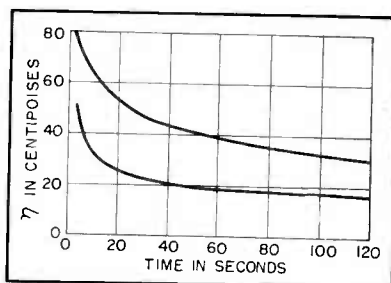

FIG. 2—Coefficient of viscosity as a function of time following immersion of the vibrating plate in thixotropic ferrite suspensions

and ρ is in grams per cubic centimeter. Increased precision is made possible by constructing the calibrated meter scale in three ranges corresponding to the three positions of METER RANGE switch shown in Fig. 1.

Performance

The vibrating-plate viscometer is capable of significant measurements from $\eta\rho = 0.1$ to $\eta\rho = 100,000$. This range encompasses acetone and alcohol at one end and cup grease and petrolatum at the other. Accuracies within ± 5 percent are possible. Higher precision can sometimes be obtained if only relative measurements between similar liquids are desired. Liquid samples having volumes as small as 0.5 milliliter may be used if they are held in a container shaped to give ample clearance for the vibrating plate. Indefinitely large volumes may be used as long as they offer a free surface into which the vibrating plate can be immersed.

Since the vibrating-plate viscometer gives a practically instantaneous meter indication, a measurement of viscosity may be made in a matter of seconds. On the other

hand, the instrument may be used to give a continuous indication as the viscosity of a liquid sample changes with time.

If desired, the rectified output of the diode which drives the indicating meter may be fed to an auxiliary amplifier and used to operate a recording galvanometer. As an example, a curve was automatically and continuously recorded in this way for a congealing gelatin solution whose viscosity changed from 10 to 200 centipoises over a period of 65 minutes.

The results of one application of the viscometer are presented in Fig. 2. The materials under test in this case were two ferrite suspensions such as are used in the slip casting of powdered-iron transformer cores. These suspensions are thixotropic, which means that their viscosities can be temporarily altered by stirring or shaking. Thus, any attempt to measure the viscosity causes the viscosity to change even while the measurement is being made. This is true regardless of the type of viscometer used.

Figure 2 shows how the viscosities of these two suspensions change with time following immersion of the vibrating plate. It is observed that after a sufficient time an equilibrium is reached and the viscosity becomes constant at some value depending on the size and the amplitude of vibration of the plate. Since only a comparison of the two suspensions was required in this experiment, the final values of viscosity gave a satisfactory result.

These examples illustrate some of the possibilities of the vibrating-plate viscometer. Others could be cited, but that is beyond the scope of the present article. It is apparent that in the vibrating-plate viscometer the application of electronic and electromechanical principles has once more afforded a new approach to an old field of measurement.

REFERENCES

- (1) Lord Rayleigh, "Theory of Sound," MacMillan and Co., London, 2, p 317, 1929.
- (2) A. von Hippel, Ferroelectricity, Domain Structure and Phase Transitions of Barium Titanate, *Rev. Mod. Phys.*, 22, p 221, 1950.
- (3) G. N. Howatt, J. W. Crownover and A. I. Dranetz, New Synthetic Piezoelectric Material, *ELECTRONICS*, p 97, Dec. 1948.
- (4) H. W. Koren, Application of Activated Ceramics to Transducers, *Jour. Acous. Soc. Am.*, 21, p 198, 1949.
- (5) L. Grant Hector and H. W. Koren, Ceramic Phonograph Pickup, *ELECTRONICS*, p 94, Dec. 1948.

Inexpensive Square-Wave Generator

A cathode-controlled multivibrator employing three tube envelopes gives square waves from 50 cps to 1 mc with only 2-percent tilt in the negative half. An additional circuit is described in which a pair of pentodes replaces cathode resistors to produce square waves

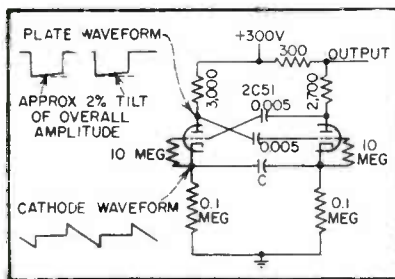

FIG. 1 — Single-tube (double-triode) square-wave oscillator circuit

By G. W. GRAY

RCA Laboratories Division
Princeton, N. J.

IN RECENT years there have been many articles in the literature concerning the use of square-wave techniques for testing amplifier circuits; however, no simple and inexpensive circuit for producing good-quality square waves is shown.

In producing such a generator it would appear that the use of clipper stages following a sine-wave oscillator is ruled out, since clipping at the bandwidth required for television testing requires several stages with carefully adjusted peaking coils and biasing. Thus a multivibrator-type square-wave generator is indicated. However, ordinary multivibrators show some serious shortcomings, the most serious of which is the grid current they draw.

This grid current is required since it is by rapidly charging a capacitor with grid current and then slowly letting it discharge that the frequency of oscillation is determined. Since the grid current is produced during the switching action it slows down the speed of operation of the circuit just the same

as shunt capacitance to ground would do. In other words, it matters very little whether current must be put into a shunt capacitance to cause a voltage change or whether a series capacitance must be charged with grid current. Thus, it is difficult to design ordinary multivibrators with fast enough switching actions to produce square waves suitable for testing television-type amplifiers.

Another effect of such grid current is the production of overshoot on the negative-going portion of the square wave at the plate. It is caused by grid current flow as the conducting tube momentarily draws more than zero bias current when its grid is driven positive. This overshoot must then be removed by a clipping stage since it appears much like the square-wave response of certain types of overcompensated amplifiers. A further shortcoming

of conventional multivibrators is that to change the frequency and keep the square wave symmetrical it is necessary to change two capacitors in the circuit. The switching problem is cumbersome because neither side of the capacitors is customarily grounded.

Cathode-controlled Multivibrator

A cathode-controlled multivibrator circuit has been developed that overcomes these difficulties. In the circuit shown in Fig. 1, each plate is coupled to the other tube's grid by a clamp circuit such that the positive peak of any recurrent waveform is clamped at zero bias. This coupling circuit must have a time constant long compared with the period of oscillation desired, but otherwise has no effect on the period. The gain from grid to plate of each tube is less than unity because, as will be shown, to pro-

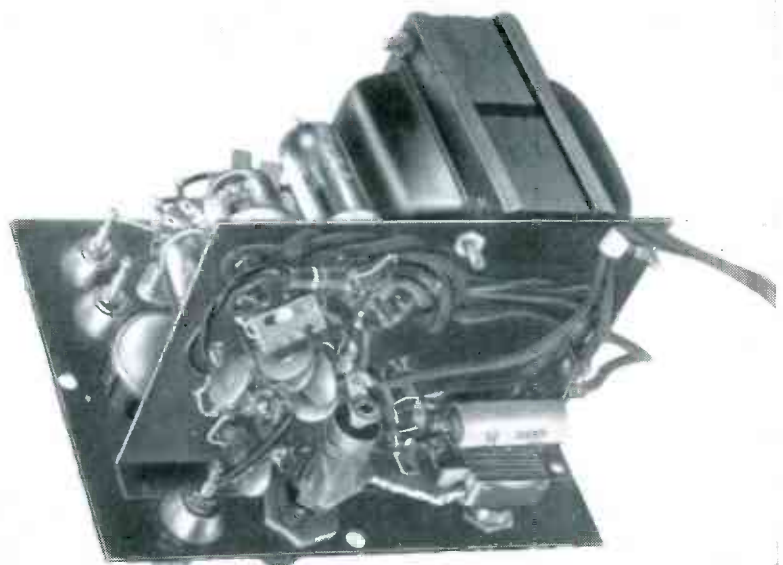

Under-chassis view shows simplicity of wiring and lack of crowding. Top deck is correspondingly simple

duce good-quality square waves it is necessary to have the cathode resistor considerably larger than the plate resistor.

If capacitor C between the cathodes is removed, the circuit will not oscillate because even though the phase of the feedback is regenerative the loop gain is less than unity. However, when capacitor C is added, another loop is completed as follows. If the cathode of one tube goes slightly negative, the signal is coupled to the other cathode by C , which in turn produces an amplified negative signal on its plate. This signal is coupled to the grid of the first tube, which drives the cathode even more negative. This loop may easily have enough gain to cause oscillation. In addition, the grid-plate loop aids the regeneration even though by itself it could not cause oscillation.

Figure 1 shows the plate and cathode voltage waveforms as a function of time. The grid waveform of each tube is exactly the same as that of the plate to which it is coupled since the coupling circuit has a long time constant. From these waveforms it can be seen that the period of oscillation is determined by capacitor C discharging through the cathode resistor of the cutoff tube until the cathode reaches a low enough voltage to start conducting. Now the regeneration of the circuit is such as to turn the cut-off tube on and the conducting tube off.

This switching can occur rapidly because there is no grid current drawn to slow down the switching action and there are two positive feedback loops both acting in the same direction. After the switch has occurred, the off tube is doubly cut off since its grid has been driven negative by the plate of the conducting tube and its cathode has been carried positive by capacitor C coupling the positive impulse from the cathode of the conducting tube. Capacitor C now discharges until the cathode of the cut-off tube becomes low enough to start conduction, at which time the circuit flips over and the same cycle repeats again.

As may be seen in the oscillogram of plate voltage, there is a slight amount of tilt in the negative half

of the square wave. This is due to a variation in the discharge current through capacitor C as the voltage varies across the cathode resistor of the cut-off tube. Since this current must come from the cathode of the conducting tube, the variation shows up as a slope in the voltage at that point. The grid of the conducting tube is at a fixed potential so the change in cathode potential that results from the change in current from the cathode results in an even greater slope on the plate voltage.

To minimize this effect the cathode resistor should be made as large as possible compared to the cathode self-impedance of the conducting tube. The major term in the cathode self-impedance of the conducting tube is a factor $(1/g_m) + (R_L/\mu)$, where g_m is tube transconductance, μ is amplification factor of tube and R_L is impedance in plate of tube.

If the cathode resistor is made too large the g_m of the tube is lowered excessively because the plate current of the tube is reduced too much and the ratio between cathode resistor and cathode self-impedance is reduced. Optimum cathode resistor size is indicated by minimum tilt in the negative half of the square wave. With a 2C51 tube it is possible to reduce the tilt to 2 percent of the overall square-wave amplitude while with a 12AT7 tube the tilt will be 5 percent.

Frequency Control

The frequency of this cathode-controlled multivibrator as a function of capacitor C is shown in Fig. 2. With the 10-megohm resistors from grid to cathode, the time constant of the coupling circuit is only $1/20$ second so that at about 60 cycles per second the curve departs from linearity. This range of linear relation between frequency and capacitance may be increased by removing the 10-megohm grid resistors since they are really not needed. Leakage through the cathode-coupling capacitors and gas current from the tube will both tend to make the grid go positive so that the circuit is effectively the same without the resistors except that the time constant is much longer. This effect is shown in Fig.

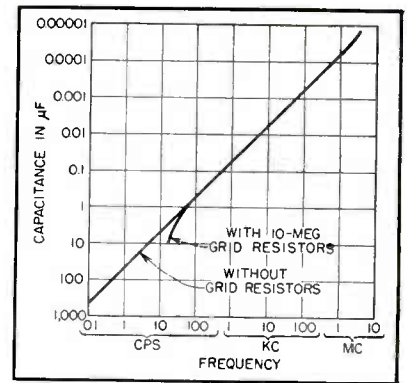

FIG. 2—Calibration of frequency versus capacitance of C in Fig. 1

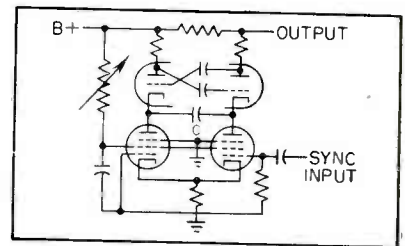

FIG. 3—Three-tube version of the square-wave oscillator in which pentodes replace cathode resistors. This circuit also provides for synchronizing

2 where, without the grid resistors, the curve extends linearly much further.

If it is necessary to have the negative half of the square wave flatter than is obtainable with the circuit of Fig. 1 the cathode resistors may be replaced by pentodes as shown in Fig. 3. With this circuit the discharging of the frequency-determining capacitor C must be a constant-current discharge since a pentode is a constant-current device. With the discharge current constant the plate current of the conducting tube is a constant and thus there is no tilt in the negative half of the output square wave.

This circuit has the additional advantages that: (1) a synchronizing pulse may be inserted on the grid of one of the pentodes; (2) changes in the plate current of the pentodes will produce small changes in frequency; (3) if the plate current of the pentodes is made unequal it is possible to make the square wave quite unsymmetrical so that the circuit becomes a pulse generator.

This cathode-controlled multivibrator circuit overcomes the difficulties inherent in more conventional circuits because no capacitor is required to change charge dur-

R-F Bursts Actuate

Technique for using simple gas diodes as radio-frequency actuated switches in storage, accumulator and other circuits of electronic computers. Bursts from pulsed r-f oscillators are applied to bands around diodes. Operating speeds up to 100,000 pps are feasible

By H. J. GEISLER

*International Business Machines Corp.
Poughkeepsie, New York*

THE GATE to be described is a special gas tube requiring for one of its inputs r-f energy supplied by a pulse-driven oscillator which usually is the common driver.

The required r-f energy to actuate the gate is coupled to the tube through the d-c electrodes and a single conducting band around the tube envelope. The cold open-circuit tube resistance is several megohms and the capacitance is less

than 1 μ f between electrodes and also between the band and the electrodes.

In the IBM-36 developmental tube, approximately 100 volts peak at 15 mc ionizes the gas filling. The oscillator provides 215 volts to assure good conduction in less than one microsecond provided initial electrons are present. With no r-f voltage present, the tube will not conduct until the d-c voltage is in

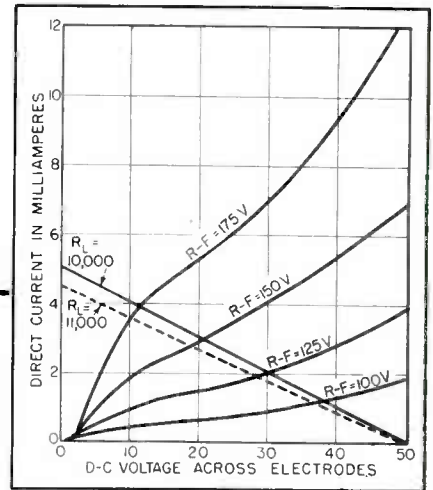

FIG. 1—Typical d-c voltage relations

excess of 100 volts. This d-c striking potential is reduced as r-f excitation is increased toward 100 volts.

With 15-mc r-f energy applied to the tube, the d-c voltage-current relation is as in Fig. 1. A 10,000-ohm load line is drawn to illustrate typical output voltages that can be obtained by r-f modulation when 50 volts d-c is applied between the electrodes. Although higher d-c voltages and load resistances will develop greater output voltages, the recovery of high resistance following the r-f burst is materially slowed down.

Total tube dissipation in excess of 3 watts, when applied over long periods of time, tends to decrease the conduction and increase the ignition requirements. For 215 volts of r-f excitation and 50 volts d-c through a 10,000-ohm resistive load applied continuously for 5,000 hours, the resulting power input of approximately 0.6 watt yields less than 10-percent change in conduction and ignition characteristics. Other tube structures have been built to handle more power where larger currents are required.

Pulse discrimination of the tube is improved by removing the r-f near the end of the last pulse to be transmitted by the tube, rather than stopping the r-f burst after the last required pulse and before the first

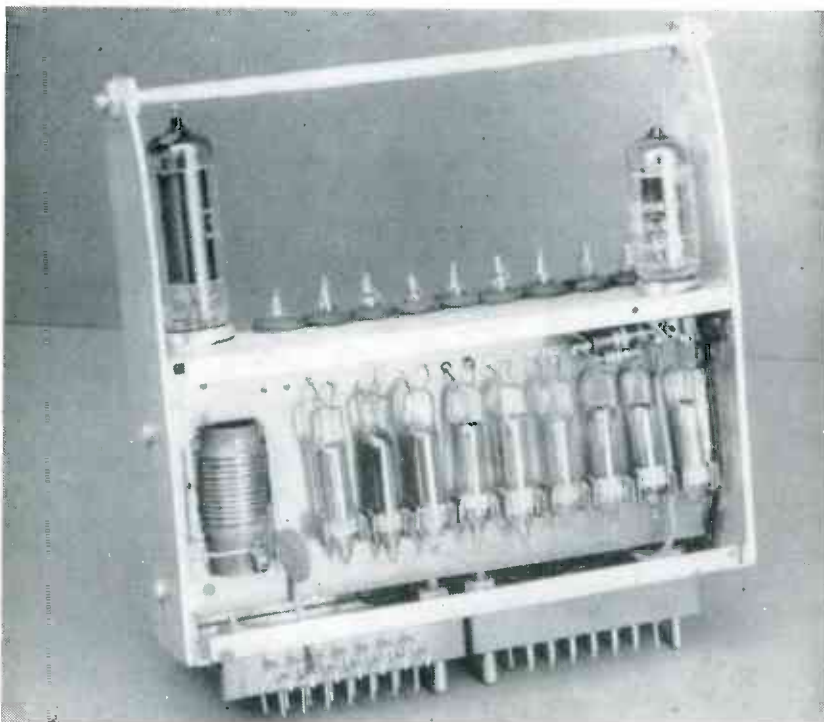

Assembly of nine special gas diodes having their outer metal bands connected in parallel for excitation by single 6AQ5 oscillator. Note use of fuse clips for making contact with metal bands. Standard NE-2 neon indicator diodes project up through grommets

Gas-Tube Switch

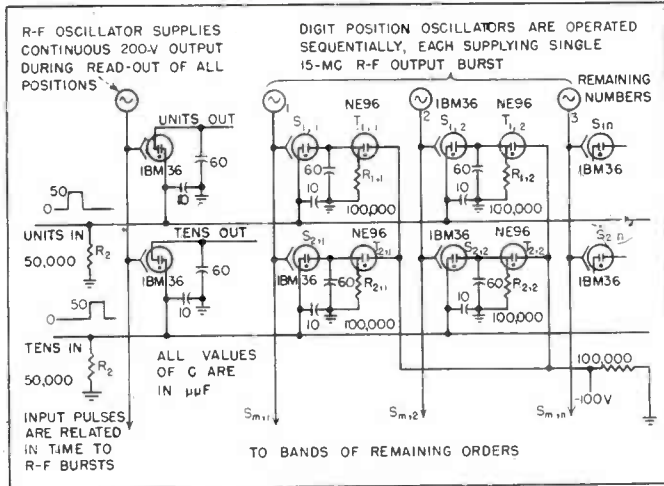

FIG. 2—Gas-tube storage system using r-f bursts to initiate switching

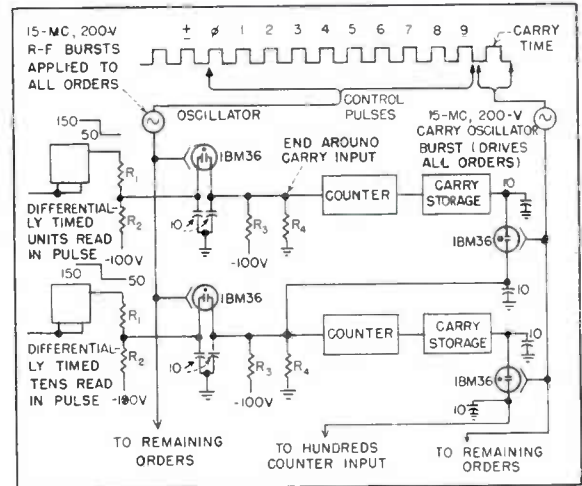

FIG. 3—Example of accumulator read-in circuit

unwanted pulse, and by keeping the circuit resistance small. Recovery to 0.5 meg under these conditions occurs in 10 μ sec.

The tube has the characteristic of being ionized by an r-f burst of less than the normal ionization value when such burst occurs shortly after a burst of normal value. Whenever the second burst follows the cessation of the normal actuating burst sooner than 200 microseconds, the amplitude of the second r-f burst must be less than half the normal ionization value, if ionization is not to occur.

Computer Storage Application

Gas tubes can be used for both storage (reading in) and reading-out elements, as shown in Fig. 2. Tubes $T_{1,1}$, $T_{1,2}$ to $T_{m,n}$ are ordinary glow lamps having about 40 volts between d-c ignition and sustaining values. A portion of this voltage difference will develop across any resistor $R_{1,1}$, $R_{1,2}$ to $R_{m,n}$, where m is the order and n the number position, upon ignition of its associated glow tube. The ignition is brought about by conduction of a time-positioned pulse at the time a particular digit oscillator is turned on.

Once conducting, the glow tube remains ignited until the voltage falls below the sustaining value. One oscillator is provided to actuate all tubes of each digit position.

Voltages may or may not be present across resistors R_1 to R_m at the particular time an oscillator is turned on. Only upon the simultaneous appearance of voltage across a resistor $R_{m,n}$ and an r-f burst will a particular tube $T_{m,n}$ be ignited.

During read-out, another oscillator excites a gas switch in any row R_m so that all orders are energized for the period of time required for the oscillators to sense all positions of the resistors $R_{m,n}$. This long-duration r-f burst can be held by an extra r-f actuated gas tube which acts as a holding contact on the oscillator positive drive until a pulse at "9" time turns it off. Any voltage that is found across any resistor $R_{m,n}$ of Fig. 2 is developed across the resistor R_m , whereupon the particular read-out switch passes the signal to its destination.

Accumulator Application

Another computer application for the r-f actuated gas tube is found in the accumulator read-in circuit of Fig. 3. One oscillator supplies nine r-f bursts to all columns of r-f actuated read-in switches by the usual gating methods. Resistors R_1 , R_2 , R_3 and R_4 are so chosen that voltage across the IBM 36 gas tube is zero unless a time-positioned signal has changed the level of the read-in storage device. The voltage level of the storage device is shown

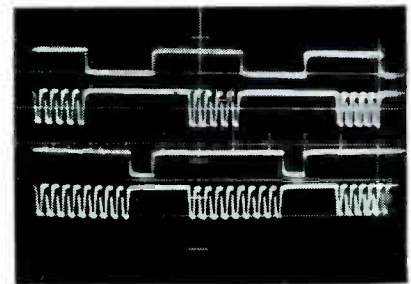

FIG. 4—Waveforms for reading in the numerals 5 and 9

to drop at the end of the fifth and ninth r-f burst in Fig. 4, indicating that after the fifth and ninth pulses the storage tube level was returned to the conditions where the voltage at the gas tube was zero. The carry signals are held in another storage element until a suitable point in the cycle is reached, at which time another oscillator simultaneously energizes another r-f actuated switch in each order, thereby passing any stored-carry signals to the input of the next-order accumulator.

R. L. Palmer, manager of the Poughkeepsie Laboratory of International Business Machines Corporation, initiated development and application of this tube in 1949. Since that time, many individuals have contributed in that direction. Credit is particularly due to A. L. Samuel, B. E. Toben and M. L. Wood for helpful suggestions during preparation of this paper.

More College Defense Research?

More than 400 qualified faculty members in 200 educational institutions are not now doing any defense research at all. Although 81 percent of the total college research time in electronics is directed towards defense, half the load is carried by only eight institutions

A SURVEY by the Engineering College Research Council shows that more than 400 faculty members who are considered qualified to perform *research in electronics* are not now doing studies of *any* kind. These scientists are at 200 educational institutions throughout the United States.

And although 81 percent of the total research time in electronics under way in American colleges and universities today is directed toward defense needs, eight institutions only are now responsible for more than half of this effort. Over 150 educational institutions, with 425 faculty members qualified to undertake research, today have no *defense* research assignments.

Research In General

This summary of electronics research in educational institutions comes from an analysis of figures in a national inventory of college and university research resources completed during mid-1951 by the Council's Committee on Relations with Military Research Agencies, at the request and with the active cooperation of the Research and Development Board in the Office of the Secretary of Defense.

In all, this extensive national inventory covered the special interests and activities of faculty and graduate students in all physical and engineering sciences at 750 colleges and universities in the United States. Nearly 25,000 faculty members, and an equal number of graduate students, were reported in all fields of physical and engineering sciences. Of these 20,000 are considered by their institutions

By **JOHN I. MATTILL**

*Secretary
Engineering College Research Council
Cambridge, Mass.*

to be qualified to perform research, but only 12,700 are now active in research. An average of 27 percent of the time of faculty members reported is spent on research activities, and on a national average 52 percent of this time is already spent on defense research—studies sponsored by military agencies or their industrial contractors.

Electronics Defense Research

The Council's figures show 1,119 faculty members and full-time senior research personnel in electronics. Of these, 1,032 are judged qualified to participate in research projects, and 625 of them are now engaged in research. This effort is

equivalent to that of a research staff of 387 working between 35 and 40 hours a week. Of these full-time equivalents, 314 would be engaged in defense projects for military agencies or their contractors. By this computation, electronic defense research amounts to about 81 percent of the total college and university effort in electronics in the United States today.

Junior Workers

A total of 1,107 graduate students and assistants in electronics were reported by the survey, equivalent to the full-time work of 558 junior research staff members.

More than 200 colleges and universities reported one or more staff members interested in and qualified for research in at least one field of electronics, and nearly 100 schools indicated a broad range of interests in the field.

The Unequal Load

Nevertheless, the University of Michigan, New York University, University of Pennsylvania, Cornell University, Massachusetts Institute of Technology, Georgia Institute of Technology, Pennsylvania State College, and University of Florida account for more than half of the total defense research in electronics in colleges and universities, with an equivalent of 157 full-time senior research staff members.

Yet, these same eight institutions have only 259 faculty members and senior research personnel in electronics—about a quarter of those available throughout the nation. In the "big eight" nearly two-thirds of the total teaching and

American Society for Engineering Education Engineering College Research Council

*Dr. Gerald A. Rosselot, Chairman,
Georgia Institute of Technology*

*Committee on Relations with
Military Research Agencies*

*Dean A. F. Spilhaus, Chairman,
University of Minnesota*

*Dr. A. P. Colburn,
University of Delaware*

*Dean W. L. Everitt,
University of Illinois*

*Prof. F. B. Farquharson,
University of Washington*

*Prof. C. W. Good,
University of Michigan*

*Dr. Paul E. Klopsteg,
Northwestern University*

*Dr. James S. Owens,
Ohio State University*

*Dr. J. R. Van Pelt,
Montana School of Mines*

*Dr. Eric A. Walker,
Pennsylvania State College*

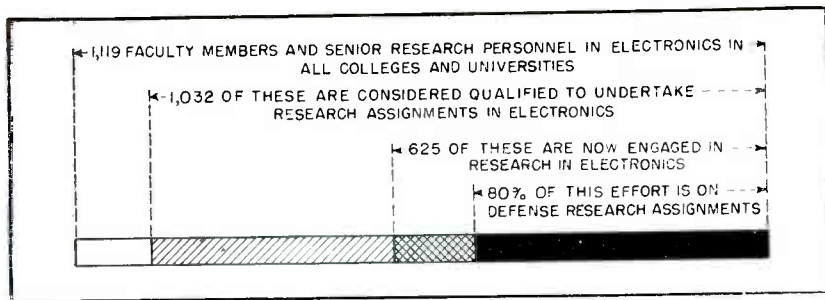

Faculty and senior research personnel reported available for work in electronics and the number of individuals actually so engaged

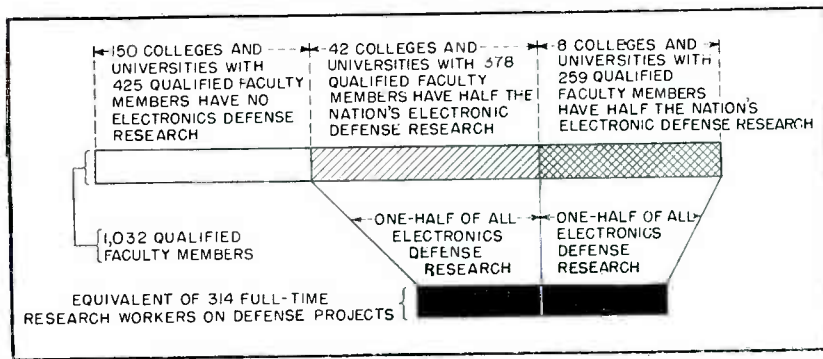

Qualified electronics research personnel, their disposition in the colleges, with their equivalent full-time contribution lower right

Field of Competence	Number of Institutions
Antennas and wave propagation	106
Communication theory	133
Components	62
Countermeasures	24
Electroacoustics	61
Electromagnetic waves	86
Electronic circuits and theory	201
Electronic computers	54
Electronic control equipment	125
Electron theory	108
Electron tubes	114
Microwave circuits	101
Miniature and printed circuits	19
Navigation aids and direction finding	41
Radar	97
Radio communication	147
Radio interference	57
Radiosonde	20
Speech security and scrambling	17
Television	50

Table I—Research Specialties in Electronics

research effort in electronics is devoted to defense research, compared to slightly more than one-quarter in all colleges and universities.

Of the 1,032 senior faculty and research staff members qualified to perform research in electronics in colleges and universities, only 625—a little more than half—are now engaged in any research work in that field. This leaves at least 400 faculty members not now active in research who are presumably available for research assignments. If they undertake research on only a quarter-time basis, the equivalent of 100 more full-time research scientists is added to the nation's research force, an increase of 32% in one of the most critically short areas of today's effort.

Research Potential

Widely diversified capabilities for increased service to military agencies and industry are available. In connection with the Council's inventory, institutions were asked to indicate special fields of electronics in which one or more staff members were interested and competent in research. The answers are summarized in Table I.

This list does not imply equal competence on the part of each educational institution indicated. Po-

tential contractors and sponsors must still select with care institutions to receive contracts for specific projects. But it does indicate that vastly wider resources are available than have thus far been tapped—and there are important reasons for pressing into service less-experienced scientists who may indeed turn in a performance quite as creditable as that from the more familiar sources contractors would choose to approach first.

Special Equipment

Many research projects in electronics require specialized equipment not available at all schools. In general, however, lack of qualified personnel is the principal bottleneck in the current necessary expansion of research. If competent manpower is available, necessary equipment can probably be supplied to the potential research workers.

Nevertheless, a partial inventory of specialized equipment found only uncommonly at educational institutions was attempted in the belief that the availability of such equipment might be an important factor in the location of research there. Thus, such electronic equipment as computers and analyzers, correlators, electron microscopes, electrostatic generators, linear accel-

erators and vocoders were listed by institutions where available.

Decentralizing Research

Other, secondary benefits may result from the decentralization of assigning research to many schools not now involved. New research activities will, if properly organized, contribute to strengthening the educational programs with which they are associated. This, in turn, will assure an increasing supply of well-trained students to help fill the critical manpower needs now facing the electronics industry.

Another important gain may be realized by increasing the ratio of graduate students to full-time senior faculty and staff on research projects in those schools where graduate education is under way. This should have a similar effect of increasing the future supply of electronics manpower.

The full statistical report of the survey project, entitled "University Research Potential", identifies all schools reporting personnel, competencies, and equipment. Copies are available from the Secretary of the Engineering College Research Council at Room 7-204, 77 Massachusetts Ave., Cambridge 39, Mass., at \$1.00 each.

CONCENTRIC-LINES

By **EDWARD E. HARRIES** and **MADISON CAWEIN**

Sales Manager, TV Tuner Div.
P. E. Mallory and Co., Inc.
Indianapolis, Indiana

Consultant

DESIGN of a tuner for the uhf television bands presents a number of problems. In addition to those involved in tuning the complete frequency range, it is necessary to consider oscillator tracking for different i-f frequencies, stray circuit parameters and their effects, and resetability of contact arrangements.

Metal strips arranged in a noninductive, concentric path are employed as dual-inductor elements in the Mallory uhf Inductuner. The edge-mounted strips provide the required inductance range in 270 degrees of rotation. The strips are pressed into molded grooves in a mica-filled phenolic base material. Terminals for each tuning element protrude from the bottom of the tuner and one, two, three, or four sections can be assembled in a single case.

The preselector tuning elements are shaped differently from each other and from the oscillator tuning elements to provide good uhf tracking. Typical frequency versus dial-rotation curves for the r-f and oscillator sections with an intermediate frequency of 82 megacycles (channel 5 or 6) are shown in Fig. 1.

Best performance is obtained by

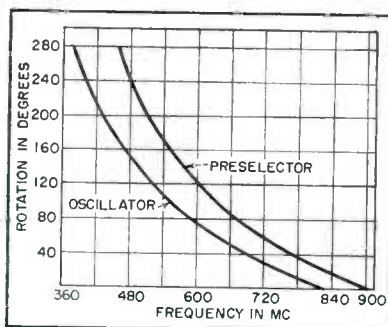
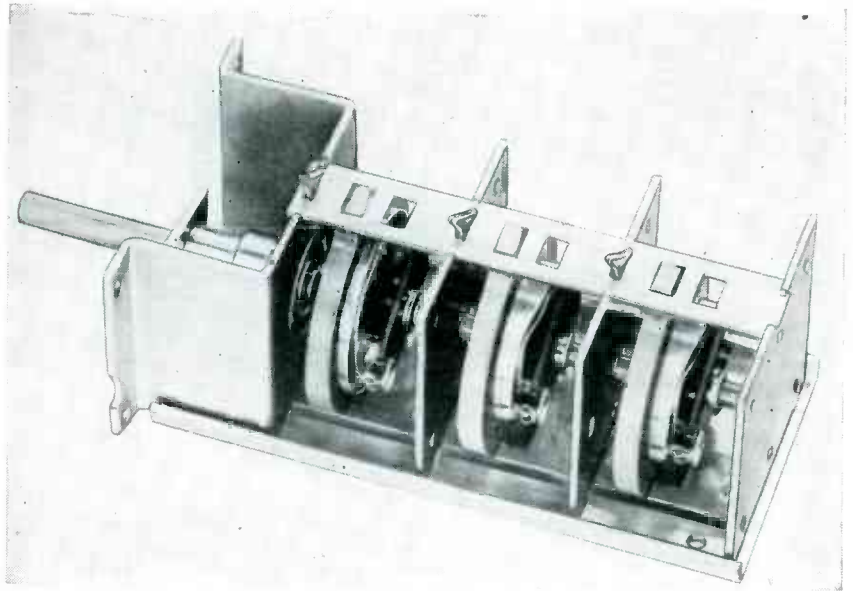

FIG. 1—Tuning curves for producing an i-f of 82 mc



Three-section tuner for tv channels 14 to 83

using an unbalanced, 300-ohm input circuit. A split-capacitor arrangement is used for antenna coupling. A 300-ohm, balanced-input circuit is under test, but has not been finalized as yet (indicated in Fig. 4).

The input-circuit equivalent, Fig. 2, indicates a preferred circuit arrangement for preselector tuning elements. This arrangement represents an impedance step-up from the antenna to match the tuned circuit impedance. This step-up is several fold, depending on the relative values of C_a and C_i (approximately 2.2-to-1 capacitance ratio, or 5-to-1 impedance ratio).

The tuning elements in the preselector circuit cover the tuning range of the uhf band (10-mc overtravel at each end) with an external tank capacitance of approximately $1 \mu\text{f}$. The oscillator tuning element will cover the required range for a

converter (oscillator frequency below preselector frequency) with an external tank capacitance approximately equal to the grid-plate capacitance of the 6AF4, approximately $1.5 \mu\text{f}$ external.

The circuit shown in Fig. 3 illustrates one preferred method of using the tuner element. As the element is relatively symmetrical in structure, both terminals may be operated in a balanced condition above ground. One advantage of this connection is the provision for placing the a-c potential of the variable inductance coil center at ground. Another advantage is that of being able to couple into the circuit, at tapped-down points, from two relatively isolated circuits, as in an antenna circuit or a mixer circuit.

The preselector tuning elements, when connected to ground as shown in Fig. 3, exhibit a suck-out resonance at approximately 370 mc. If

TUNE UHF CHANNELS

Continuous coverage of television channels 14 to 83 is provided by edge-mounted metal strips and movable shorting bars for tuning each stage of a receiver front end. Design and circuit analysis includes complete converter using the elements

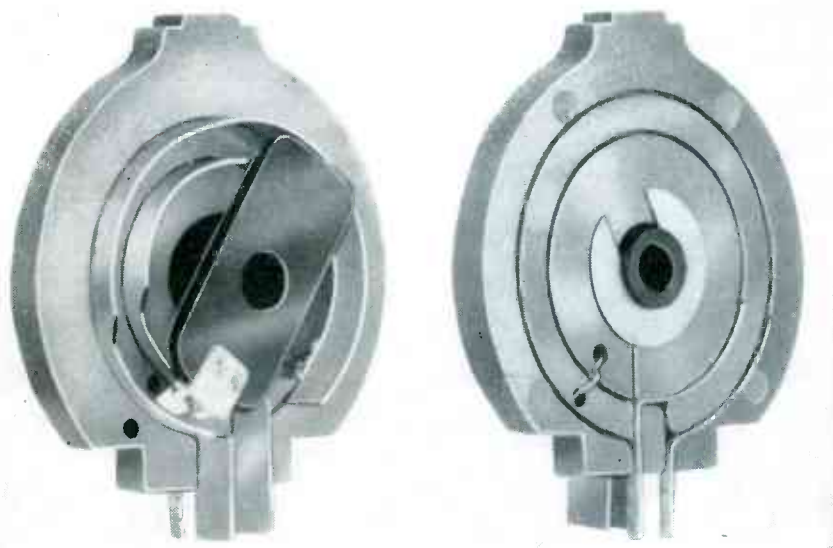

Front and rear views of antenna-coupling section

the magnitudes of the two capacitors are unbalanced (made slightly different in opposite directions), two spurious resonances will occur at frequencies slightly lower and higher than 370 mc. If the value of each C should be decreased to 1.2 $\mu\text{p.f.}$, the spurious resonance will become high enough to cause a loss of gain at the low end of the uhf band.

It is advisable to provide a physical ground at G_2 . In practice, grounds G_1 and G_2 can be inches apart on the chassis. The purpose of this ground is to short-circuit any low-frequency interference which may be present and to reduce oscillator radiation.

Suck-Outs

When operating the oscillator above 760 mc, it is necessary to connect the inner, concentric conductor back on itself, otherwise, an undesirable resonance (suck-out) occurs at approximately 780 mc. This

suck-out will reduce or kill the oscillator output above 760 megacycles in some types of oscillator circuits.

A wide-strip, oscillator tuning element is available for applications above 760 megacycles. In these elements, the suck-out occurs above 900 mc.

A 3-section tuner is used in the converter circuit of Fig. 4 to provide coverage of channels 14 to 83. The oscillator operates on the low side of the carrier to prevent inversion of the video and audio carriers, and thus enables the converter to be used with a conventional vhf receiver.

The circuit consists of a preselector, crystal mixer and oscillator, followed by an i-f stage. The input impedance is 300 ohms nominal, shown as a balanced line, and the output impedance is 75 to 300 ohms. The gain of this converter is approximately 1.0 when used with the 300-ohm output connection and

a 300-ohm receiver input.

The preselector utilizes two tuning elements for double-tuned selectivity and an impedance match ahead of the mixer. Each tuning element has spurious resonance below the band at approximately 370 megacycles. A single oscillator-tuning element, which has spurious resonance above 900 megacycles, is employed.

In this case the three tuning elements are all different. The input element provides balanced coupling to the antenna and its shape differs from that of the second preselector tuning element. Both elements are shaped to track the oscillator.

Input Coupling

The antenna-coupling means, shown in Fig. 2, represents a com-

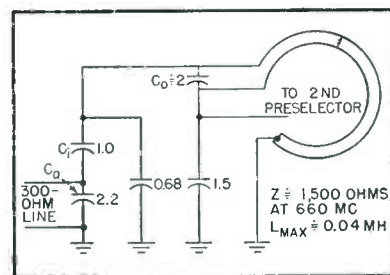

FIG. 2—Equivalent input circuit employing impedance step-up from antenna

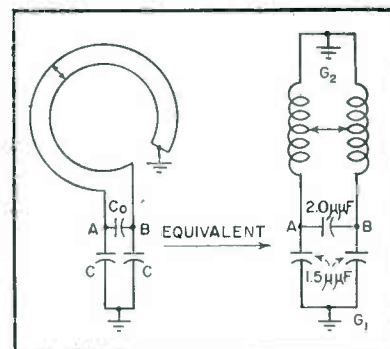

FIG. 3—Preselector circuit showing balanced condition

promise between energy transfer (from various types of antennas or lines), alignment problems, oscillator radiation and noise figure.

The band-pass coupling arrangement of Fig. 4 can be represented by C_1 and L_1 , and contains an automatic adjustment of bandwidth across the range of the converter. When properly aligned, it is possible to maintain tv channel band-

widths in the uhf range at approximately 10 to 14 megacycles. The coupling between circuits provided is

$$k = \frac{1}{3 + (1 - r^2) C/C_1}$$

The symbol, $r = f/f_1$, is the ratio of selector resonance to the resonance of L_1C_1 . The value of C_1 should be adjusted for a bandwidth of 12 mc at 700 megacycles, while L_1 is

a few centimeters long and probably has an inductance of about 30 millimicrohenries. Probably C_1 is of the order of $\frac{1}{2}$ μ f. Thus, C_1L_1 resonates near 1,500 megacycles, and k increases at high frequencies to compensate partially for increased power factor, thus keeping peak separation (which is equal to $f\sqrt{k^2 - p^2}$) relatively constant.

In the mixer circuit shown in Fig. 4, the input coupling circuit resonates at approximately 350 mc. This circuit may exhibit a second resonance near 900 megacycles.

The resistance component of the mixer impedance is estimated to be 1,000 ohms, based on injection of approximately 1 mw of oscillator power. Thus, the Q of the mixer circuit is probably somewhat less than 10 at 900 mc.

The oscillator tuning section covers a range from 378 to 828 mc for an i-f of 82 mc.

Oscillator Analysis

The oscillator equivalent circuit is shown as a reactance network in Fig. 5. The circulating current in the tank circuit, composed of the reactance arms of the network produces out-of-phase potentials between grid and plate.

The cathode is tapped in near a null-point of the network due to approximate balance between total C_p and C_g , and R_p and R_g . Consequently, the reaction of the cathode and heater circuits on the oscillator tank circuit is minimized. Value R_p is made up of plate resistance in parallel with isolating resistance. The grid leak, in parallel with the transit-time conductance constitutes R_g , which changes with frequency.

Mixer excitation is derived from coupling to the cathode through the heater-cathode capacitance of the tube (effective value of C_{hk} is 2.7 μ f approx for the 6AF4). Thus, the preselector circuits coupled to the mixer have a minimum reaction on the oscillator. The oscillator injection is relatively uniform across the band. The reactance of L_n increases with frequency, and tends to increase the output as the transit-time loading of the input circuit increases. This action offsets the general tendency toward reduction in oscillator voltage due to

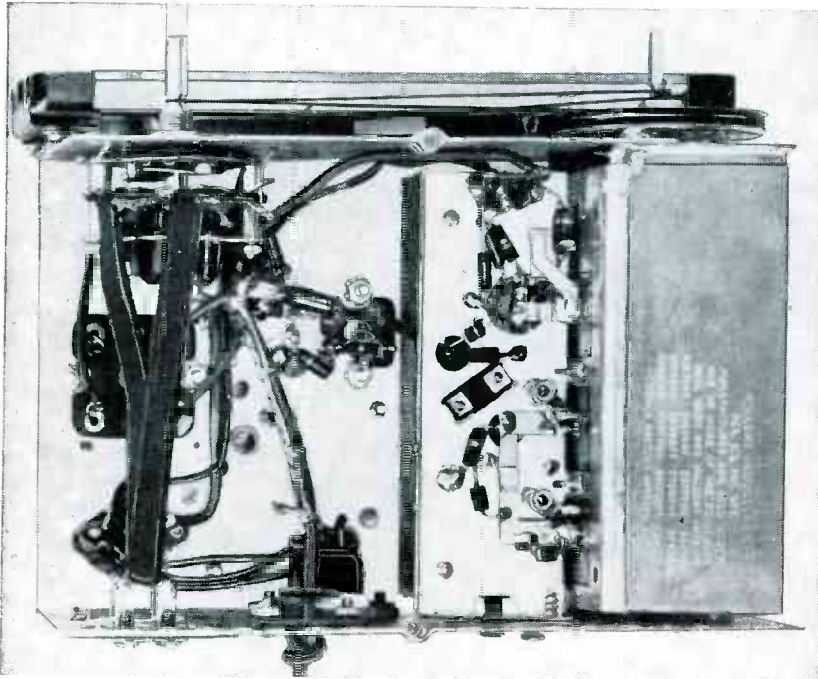

Bottom view of converter chassis shows critical wiring arrangement necessary for low-inductance leads at these frequencies

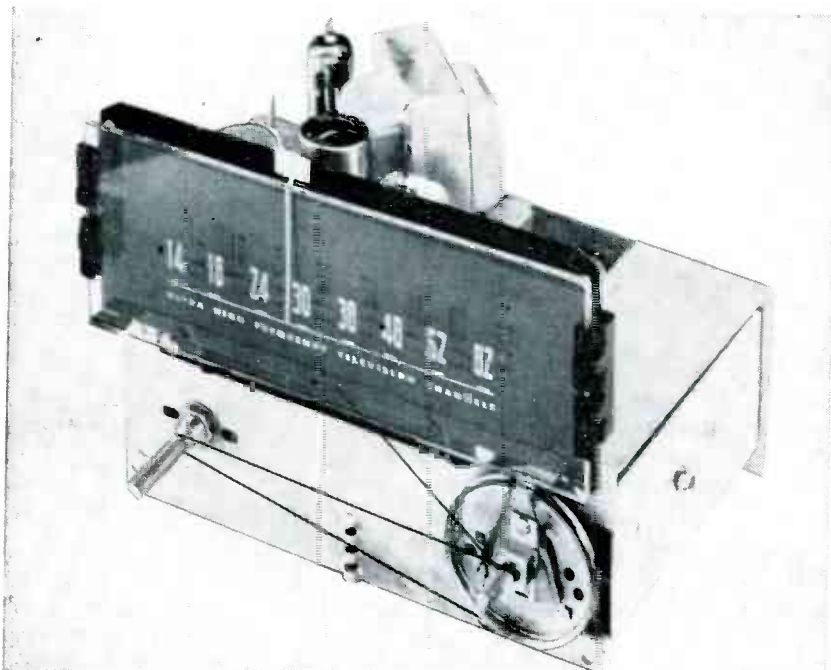

Complete converter covers the range from 470 to 890 mc

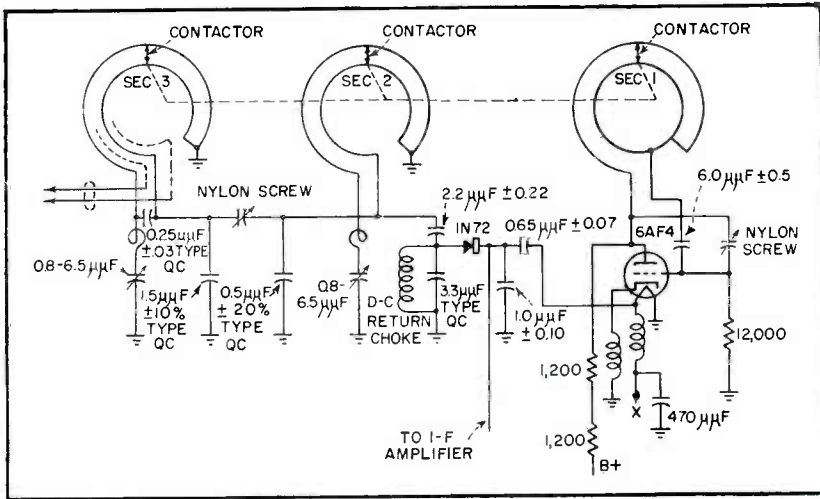

FIG. 4—Complete circuit of converter with three-circuit tuner

decrease in R_p at higher frequencies, while R_p remains relatively unaffected.

Although the ideal ratio of total grid-circuit capacitance to total plate-circuit capacitance is not maintained in this network (ideal $C_p/G_p = \mu/2 = 8$), the tendency toward reduced oscillations at the higher frequencies, due to transit-time phase-shift, is offset.

Referring to Fig. 6, voltage E_p lags the tank current I by 90 degrees, and voltage E_g would lead by 90 degrees if the power factors of both C_p and C_g were small. The power factor of C_p decreases with frequency, but the power factor of C_g increases with frequency ($p = 1/RC\omega$) because R_p varies inversely with the square of frequency. Thus, E_g tends to lead by more than 90 deg as the frequency increases and reaches its maximum before it should. This phase lead offsets the increasing transit-time delay between maximum E_p and maximum E_g as the frequency increases.

The compensation of transit-time phase shift is necessary at high frequencies to maintain oscillations. This compensation will not occur for values of C_g that are comparatively greater than C_p , because the power factor of the grid circuit would then be proportionally smaller (current and voltage would be substantially 90 deg out of phase) and the grid maximum would occur too late for transference-in-time to the plate.

Oscillator drift has been minimized by the location of parts and

by thermal isolation from heat contributed by the i-f and power-supply tubes. For intercarrier audio sets, the converter stabilizes during normal set warm-up time (approximately one minute). For split-audio receivers, a 3 to 5 minute warm-up may be required.

I-F Amplifier

The well-known cascode circuit is used as the i-f amplifier. This requires neutralization to maintain a good noise figure at high values of i-f frequency. The circuit arrangement takes account of the distributed tube constants. Though the circuit is inherently good, from the standpoint of noise figure, the transit-time loading of the first-tube grid represents a noise source having an effective noise-temperature ratio (to room temperature) of $t = 5$ (corresponding to $t = 1, 2, 3$, or higher for a crystal). The transit-time conductance g_t is inversely proportional to the square of the frequency up to 200 megacycles. For the 6BQ7, the transit-time loading is approximately 10,000 ohms at 82 megacycles. This constitutes a noise generator between grid and cathode.

Noise Figure

It can be shown that the principal noise sources in an amplifier are related to an input network of equivalent resistors (See Fig. 7) or conductances, whose temperatures may not be all the same. Further, the available noise power output of conductances in parallel, all

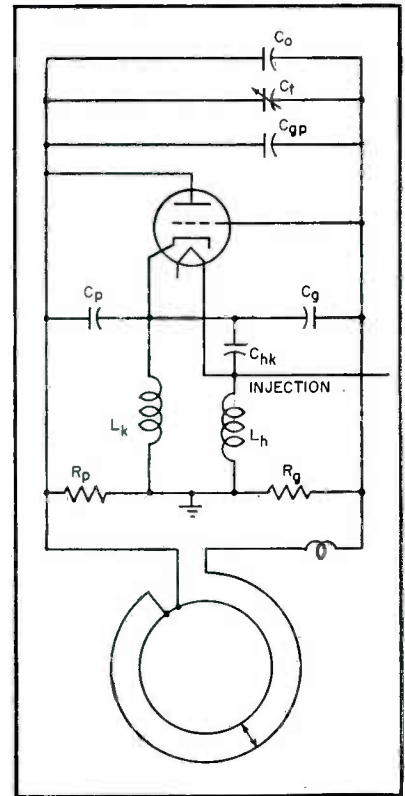

FIG. 5—Reactance network equivalent of oscillator

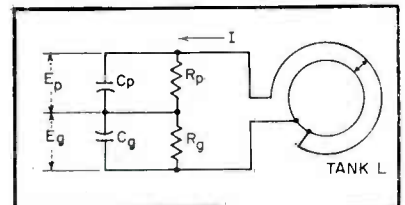

FIG. 6—Analysis of compensation for oscillator transit-time phase shift

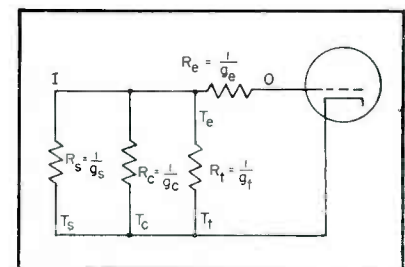

FIG. 7—Equivalent resistances and conductance of amplifier

at the same temperature T , is equal to KTB over a bandwidth B . This is identical to the available output from any resistor at temperature T , regardless of its magnitude.

Each resistor contributes only a portion of the total noise power. Due to the presence of the others, only a portion of KTB is available from each. This portion depends di-

Magnetic Modulators

Conversion of low-level, low-frequency or d-c signals to a-c signals capable of being amplified by conventional means is accomplished by magnetic-amplifier-type device that combines high efficiency and reliability with extreme ruggedness.

By E. P. FELCH, V. E. LEGG and F. G. MERRILL

*Bell Telephone Laboratories
Murray Hill, New Jersey*

Amplification of small direct and subaudio a-c signals has always presented problems such as high noise and poor zero-stability. Many ingenious methods for circumventing these difficulties have been proposed and used. Most involve the conversion of the signals to be measured to a-c signals of frequencies that can be readily amplified by conventional means.

This paper describes such a method employing a magnetic modulator, or magnetor.

A magnetor is a low-level signal converter employing magnetic modulation. While magnetors fall in the general category of magnetic amplifiers, they correspond functionally to the modulators, sometimes called mixers or converters, in the electron-tube art. Their conversion efficiency, low noise level, and linearity adapt them particularly well to applications requiring low-level signal conversion for which they are ordinarily used.

Their frequency response extends downward to direct current. The freedom from moving parts and critical balances common to other types of converters not only permits extended frequency response but also achieves long life and freedom from maintenance.

The principles underlying the operation of magnetors are far from new. Extensive studies of the behavior of high-permeability magnetic materials as low-level modulators have been carried out as indicated by the bibliography at the end of this article.

Principles of Operation

In its simplest form, as shown in Fig. 1, a magnetor consists of a core of magnetic material surrounded by a single winding. A pure sinusoidal current of exciting frequency f is applied to the winding and increased in value until the core is nearly saturated during a portion of every half cycle. If

the voltage across the coil is analyzed, it will be found to consist of the exciting frequency and odd harmonics thereof. No even harmonics of the exciting frequency will be present, in the ideal case. However, if a direct-current signal is super-imposed on the alternating current in the winding, the second and higher even harmonics of the exciting frequency will appear across the winding.

This behavior is a consequence of the perfect symmetry of the normal $B-H$ curves, which produces corresponding symmetry of the output voltage wave. This symmetry can be measurably upset by unidirectional flux which may be many orders of magnitude less than the saturation flux value.

If the amplitude of the second harmonic output voltage is compared with the d-c signal current, a linear relationship will be found to exist over a range of at least 300 to 1, or 50 db, limited by noise and by saturation at the lower and upper extremes of the range, respectively.

Polarity, Phase and Sidebands

Direct-current signal inputs of opposite polarities produce second-harmonic output voltages differing in phase by 180 degrees. In other

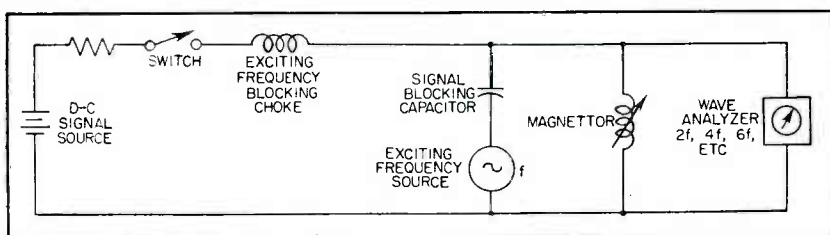

FIG. 1—Basic circuit shows magnetor (magnetic modulator) being used to convert d-c signal to proportional a-c signal capable of being amplified by conventional means



FIG. 2—Straight tubular core magnetor requires considerable shielding to eliminate spurious signals from ambient fields. Permalloy sheet at left is rolled into cylinder and placed in 2-in-long methacrylate pool

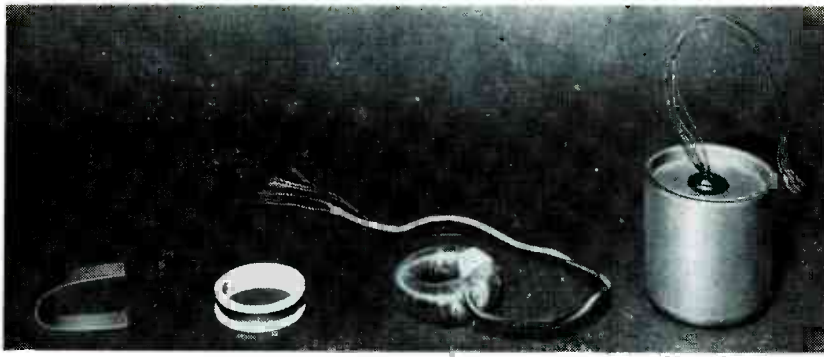

FIG. 3—Toroidal core configuration reduces shielding requirements. One-mil thick strip (left) is wound around 1¼-inch ceramic spool

words, the phase of the second-harmonic output voltage follows the polarity of the d-c input signal. This is an exceedingly useful property. By employing a phase-sensitive rectifier for reconversion of the second harmonic voltage to direct current, the polarity of the input signal may be recovered in the output. The frequency and wave shape of a-c signal inputs can be reproduced in the output provided that demodulation is accomplished in a phase-sensitive demodulator.

If a simple rectifier or demodulator is employed the input-output relationships are quite different. For direct-current signal inputs of either polarity, the rectified output is d-c of a single polarity.

For a-c signal inputs the principal demodulator output consists of the second harmonic of the a-c input signal. The magnetor output for an a-c signal input containing no d-c component comprises two sidebands of frequencies numerically equal to the sum and difference, respectively, of the second harmonic of the exciting frequency and the input signal frequency. Since there is no second harmonic generated in this case the signal frequency to sideband relationship is like that associated with suppressed-carrier modulation systems.

The degree and permanence of carrier suppression obtainable with magnetors significantly exceeds that of other types of modulators because of the almost perfect inherent symmetry of the B - H characteristic, upon which this balance depends. This is in contrast with the usual situation where carrier balance is a function of the identity of pairs of nonlinear circuit ele-

ments of indifferent stability.

Superposition of a d-c input signal restores the second-harmonic carrier and produces a relationship analogous to that encountered in conventional amplitude modulation.

The amplitude, phase and sideband relationships mentioned above hold for all of the higher even harmonics as well as for the second. This fact has been exploited in some magnetometers.

The performance of magnetors is dependent upon their physical design and upon the circuit in which they are used. Characteristics of principal interest include transimpedance, noise level, linearity, frequency response and input impedance. Transimpedance Z_m is a term given to the derivative of the open circuit second harmonic output voltage with respect to the input current

$$Z_m = \frac{dE_{2f}}{dI} = \frac{\mu' N^2 A f}{l} \times 10^{-7}$$

where μ' is the effective permeability (approaches permeability of core material for toroidal or other closed coil structure), N the number of turns, A the cross-sectional area of the core in square centimeters, f the excitation frequency in cps and l the length of the winding in centimeters.

Core Materials

The selection of core material affects both the transimpedance and the excitation requirements. Desirable characteristics are high permeability, for maximum transimpedance; low coercive force, for minimum loss of excitation power through hysteresis; and ease of producing saturation at relatively

low magnetizing forces.

These properties are combined to a highly satisfactory degree in 4-79 Molybdenum-Permalloy.

The thickness of metallic core materials affects the eddy current losses—the thinner the material, the lower the losses.

The design of the core structure influences two aspects of magnetor performance to a marked degree—transimpedance and noise level. Desirable characteristics are high μ' for maximum transimpedance, freedom from mechanical strain of the core material for minimum noise level and zero offset, and rigidity and mechanical stability for minimum noise level. Two basic core structures have been employed in the simple circuit of Fig. 1—the straight tubular type and the toroidal form.

Tubular Cores

The straight tubular core magnetor is shown in Fig. 2. These perform excellently as d-c to a-c converters, if adequate shielding is provided to eliminate spurious signals from ambient magnetic fields, such as that of the earth or of neighboring electrical machinery.

As shown in Fig. 2 this core consists of a strip of 4-79 Molybdenum-Permalloy one mil thick and 3/8 inch wide rolled into a tube about 1/10 inch in diameter and 1½ inches long. The rolled core has barely more than one convolution. After it is annealed it is slipped over a glass tube, which is then inserted in a Lucite spool as shown.

The tubular form of core possesses a number of advantages over other straight-core structures such as flat strips and wires. Inherent rigidity and adaptability to strain-free mounting are perhaps its outstanding virtues. In any magnetor core structure strains of a permanent or a transient nature give rise to zero offset and noise, respectively.

In a straight core or, for that matter, in any core structure with a large air-gap, the effective permeability μ' is a function of the core geometry as well as of the permeability of the magnetic material itself. In a solid cylindrical core the value of μ' is particularly de-

pendent upon the length-to-diameter ratio. It is greater for long slender cores. For tubular cores the effective diameter is not the outside diameter but it approximates more closely that of a solid cylinder containing the same amount of material, and having the same length.

It is difficult to be rigorous concerning values of μ' for cores of various dimensions. However, Table I, which is based upon experimental data, illustrates the influence of core dimensions upon the value of μ' . All of these cores were made from 4-79 Mo-permalloy tape 1 mil thick, and contained one or more convolutions to make up the areas indicated. A figure of merit is shown in the last column. This is simply the product of μ' and the area of core material, as they both appear in the formula for transimpedance.

Despite the approximate nature of these data it may be concluded therefrom that for a tubular core magnetor the transimpedance is approximately proportional to the length of the core, and is influenced to a minor degree by the amount of material in the core. Since, however, the required exciting volt-amperes is a function of the area of core material it appears advantageous to employ cores containing the minimum amount of material.

The effective output impedance of straight tubular core magnetors is affected principally by the value of μ' , and secondarily by the area of the core. These effects also favor cores of smallest practicable cross-section.

Toroidal Cores

Magnetors with toroidal cores, for applications not involving measurements of the earth's field, have proven attractive from two standpoints. The problem of shielding the core from earth's field is reduced by a factor of about 1,000 compared with those having straight cores, and the transimpedance which can be realized is increased by at least an order of magnitude for structures utilizing approximately equal volumes. The latter advantage arises from the fact that the value of μ' approaches closely the permeability of the ma-

terial itself and is practically independent of core dimensions. The only drawback to this is that the permeability of the material may be somewhat less stable than that of μ' for tubular cores. This provides a partial explanation for the slightly higher residual noise level observed in toroidal core magnetors.

The transimpedance and the exciting power in this case are both approximately proportional to the cross-sectional area of core material. The effective output impedance has been found to be almost proportional to core area. Hence, both the open-circuit output voltage and the output power into a matched load for a given d-c input current are linearly proportional to the core area.

Two general types of toroidal cores have been found useful. One consists of a pile-up of permalloy washers insulated from each other and enclosed in an annular box of rigid material. The box insulates the core material from mechanical strains. Another toroidal core design which lends itself well to manufacture by more or less conventional methods is illustrated in Fig. 3. The ends of the tape are spot welded and the assembly is annealed as a unit. The coil winding is applied directly to the ceramic form. The core illustrated consists of a single turn of tape. The core area may be increased as desired by applying more turns of tape. Values of μ' determined ex-

perimentally for this type of structure are in the order of 30,000.

Windings

From the standpoint of signal input the significant parameters of the winding are resistance and N/l , the turns per unit length of the winding. Minimizing resistance and maximizing N/l increase the voltage and current sensitivities, respectively. For a-c signal inputs the impedance of the winding is important, and this is proportional to N^2 , the square of the number of turns. The output voltage for a given ampere turn signal input is proportional to N . However, since the effective output impedance is approximately proportional to N^2 , the power output into a matched load is substantially independent of the number of turns.

Multiple Configurations

As a logical consequence of the above relationships magnetors have been constructed with multiple windings, giving the designer a wider choice of N for various functions. When separate excitation windings are employed a further advantage may be gained by pairing the magnetor with a second two-winding core structure. The excitation windings may then be connected in opposing fashion while the signal input and output windings are connected in aiding fashion. This arrangement is shown schematically

Table I—Typical Characteristics of Tubular Cores

Core Length (in.) (cm)		Outer Diameter (cm)	Core Material Area (sq cm)	μ'	Figure of Merit ($\mu' \times \text{Area}$)
.75	1.9	0.27	0.006	200	1.2
1.0	2.5	0.27	0.003	600	1.8
1.0	2.5	0.27	0.006	300	1.8
1.0	2.5	0.27	0.023	75	1.7
1.5	3.8	0.24	0.003	1,000	3.0
2	5.1	0.16	0.003	1,400	4.2
2	5.1	0.16	0.013	300	3.9
2	5.1	0.24	0.003	2,000	6.0
2	5.1	0.24	0.013	400	5.2
4	10.2	0.27	0.005	2,200	11
4	10.2	0.27	0.013	1,100	17
4	10.2	0.32	0.003	4,000	12
48	122	0.32	0.010	15,000	150

jection filter is necessary between the output of the excitation source and the magnetor to reduce the spurious second harmonic reaching the useful output circuit.

Good regulation or level stability of the excitation source is essential in order to realize the minimum noise from magnetors.

A single-tube oscillator combining the attributes of low output impedance (less than 10 ohms) and excellent level stability is shown in Fig. 5. The power output is around 10 milliwatts.

Output Filters

Two factors determine to a large extent the requirements for the output filter used with a magnetor. First, the bandwidth must be adequate to handle the sidebands corresponding to the highest signal input frequency. Second, the discrimination against the excitation frequency and odd harmonics thereof must be sufficient to reduce their contributions to zero offset and noise to acceptable values. The filter may also be designed to fulfill two additional functions—impedance matching to the grid of an electron tube, and providing a series or parallel feed path for the signal input current.

The simplest form of filter capable of meeting these requirements consists of a tuned circuit. For ratios of excitation frequencies of the order of 50 or greater, such simple filters or impedance-transforming pi circuits are quite adequate. For bandwidths in the order of 10 percent of the excitation frequency, band-pass structures are necessary. Care must be exercised to insure that the inductors employed in the filters do not themselves act as magnetors and impair the overall linearity. This can be avoided by using inductors having air cores or suitable magnetic cores exhibiting low modulation.

A phase modulator, as noted previously, is useful for conversion to d-c of the filtered and amplified magnetor output with output polarity corresponding to that of the input. Such a phase modulator is capable of discriminating against unwanted second harmonic voltages in quadrature with the voltages of

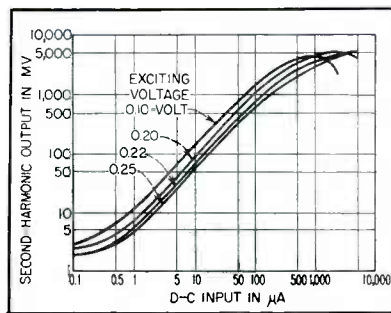

FIG. 6—Curves show linearity between d-c input and a-c output

the same frequency produced by signal inputs.

A magnetor designed for use in an automatic telephone line insulation resistance test set furnishes a practical example of the usefulness of such devices.

Insulation Tester

The requirements for this application called for the linear conversion of signal currents of 1 to 100 microamperes in the frequency range of d-c to 100 cycles. Particularly troublesome to the tube approach were the stipulations that the measuring circuit could introduce no more than 50 ohms resistance in the circuit, and that the entire signal circuit must operate off ground.

The magnetor circuit arrangement of Fig. 4 successfully meets these requirements. A twin-toroidal-core magnetor with single-turn cores, as shown in Fig. 3, is employed. Exciting windings are 200 turns each and the signal windings are 1,000 turns each. The exciting frequency of 1,000 cycles is derived from the single-tube oscillator shown in Fig. 5. The second harmonic output is selected with a filter having a pass band 200 cycles in width.

The d-c input—a-c output characteristics are shown in Fig. 6 for four values of exciting voltage. The slope is about 10 millivolts per microampere corresponding to a transimpedance including filter step-up of 10^4 ohms. The power gain in the magnetor itself is about 6 db. The zero-signal output is equivalent to an input of less than one-half microampere or about 10^{-12} watts. The linearity is excellent from 1 to 100 microamperes

and the overload point is greater than 1,000 microamperes. Since the signal input impedance is 30 ohms, the zero-signal residual or offset corresponds to less than 20 microvolts. The signal-frequency response is flat within 3 db from direct current to 100 cycles.

A magnetor of the twin-core type having 70 convolutions in each core and windings similar to that mentioned above was tested with its output connected to a wave analyzer. Excitation was provided by a well-filtered 1,000-cycle oscillator. The second harmonic output into one megohm for a one-microampere signal was 70 millivolts. This corresponds to a transimpedance of 70,000 ohms. The power gain in the magnetor alone was more than 1,000, or 30 db. The zero-signal residual or offset and noise was less than one-tenth microampere or less than 10^{-12} watts. The output was linear from 0.1 up to 100 microamperes. The equivalent output impedance of the magnetor was in the order of 200,000 ohms.

Magnetors offer advantages over other techniques for signal conversion in many applications.

A great deal of exploratory work still needs to be done to realize their full potentialities. However, as a note of caution, prediction of their performance is difficult, and measurements are not easy because of the unusual and changing waveforms encountered and the number of parameters involved. It is hoped that this paper will stimulate activity in this somewhat neglected field.

BIBLIOGRAPHY

- E. Peterson, U. S. Patent 1,678,163.
- E. F. W. Alexanderson, U. S. Patents 1,206,643 and 1,328,473.
- G. W. Elmen, U. S. Patent 1,586,885.
- E. T. Burton, U. S. Patent 2,147,688 and 2,164,333.
- J. M. Manley, Some General Properties of Magnetic Amplifiers, *Proc. IRE*, 39, p 242, March 1951.
- P. H. Dowling, U. S. Patent 1,739,579.
- C. W. La Pierre, U. S. Patent 2,053,154.
- O. W. Livingston, U. S. Patent 2,450,286.
- F. C. Williams and S. W. Noble, The Fundamental Limitations of the Second Harmonic Type of Magnetic Modulator as Applied to the Amplification of Small D-C Signals, *Proc. IRE, Part II*, 97, p 445, Aug. 1950.
- W. A. Geyger, *Archiv f. Technisches Messen*, 634-4, p T22, Feb. 1949.
- Gunnar Wennerberg, A Simple Magnetic Modulator for Conversion of Millivolt D-C Signals, *Electrical Engineering*, 70, p 144, Feb. 1951.
- E. P. Feich, W. J. Means, T. Slonezewski, L. G. Parratt, L. H. Rumbaugh and A. J. Tickner, Airborne Magnetometers for Search and Survey, *Trans. AIEE*, 66, p 641, 1947. Abridged, *Electrical Engineering*, 66, p 680, 1947.
- E. P. Feich et al U. S. Patent 2,488,389.

Broad-Banding

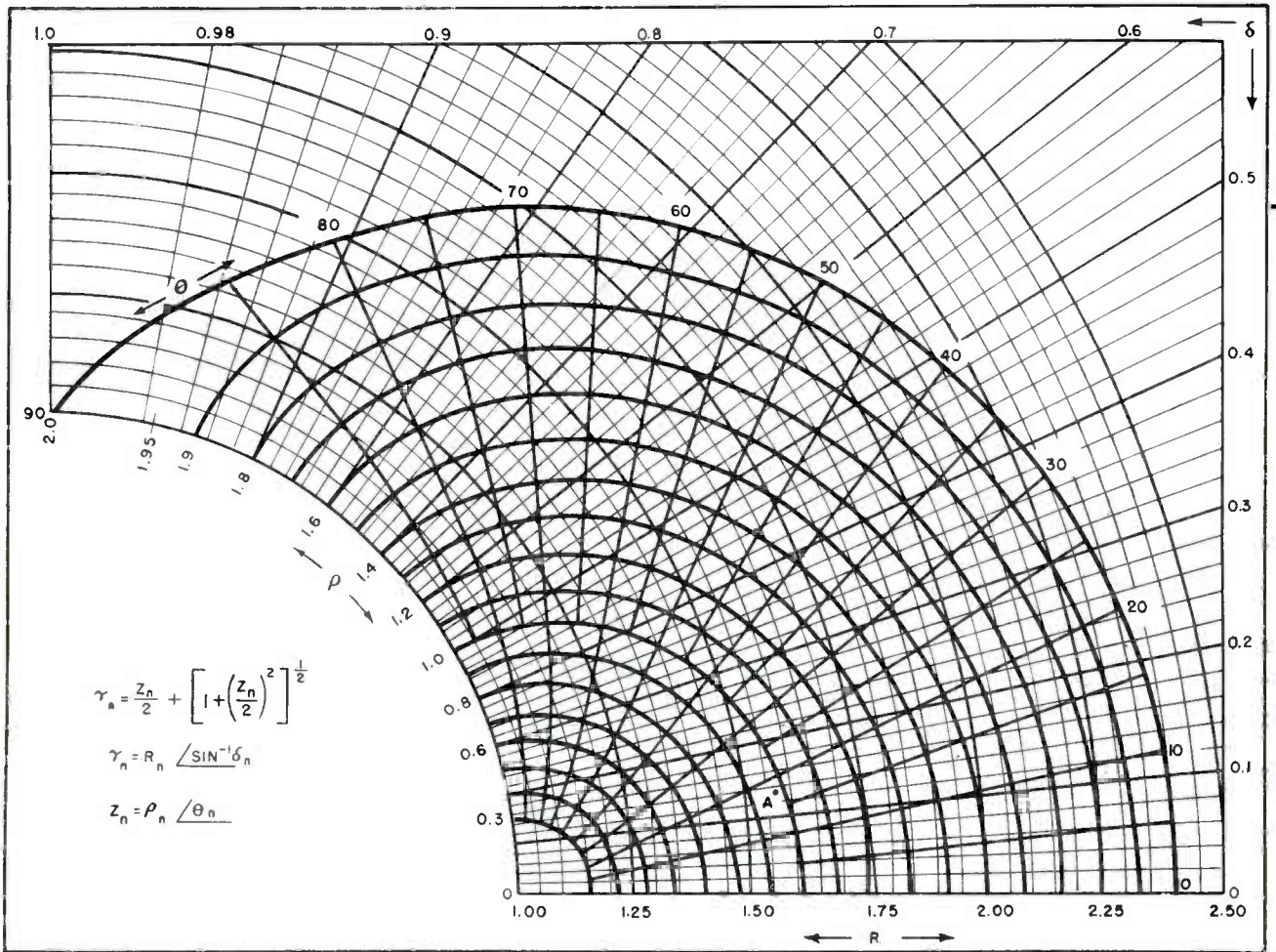

FIG. 1—Plot of Eq. 1 covering the range of ρ_n from 0.3 to 2.0 and θ_n from 0 to 90 degrees. Values of θ_n from 90 to 180 degrees are geometrically symmetrical

INCREASING developments in electronics, such as radar and television, require numerous applications of wide-band i-f amplifiers.

This article with the aid of nomographs and charts, simplifies the design calculations of two types of stagger-tuned i-f amplifiers, that is, the Butterworth (or maximally flat) response and the Tschebycheff (or equal-ripple) response. Provisions are made for bandwidths up to twice the center frequency and for two-pole to six-pole staggers.

The usual method of design is to calculate the equivalent low-pass poles (or resonant frequencies and their damping factors) and then transform these poles to their desired band-pass values by

By ROLAND C. WITTENBERG

*Airborne Instruments Laboratory, Inc.
Mineola, N. Y.*

$$\gamma_n = Z_n/2 + [1 + (Z_n/2)^2]^{1/2} \quad (1)$$

where

$$Z_n = \rho_n \angle \theta_n \quad (2)$$

$$\gamma_n = R_n \angle \sin^{-1} \delta_n \quad (3)$$

$$R_n = f_n/f_o \quad (4)$$

$$2\delta_n = B_n/f_n = \text{damping factor of band-pass pole} \quad (5)$$

ρ_n = magnitude of low-pass pole

θ_n = phase angle of low-pass pole

f_n = frequency of n th pole (or stage)

B_n = bandwidth of n th pole

Equation 1 is plotted in Figure 1. This chart covers a range of ρ_n from 0.3 to 2.0 and θ_n from 0 to 90 degrees. For values of ρ_n less than 0.3, the approximations (Eq. 20 and 21) for Equation 1 result in more

accurate values. The values of θ_n from 90 to 180 degrees are not necessary because of the geometric symmetry exhibited by the band-pass poles for both the Butterworth and Tschebycheff type of stagger. This fact is used to reduce the number of calculations. For N poles:

$$R_{N+1-n} = 1/R_n \quad (6)$$

$$\delta_{N+1-n} = \delta_n \quad (7)$$

where n is a particular stage of an N -uple stagger, $n = 1$ is the highest frequency of the N -uple, and $n = N$ is the lowest frequency of the N -uple. Another saving is for the case where N is odd. The center pole (ρ_c, θ_c) is always at 90 degrees ($R_c = 1.00$) and δ_c is equal to $\rho_c/2$.

To use the chart in Figure 1, the

by Stagger Tuning

Simplified design calculations use nomographs and tables to compute either Butterworth or Tschebycheff-response stagger-tuned i-f amplifiers. Resultant wide-band circuits for radar and television have practicable conformations, and employ noncritical components

low-pass equivalent pole is calculated in a vector form ($\rho_n \angle \theta_n$). Then simply go into the chart to the point representing this vector and read off the corresponding values of R_n and δ_n . The actual frequencies and bandwidths can then be found from Eq. 4 and 5.

The following definitions are for both the Butterworth and the Tschebycheff type of stagger.

$$\begin{aligned} f_u &= \text{upper frequency of pass band} \\ f_L &= \text{lower frequency of pass band} \\ f_o &= (f_u f_L)^{\frac{1}{2}} = \text{center frequency} \\ &\quad \text{(geometric)} \\ \alpha &= (f_u - f_L)/f_o \end{aligned} \quad \begin{matrix} (8) \\ (9) \end{matrix}$$

The first type of design is the Butterworth or maximally flat stagger. It has the response shown in Fig. 2. The normalized gain (G_o), as a function of frequency, is of the form

$$G_o = 1/(1 + x^{2n})^{\frac{1}{2}} \quad (10)$$

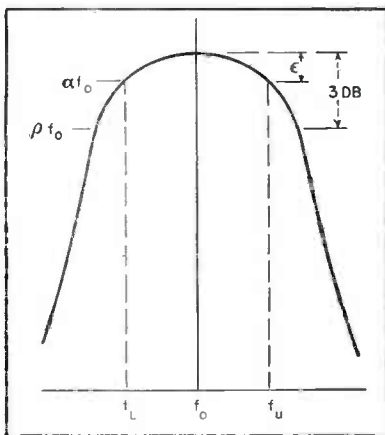

FIG. 2—Response of a circuit with Butterworth or maximally flat stagger

where

$$x = \frac{1}{\alpha} \left[\frac{f}{f_o} - \frac{f_o}{f} \right] \quad (11)$$

Equation 11 is for the usual case where the amplitude response is down 3 db at $f = f_u$ and $f = f_L$. However, if it is desired to have

the response down only ϵ db at f_u and f_L , then α must be increased by a factor $1/y$. Symbol y represents the bandwidth reduction factor and depends only upon N and ϵ . It may be found from the nomograph in Fig. 3. Eq. 11 then becomes

$$x = \frac{y}{\alpha} \left[\frac{f}{f_o} - \frac{f_o}{f} \right] \quad (12)$$

The mean stage gain of a Butterworth staggered amplifier is

$$G = 20 \log \left[\frac{g_m}{2 \pi f_o C} \frac{y}{\alpha} \right] \quad (13)$$

where g_m = the tube transconductance

C = the total shunt capacitance
For the Butterworth case

$$\rho_1 = \frac{\alpha}{y} = \rho_2 = \rho_n \quad (14)$$

$$\theta_n = \frac{2n - 1}{N} (90) \text{ degrees} \quad (15)$$

The required values of θ_n are listed in Table I for values of N from 2 to 6.

Butterworth Method

An example of a Butterworth design will be given to clarify the design procedure.

A quintuple stagger-tuned amplifier is required to have a pass band flat within 0.2 db from 20 to 40 megacycles.

$$\begin{aligned} N &= 5 \\ \epsilon &= 0.2 \text{ db} \\ f_u &= 40 \text{ megacycles} \\ f_L &= 20 \text{ megacycles} \\ f_o &= (f_u f_L)^{\frac{1}{2}} = (20 \times 40)^{\frac{1}{2}} = 28.3 \text{ mc} \\ \alpha &= (f_u - f_L)/f_o \\ &= (40 - 20)/28.3 = 0.707 \\ y &= 0.73 \text{ (from Fig. 3)} \end{aligned}$$

Therefore $\rho_1 = \alpha/y = 0.707/0.73 = 0.969$

$\rho_1 = \rho_2 = \rho_3 = \rho_4 = \rho_5 = 0.969$
From Table I, $\theta_1 = 18^\circ$, $\theta_2 = 54^\circ$, $\theta_3 = 90^\circ$

R_1 and δ_1 can be found from Fig. 1 at point (A) where $\rho_1 = 0.969$ and $\theta_1 = 18$ degrees.

$$R_1 = 1.56 \quad \delta_1 = 0.135$$

Similarly $R_2 = 1.35$ $\delta_2 = 0.370$
 ρ_3 is the center pole of an odd N -uple, therefore

$$R_3 = 1.00, \text{ and}$$

$$\delta_3 = \frac{\rho_3}{2} = \frac{0.969}{2} = 0.485$$

By symmetry (Eq. 6 and 7)

$$R_4 = 1/R_2 = 1/1.35 = 0.742$$

$$\delta_4 = \delta_2 = 0.370$$

$$R_5 = 1/R_1 = 1/1.56 = 0.641$$

$$\delta_5 = \delta_1 = 0.135$$

The actual frequencies and bandwidths are found from Eq. 4 and 5

$$f_1 = R_1 \times f_o = (1.56)(28.3)$$

$$= 44.2 \text{ megacycles}$$

$$B_1 = 2 \delta_1 f_1 = 2(0.135)(44.2)$$

$$= 11.9 \text{ megacycles}$$

Similarly

$$f_2 = 38.2 \text{ mc}, B_2 = 14.1 \text{ mc}$$

$$f_3 = 28.3 \text{ mc}, B_3 = 27.4 \text{ mc}$$

$$f_4 = 21.0 \text{ mc}, B_4 = 7.8 \text{ mc}$$

$$f_5 = 18.1 \text{ mc}, B_5 = 4.9 \text{ mc}$$

POLES

The frequency response of an electrical network can be expressed as the ratio of two polynomials. The roots of the numerator polynomials are called zeros and those in the denominator are called poles. These roots are useful tools in that they completely describe the response of the network. Therefore, knowing these roots, the response of the network can be readily determined. Or, if a given type of response is desired, the response may be broken down into its individual roots (or poles). For a stagger-tuned amplifier each pole can be represented by a single tuned circuit. If the pole is written as a vector quantity, its magnitude represents the resonant frequency and its phase angle is a measure of the damping in the tuned circuit

Assuming 6AK5's are used

$$g_m = 5,000 \mu\text{mhos}$$

$$C = 11.0 \mu\mu\text{i}$$

The mean stage gain may be calculated from Eq. 13

$$G = 20 \log \left[\frac{(5,000 \times 10^{-6}) (0.73)}{(2\pi) (28.3 \times 10^6) (11 \times 10^{-12}) (0.707)} \right]$$

$$G = 8.4 \text{ db}$$

Since all the tubes are the same, the total gain is five times the mean stage gain or 42 db.

Equal Ripple Method

The Tschebycheff or equal ripple response is calculated by a method similar to that used for the Butterworth response. The gain versus frequency response for this type of design is shown in Fig. 4. The gain variation over the pass band is $\pm \epsilon/2$ or a total of ϵ db. The number of bumps in the response corresponds to the degree of the stagger.

Since the degree of staggering

and the desired gain tolerance are known, the value of $\sinh \beta$ and $\tanh \beta$ can be found from Fig. 5. Now ρ_n can be calculated from the following equation

$$\rho_n = \alpha [(\cos \varphi_n)^2 + (\sinh \beta)^2]^{\frac{1}{2}} \quad (16)$$

$\cos \varphi_n$ is listed in Table II. (φ_n is the equivalent of θ_n in Table I). The value of θ_n can be found from Fig. 6 using $\tan \theta_n$ from Table II and $\tanh \beta$.

The center pole of an odd N -uple is simply

$$\rho_c = \alpha \sinh \beta$$

$$\theta_c = 90 \text{ degrees} \quad (17)$$

With these values of φ_n and θ_n , the actual frequencies and bandwidths can be calculated in the same manner as for the Butterworth stagger.

The mean stage gain for the Tschebycheff stagger is

$$G_n = 20 \log \left[\frac{g_m}{2\pi f_o C \rho_n} \right] + \frac{1}{2N} (-1)^N \epsilon \quad (18)$$

The total gain is simply the sum of the mean stage gains and for a design using the same tubes throughout (g_m and C are the same for all stages) the total gain becomes

$$G = 20 N \log \left[\frac{g_m}{2\pi f_o C} \right] + 20 \log \left[\frac{1}{(\rho_1)(\rho_2) \dots (\rho_N)^{\frac{1}{2}}} \right] + (-1)^N \frac{\epsilon}{2} \quad (19)$$

Where $\varphi_{N+1-n} = \varphi_n$

As an example of a Tschebycheff design the bandwidth, gain tolerance, and degree of staggering will be chosen the same as for the Butterworth example.

$$N = 5$$

$$\epsilon = 0.2 \text{ db}$$

$$f_u = 40 \text{ mc}$$

$$f_L = 20 \text{ mc}$$

$$f_o = 28.3 \text{ mc}$$

$$\alpha = 0.707$$

From Fig. 5 for $N = 5$ and $\epsilon = 0.2 \text{ db}$

$$\sinh \beta = 0.46 \quad \tanh \beta = 0.42$$

From Table II for $N = 5$ and $n = 1$

$$\cos \varphi_1 = 0.951, \quad \tan \varphi_1 = 0.325$$

ρ_1 can be found by Eq. 16

$$\rho_1 = \alpha [(\cos \varphi_1)^2 + (\sinh \beta)^2]^{\frac{1}{2}}$$

$$= 0.707 [(0.951)^2 + (0.46)^2]^{\frac{1}{2}}$$

$$\rho_1 = 0.747$$

θ_1 can be found from Fig. 6 using $\tan \theta_1$ and $\tanh \beta$

$$\theta_1 = 7.7 \text{ degrees}$$

Similarly $\rho_2 = 0.528$ and $\theta_2 = 30 \text{ degrees}$

ρ_3 is the center pole of an odd N -uple, therefore

$$\rho_3 = \alpha \sinh \beta = (0.707) (0.46) = 0.325$$

$$\theta_3 = 90 \text{ degrees}$$

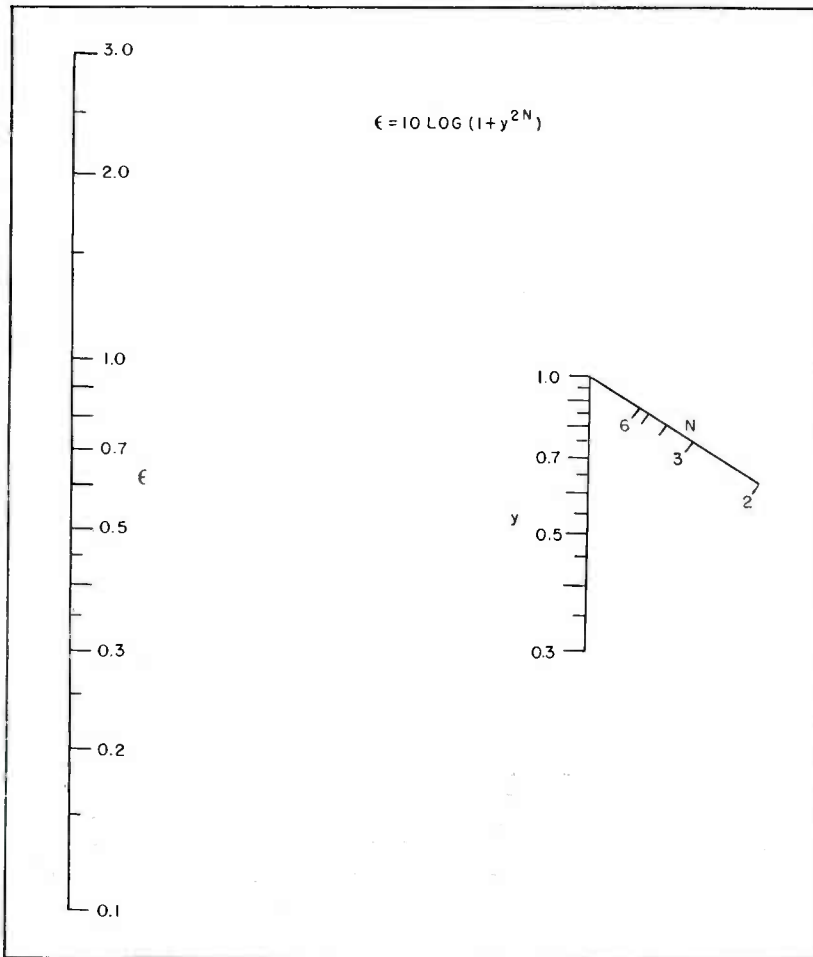

FIG. 3—Nomograph for finding bandwidth-reduction factor y that depends upon the number of poles N and attenuation ϵ for the upper and lower pass-band frequencies

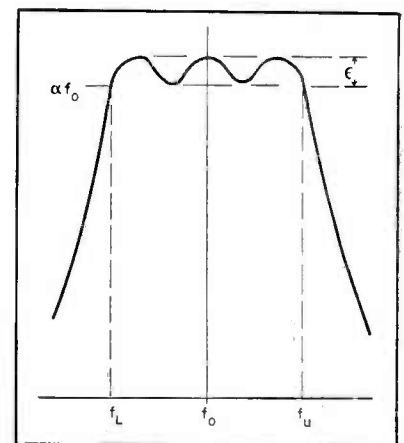

FIG. 4—Gain-frequency response for a Tschebycheff or equal-ripple stagger

Table I—Phase Angle of Low-Pass Pole

N	θ_n Degrees		
	n = 1	n = 2	n = 3
2	45.0	—	—
3	30.0	90.0	—
4	22.5	67.5	—
5	18.0	54.0	90.0
6	15.0	45.0	75.0

Table II—Tan ϕ_n Used to Find ϕ_n from Fig. 6

N	n = 1		n = 2		n = 3	
	Cos ϕ_1	Tan ϕ_1	Cos ϕ_2	Tan ϕ_2	Cos ϕ_3	Tan ϕ_3
2	0.707	1.00	—	—	—	—
3	0.866	0.577	0	—	—	—
4	0.924	0.414	0.383	2.41	—	—
5	0.951	0.325	0.588	1.38	0	—
6	0.966	0.268	0.707	1.00	0.259	3.73

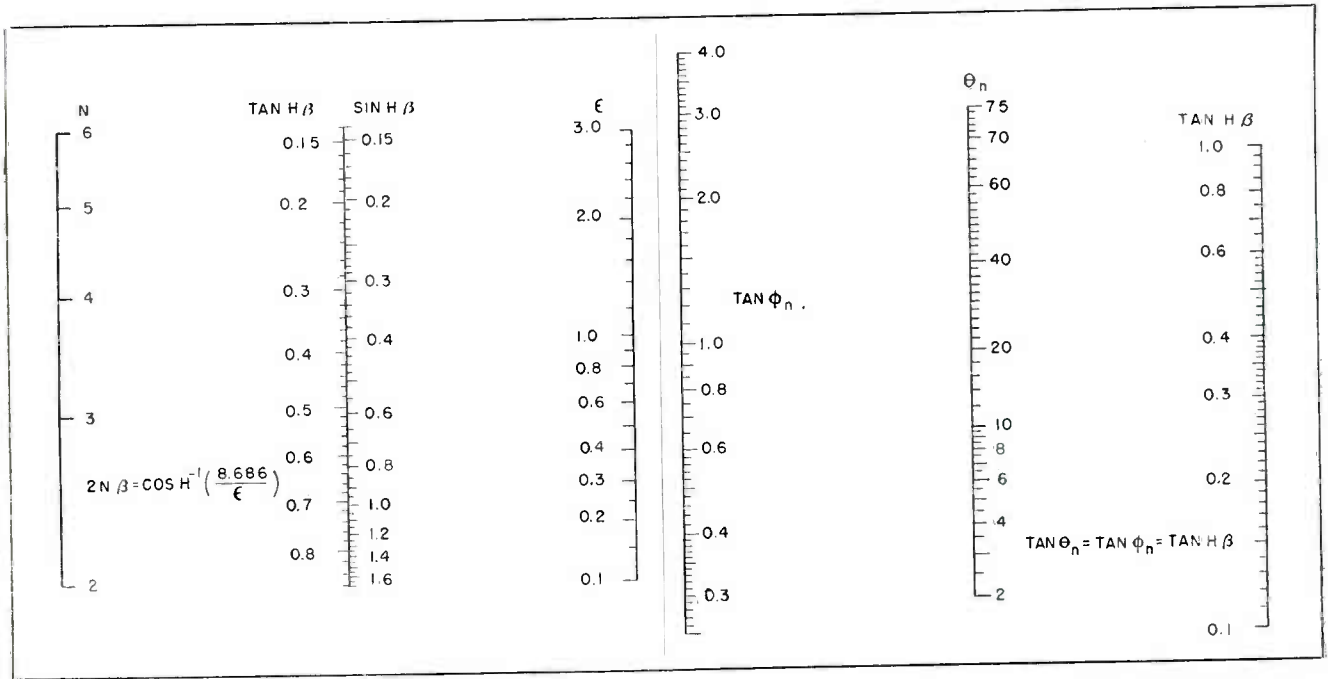

FIG. 5—Intermediate-computation nomograph used to find sinh β and tanh β by the Tschebycheff-stagger technique

FIG. 6—Determine ϕ_n from values in Table II and Fig. 5. The value for ρ_n using the equal-ripple stagger, is found by Eq. 16

Now R_n and δ_n can be found from Fig. 1

$$R_1 = 1.43, \delta_1 = 0.050$$

$$R_2 = 1.26, \delta_2 = 0.125$$

$$R_3 = 1.00, \delta_3 = \rho_3/2 = 0.163$$

By symmetry (Eq. 6 and 7)

$$R_4 = 1/R_2 = 1/1.26 = 0.79,$$

$$\delta_4 = \delta_2 = 0.125$$

$$R_5 = 1/R_1 = 1/1.43 = 0.70,$$

$$\delta_5 = \delta_1 = 0.050$$

The actual frequencies are found the same way as for the Butterworth response.

$$f_1 = R_1 f_o = (1.43)(28.3) = 40.4 \text{ mc}$$

$$B_1 = 2\delta_1 f_1 = (2)(0.050)(40.4) = 4.04 \text{ mc}$$

Similarly $f_2 = 35.6 \text{ mc}, B_2 = 8.9 \text{ mc}$
 $f_3 = 28.3 \text{ mc}, B_3 = 9.2 \text{ mc}$
 $f_4 = 22.4 \text{ mc}, B_4 = 5.6 \text{ mc}$
 $f_5 = 19.8 \text{ mc}, B_5 = 1.98 \text{ mc}$

Using 6AK5's, as in the Butterworth example, the total gain by Eq. 19 is

$$G = (20)(5) \log$$

$$\left[\frac{5,000 \times 10^{-6}}{(2\pi)(28.3 \times 10^6)(11 \times 10^{-12})} \right] + 20 \log$$

$$\left[\frac{1}{(0.747)(0.528)(0.325)(0.528)(0.747)} \right]$$

$$+ (-1)^5 \frac{0.2}{2}$$

$$G = 40.7 + 25.9 - 0.1 = 66.5 \text{ db}$$

Cascading Butterworth or Tschebycheff N-uples

If a given stagger (Butterworth or Tschebycheff) is cascaded m times, the gain tolerance is increased m times. Therefore, with the overall gain tolerance given, the gain of the individual stagger is equal to the overall gain tolerance divided by the degree of cascading (m).

When ϕ_n is less than 0.3, R_n and δ_n cannot be found by using Fig. 1 because the lines are squeezed.

However, they can be found by the approximations of Eq. 1 given below.

$$R_n = 1 + \frac{\rho_n}{2} \cos \theta_n \quad (20)$$

$$\delta_n = \frac{\rho_n}{2} \sin \theta_n \quad (21)$$

After R_n and δ_n are found as shown above, the design is continued in the same manner as if the values of R_n and δ_n were found from Fig. 1.

BIBLIOGRAPHY

- S. Butterworth, On the Theory of Filter Amplifiers, *Wireless Engineer*, p 536, 1930.
- Courant-Hilbert, "Methoden der Mathematischen Physik", p 75, Springer, Berlin, 1934.
- W. H. Huggins, The Natural Behavior of Broadband Circuits, Air Force Cambridge Research Laboratories Report E5013, May 1948.
- G. E. Valley, Jr. and H. Wallman, "Vacuum Tube Amplifiers", p 166, McGraw-Hill Book Co., New York, 1948.
- H. Wallman, Stagger Tuned I-F Amplifiers Radiation Laboratory, MIT, Report 524, Cambridge, Mass.

Filament Supply

Moderate degree of regulation required for heating 6-volt filaments of some 4,000 tubes in a computer is provided. Error signal acts through chopper, amplifier and grid limiters to control firing time of thyratrons in primary legs of three-phase transformers

voltage on tube V_{AC} be negative until V_{AC} is to be triggered, at which time it should rise rapidly. Since the square-wave voltage present at the secondaries of transformer T_1 will be in phase with e_{ON} , one of these secondaries is chosen and so polarized that its voltage e_{QN} will go positive at 30 degrees. This will allow conduction of V_{AC} even earlier in the e_{AC} cycle if the output voltage is low, as will be seen.

Now, suppose a positive difference or error voltage exists. Then the polarity is chosen so that an a-c voltage e_{AN} in phase with phase A will be applied in the grid circuit of V_3 - V_4 . The grid-to-cathode voltage on tube pair V_3 - V_4 will now be the algebraic sum of the voltages e_{ON} and e_{AN} , giving voltage e_p . The square-wave voltage e_p' will now be obtained instead of e_{ON}' , so that thyatron V_{AC} will be fired 10.9 degrees later.

Actually, a sinusoidal voltage of approximately 110 volts peak to peak is maintained between the plate of V_3 or V_4 and ground. Exaggerated magnitudes of error are chosen for clarity of illustration in Fig. 2 since the principle is the same. Normal regulation occurs at much smaller error amplitude. For example, an error of 0.01 volt introduced across the converter input gives a peak-to-peak sinusoidal voltage of approximately 120 volts between the plate of V_3 or V_4 and ground with no a-c introduced into the cathodes of V_3 - V_4 .

Thus, if e_{AN} has a maximum amplitude A which is $+0.2 C$ where C is the maximum amplitude of e_{ON} , the delay angle will be 10.9 degrees. Also, the resulting maximum amplitude of the resultant voltage e_p will be $0.918 C$. The square-wave voltage e_p' is then produced by e_p .

Similarly, if the amplitude A is $-0.2 C$, giving the voltage shown as $-e_{AN}$ corresponding to an error voltage representing too low an output voltage, the resultant sinusoidal voltage shown as e_Q will be obtained which will lead e_{AN} by 9 degrees as will the square-wave voltage e_Q' produced by e_Q . Voltage e_Q will then trigger thyatron V_{AC} earlier and therefore increase the output voltage.

While a definite value of line voltage E_{AC} is shown, this voltage is the principal source of variation which requires adjustment of the time of firing to obtain output voltage control. At starting, the line voltages as well as the output voltage are both low, particularly since the coarse autotransformer is used then, hence the phase shift is considerably leading so that the thyratrons are fully conducting throughout the starting period.

An a-c voltmeter is switched across the thyatron pairs to measure and allow adjustment of the regulating voltage E_r appearing across them. For the 30-degree angle shown as the mean position of

operation in Fig. 2 and the rms value for E_{AC} of $700/\sqrt{2}$ volts, E_r has the value of 84 volts. Actually, for a 1,000-ampere load the measured value of E_{AC} was 495 rms volts and E_r was 70 rms volts. The triggering angle for this condition was therefore slightly less than 30 degrees. The above formula does not take into account tube drop, which is approximately 15 volts during conduction, and waveform distortion which may be appreciable.

To filter the output of the supply, a 0.25-mh reactor having a resistance of 0.1 milliohm and a nominal capacitance of one farad was used. The reactor is of the internal-gap type to minimize external field. The capacitance is considered interesting, not only because of its large value, but also because of the method of mounting the 166 individual capacitors of 6,000 microfarads each on their connecting terminals to minimize lead length. The effective capacitance was greater than one farad in the frequency range where it was desired that it be most effective, due to the inductance of the leads. Measurements at 420 cycles gave an effective capacitance of approximately 1.8 farad and a series resistance of 6.8×10^{-4} ohms.

To test the supply, long strips of Nichrome V four inches wide and 0.03 inch thick were connected in parallel as desired and cooled by fan. After some adjustment of the stabilizing network to the values of 30 ohms and 300 μ f shown in series across the error voltage input circuit in Fig. 1, stable regulation was obtained for load values from 25 to 1,680 amperes. The hum level dropped slightly from 4.5 mv for the 25-ampere load to 2.5 mv at full load.

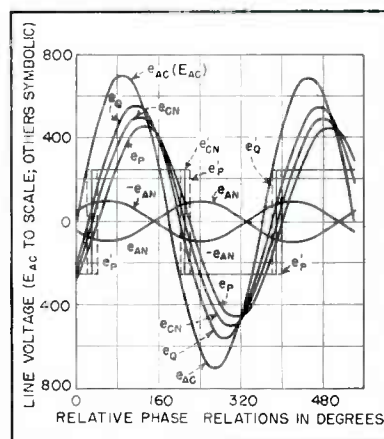

FIG. 2—Firing control curves for one of thyratrons in the circuit

Evaluating Performance

By **JULIUS GREEN**

Research Division
Philco Corporation
Philadelphia, Pennsylvania

TELEVISION receiver performance is and should be evaluated on the basis of the qualitative, subjective judgment of the viewers. However, the engineer attempting to design a component part of the receiver should be provided with a quantitative method for evaluating the performance of each component to avoid the time-consuming, subjective method of evaluating the final picture by viewing.

The performance of the r-f, i-f, video and deflection circuits can be quantitatively evaluated by well-known and convenient methods. Unfortunately, the designer of the display tube and its associated components does not have such convenient methods. The picture brightness and the range contrast can be measured photometrically, but the detail contrast, which largely determines the picture quality, lacks a convenient quantitative method of measurement. The detail contrast is primarily determined by the cross-section of the electron beam striking the phosphor, but it is also affected by halation and diffusion of light in the phosphor. The designers of the electron gun,

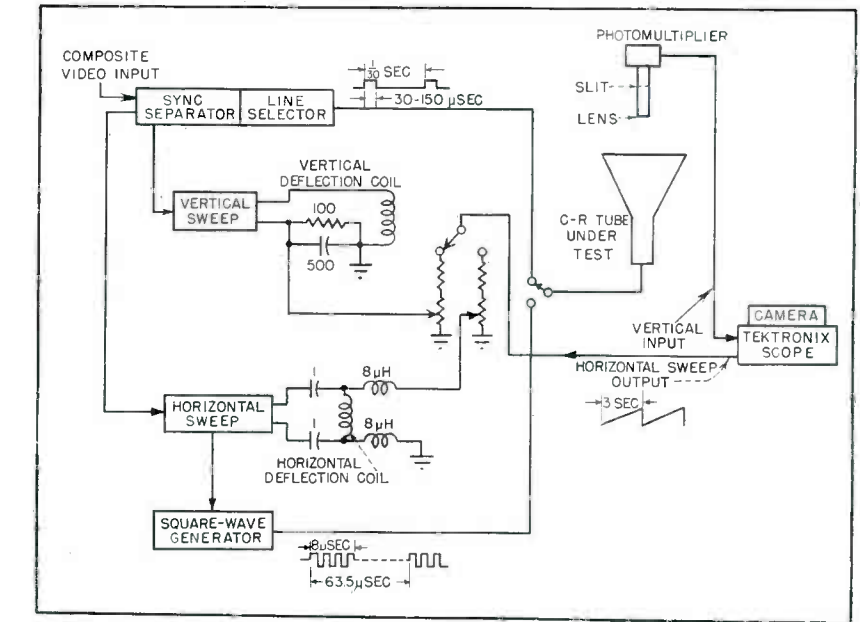

FIG. 1—Block diagram of system for measuring c-r tube spot dimensions under actual operating conditions

the focusing device and deflection yoke, and the phosphor would be helped considerably by accurate measurement of the detail contrast at various points of the tube face.

Many present methods of measurement of spot size are based on compression of raster size until the line or dot structure of the raster disappears¹, or on visual inspection using a microscope. These methods suffer from inaccuracy because a certain amount of judgment is required, and they do not take into account the effects of the diffusion disk of the spot and halation on the picture quality.

This paper will describe a method of measurement and an experimental equipment which has been built and used by the Philco Research Division to measure spot size and detail contrast.

Object of Measurements

Since the spot size is of premier importance in determining picture quality, measurement of its dimensions, or its effect, is of primary importance. By spot is meant the spot of light as viewed from the front of the picture tube face. Since the spot may be round only at the center of the tube face, becoming el-

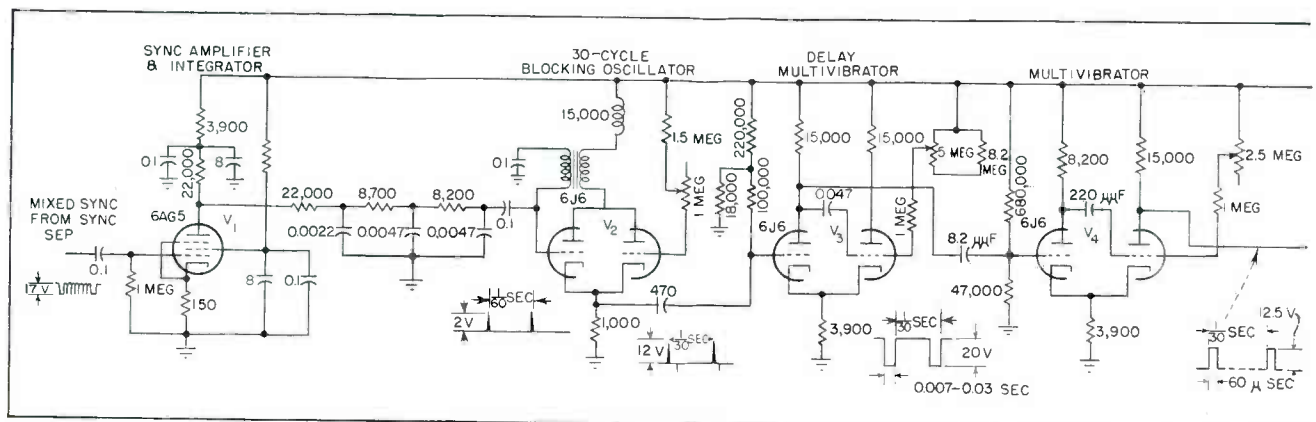
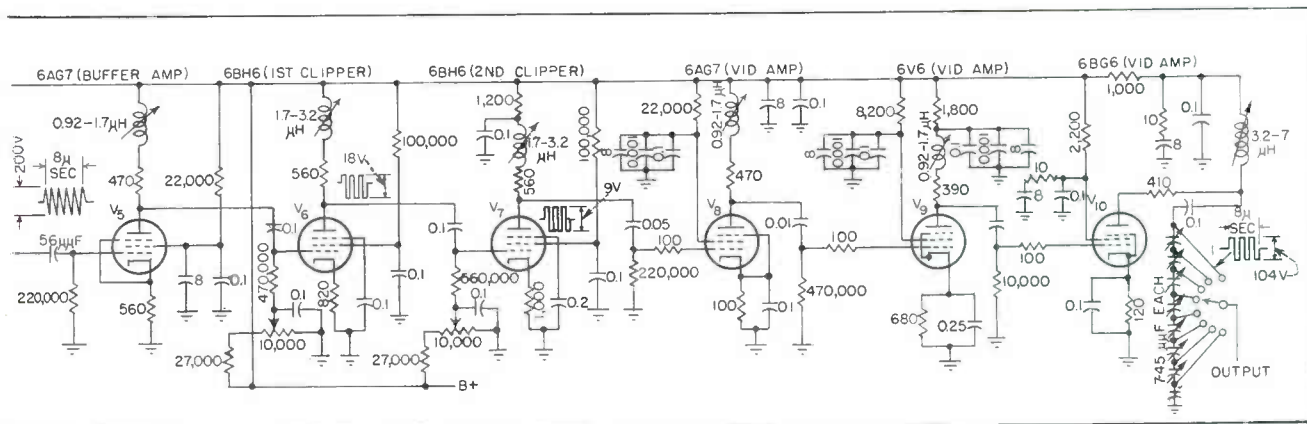

FIG. 2—Line selector unblanks c-r tube to show one line or two adjacent lines for measuring



vertical bars of adjustable fineness for determining horizontal dimension of spot

rectangles indicate the successive relative positions of the inspection aperture and the raster line at the times when the deflected spot is writing the raster line. The number of looks per 3-second scan of the line is usually much greater than shown. It can be seen that the line is effectively scanned by the slit aperture and the envelope of the pattern on the oscilloscope is a plot of light intensity vertically across the line, with light intensity as ordinate and distance as abscissa. The pattern may then be photographed using a 3-sec time exposure. To improve the presentation, the base line of the oscilloscope, which would otherwise be very bright, is erased by applying the amplified photomultiplier signal to the cathode of the oscilloscope crt.

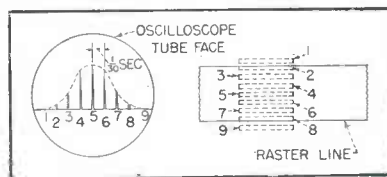

FIG. 5—Simplified representation of line-width measuring technique

The base line is restored to the photograph by another exposure with no photomultiplier output.

Calibration

To calibrate the photograph with respect to distance, a companion photograph of two lines is taken under identical conditions. The distance between the peaks is then 1/245 of the raster height, for a

standard television raster.

Figure 6 shows the results obtained with a four-inch tube usually used in flying-spot scanners and projection television. From these photographs, the line width, or vertical spot dimension is easily obtained.

The critical nature of the focus adjustment is well illustrated by Fig. 6. It was found in the course of the work that it was necessary to adjust the focus current using the pattern on the oscilloscope as the criterion. The long persistence of the scope P-7 phosphor helps this adjustment.

Measurements have shown that the spot does not have the usually assumed e^{-x^2} distribution of intensity. The distribution usually is more nearly the form

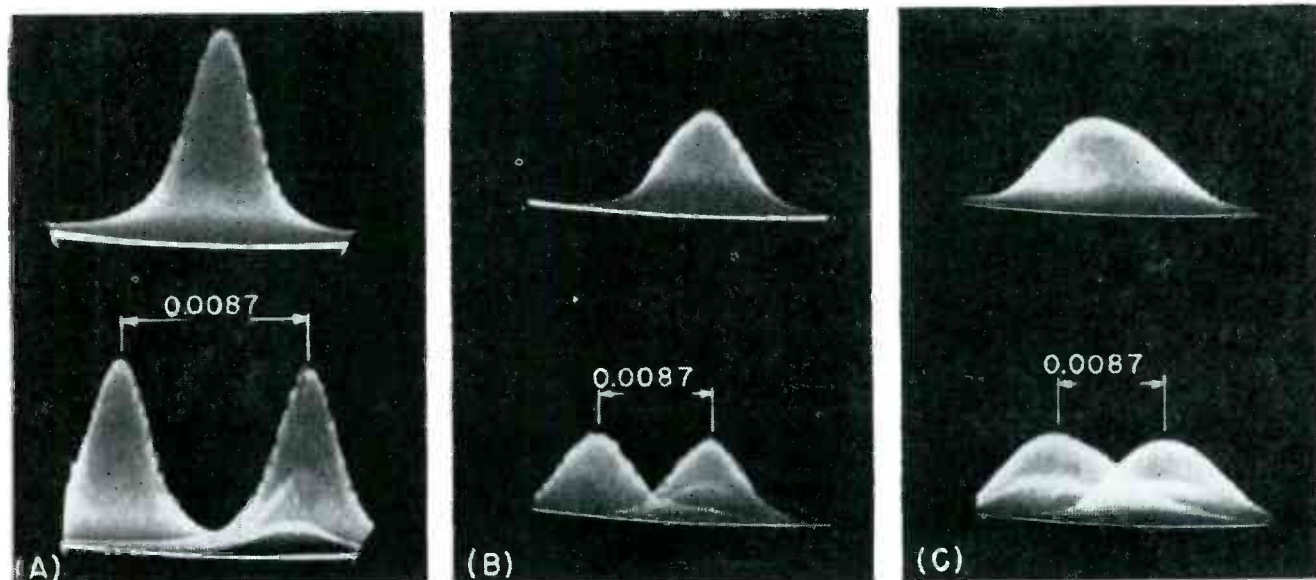

FIG. 6—Oscillograms showing vertical distribution of light intensity for a single line and for two adjacent lines on a TP-400A projection tube. Focus currents are A, 39 ma; B, 38 ma, and C, 40 ma. Comparison shows importance of correct focus current

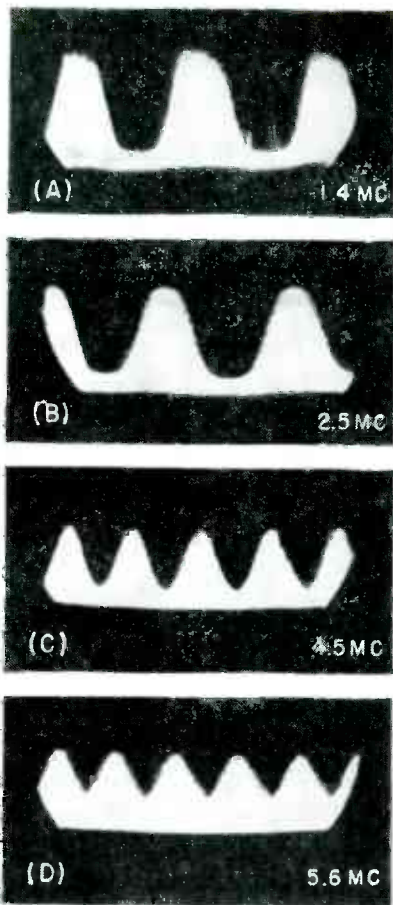

FIG. 7—Oscillograms show horizontal resolution resulting from square wave of four frequencies being applied to grid of a 16WP4 picture tube. At low frequencies, output is approximately square, but at 5.6 mc, considerable rounding off has occurred

$$A e^{-(K_1 x)^2} + B e^{-(K_2 x)^2}$$

where A and K_1 are respectively several times larger than B and K_2 . It is not clear whether the tails indicated are due to the electron beam distribution or to light diffusion in the phosphor.

Contrast Measurements

In measuring contrast versus line number, the square-wave generator output is applied to the grid of the c-r tube under test. The optical system is focused on the phosphor as before with the slit now parallel to the vertical bars. The oscilloscope sweep output terminal is connected to the horizontal deflection coil of the tube under test causing the raster to move horizontally in a sawtooth fashion past the optical system. The result is a plot of light intensity versus horizontal

distance. A typical result is shown in Fig. 7.

Aperture Theory

In understanding the origin and significance of these measurements, a brief simplified summary of aperture theory is helpful. Consider an illuminated pattern of black and white bars viewed by reflected light. Let us move a small square inspection aperture over and at right angles to these bars, and plot the total light flux from the pattern passing through the aperture versus time (Fig. 8). If the aperture is infinitesimally small compared to the bars, the resultant plot is almost exactly the brightness of the bars versus distance. As the bars become finer and comparable to aperture width, the plot becomes a poorer reproduction of the pattern. It can readily be seen that the effect of any aperture on the reproduction of the pattern can be summarized by a curve of $\psi_{\max} - \psi_{\min}$ versus δ/A or, normalizing, a curve of $\frac{\psi_{\max} - \psi_{\min}}{(\psi_{\max} - \psi_{\min})_0}$ versus δ/A where $(\psi_{\max} - \psi_{\min})_0$ is the difference in peak flux obtained for bars very large compared to the aperture. Furthermore, these curves can be calculated for various shaped apertures with nonuniform transmission².

Bar Patterns

The same concepts can be applied to a bar pattern painted on a surface by an aperture turned on and off in square-wave fashion and moved across the surface, provided that conditions are such that the surface integrates: that is, the brightness of a point on the surface is proportional to the time integral of the painting flux which has hit it. Since it is a fair assumption that a commercial television c-r tube satisfies this condition, it should then be possible to specify the size and shape of the painting aperture, the light spot, by obtaining the

$$\frac{B_{\max} - B_{\min}}{(B_{\max} - B_{\min})_0}$$

curve where B is the brightness of the phosphor and the subscript 0 refers to the condition where the bars are much larger than the light spot. It should be noted, however, that this curve describes completely

the effect of the light spot on the square-wave information to be painted on the face of the tube.

Furthermore, this curve, which, after Schade, we call the amplitude response curve, is comparable to a frequency response curve which would be obtained by inserting at the input of a video amplifier a square wave of fundamental frequency f and measuring the peak-to-peak voltage output as f is increased: that is, the square-wave frequency response of the amplifier. In this way, physical apertures and amplifiers have similar effects on signal information passed through them.

Typical Case

To illustrate, consider the subject system. For simplicity, we shall employ square apertures of uniform transmission. The square wave emerges from the square-wave generator with a rise time of approximately 0.03 μ sec. The spot on a 16-inch standard television tube with a 13.7-inch wide raster, moves horizontally at a rate of 0.24-inch per μ sec or 0.0072-inch in 0.03 μ sec. We can, therefore, consider the square-wave generator as a square aperture of 0.0072-inch width through which we have passed the ideal square wave before applying it to the c-r tube.

Since the aperture or light spot of the usual 16-inch tube is several times larger than 0.0072 inch, the effect of the square-wave generator aperture is negligible by comparison.

Similarly, the effect of the optical system aperture, approximately 0.0008-inch wide, is negligible, and the predominant deterioration of the pattern obtained and photographed on the face of the oscilloscope is due to the light spot of the c-r tube under test. The situation is exactly analogous to taking the frequency response of several cascaded low-band-pass amplifiers where the frequency response obtained is that of the amplifier with the band pass much narrower than the others.

The data of Fig. 7 were taken with the square-wave generator output adjusted so that the cathode current of the c-r tube under test was driven from the indicated peak

value to zero. Since the bars of Fig. 7A are much wider than any reasonable value for the spot size, one would expect B_{min} to be zero. This is obviously not the case. Halation maintains the minimum brightness value and thus lowers the detail contrast regardless of the spot size.

As illustrated in Fig. 7B, C and D, however, the square wave begins to lose its shape due to the spot size and the contrast also decreases due to spot size. The likeness of the tube to a low-band-pass filter is indicated by the fact that only the fundamental component of the higher frequency square waves is reproduced.

The amplitude response curves from the data of Fig. 7 are shown in Fig. 9. The abscissa here is the number of vertical black or white bars which could be placed on the full raster of the tube; that is, the line number equals the horizontal sweep time, 53.5 μ sec,

multiplied by twice the square-wave fundamental frequency. Because of the halation and the nonlinear input grid characteristics, the horizontal spot size and shape cannot be inferred from these curves. However, they are in themselves of value in that they completely describe the effect of the tube under test on square-wave patterns of various fineness.

The gated square-wave signal, suitably attenuated, can be inserted at the video amplifier input of a television receiver, thus ascertaining the effect of the video amplifier on the final pattern reproduction, or it can be used to modulate signal generators for insertion in the receiver r-f or i-f sections. By comparing the various results obtained, one could evaluate the effect of the various sections on the definition of the final picture.

It should also be noted that a gated sine wave signal could be used instead of the square wave signal

for all these tests.

The effects of astigmatism or edge defocusing on the picture can be evaluated by measuring the line width and the amplitude response curve at various points on the c-r tube and comparing to the results obtained at the center.

Conclusions

This method provides a permanent quantitative record of the filter characteristics of a c-r tube assembly. It can be used to determine the effect of changes in the design of the electron gun, focus device, deflection yoke or phosphor on some of

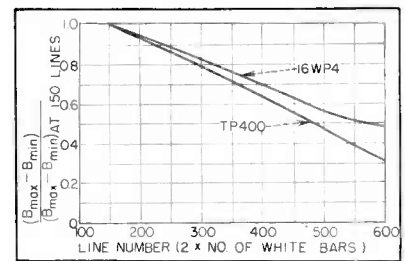

FIG. 9—Measured amplitude response curves obtained with equipment described

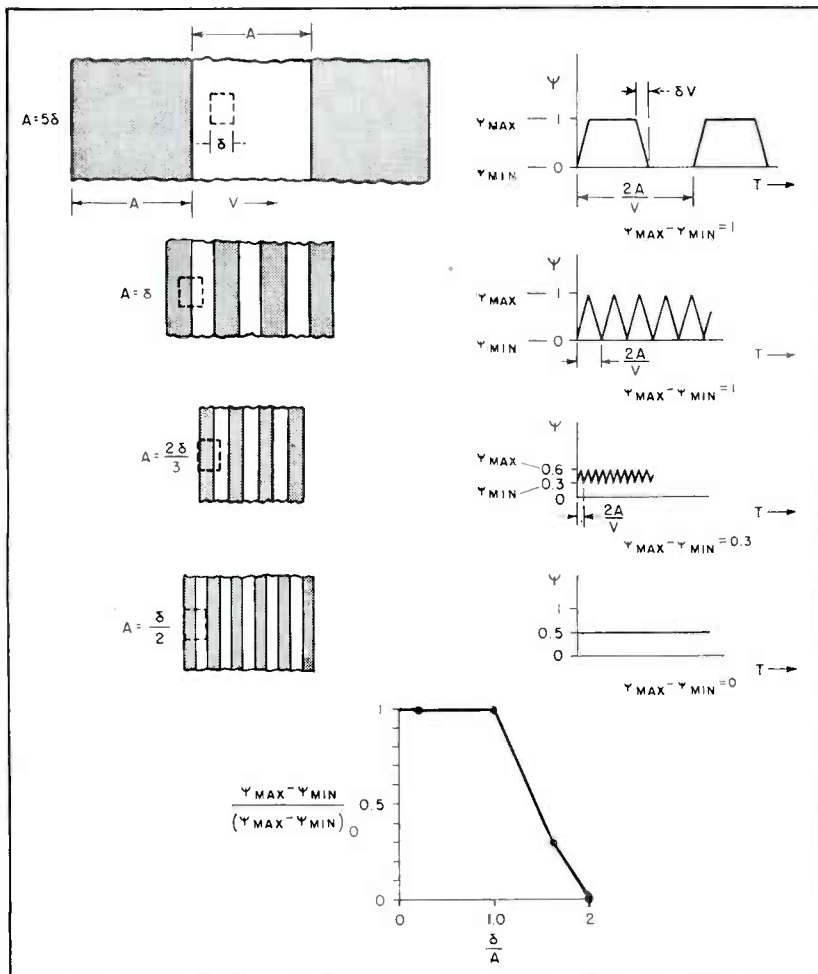

FIG. 8—Aperture method of studying picture quality

the dominant factors which influence television picture quality.

It should be noted that any c-r tube testing setup can be adapted to take these measurements. A line selector, a gated square or sine-wave generator, a modified microscope and a Tektronix Model 512 oscilloscope with a suitable camera are the only additional equipment needed. The stability of the deflection circuits must be very good to prevent considerable error in the measurements.

Acknowledgements

The construction of the apparatus was originally suggested by H. A. Affel, Jr. Among those who contributed to the design and construction are A. Cavaliere, H. B. Collins, Jr. and G. Turin.

REFERENCES

- (1) Soller, Starr, Valley. "Cathode Ray Tube Displays," Vol. 22, Radiation Laboratory Series, McGraw-Hill Book Co., Inc., N. Y.
- (2) O. H. Shade. Electro-Optical Specifications for Television Systems, *ECA Review*, p 245, June 1948.
- (3) R. R. Law. Contrast in Kinescopes, *Proc. IRE*, p 511, Aug. 1939.

Microwave Antenna

By JOHN W. TILEY

Research Division
Philco Corporation
Philadelphia, Pennsylvania

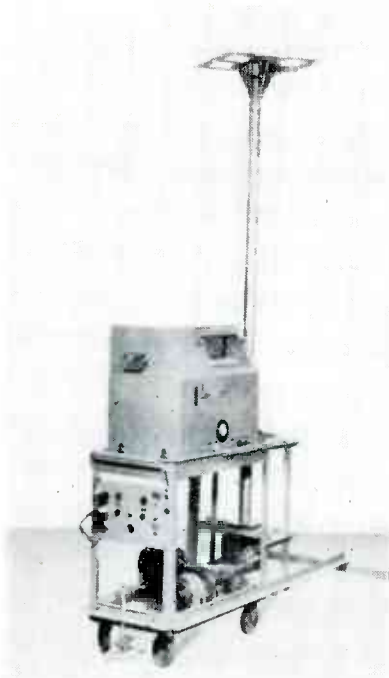

FIG. 1—Antenna sits on rotating platform which turns with recording drum



FIG. 2—Special absorbing screen eliminates reflections

TO OVERCOME the inherent time-consuming process of recording antenna patterns manually, without requiring unnecessarily expensive equipment, a compact, automatic antenna pattern recorder has been developed. The instrument is shown in Fig. 1.

Careful mechanical and electrical design has made it possible to record satisfactorily a complete 180-degree curve in two minutes, a speed which is adequate for present applications. Transmitter power level changes or frequency drifts are not likely to be appreciable in a two-minute period. Provisions are also made for minimizing energy radiated from surrounding objects.

Location of Equipment

In determining a suitable location for the transmitting antenna, reflecting surfaces must be avoided. Since the receiving antenna is to be tested, the transmitter is fixed, but the location is usually such that a portion of its energy is reflected and thus arrives at the receiving antenna at a small angle. In this

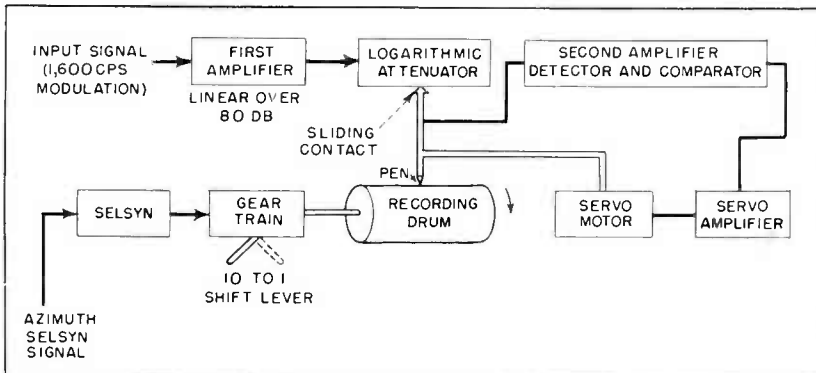

FIG. 3—Block diagram shows pen-drive servo system

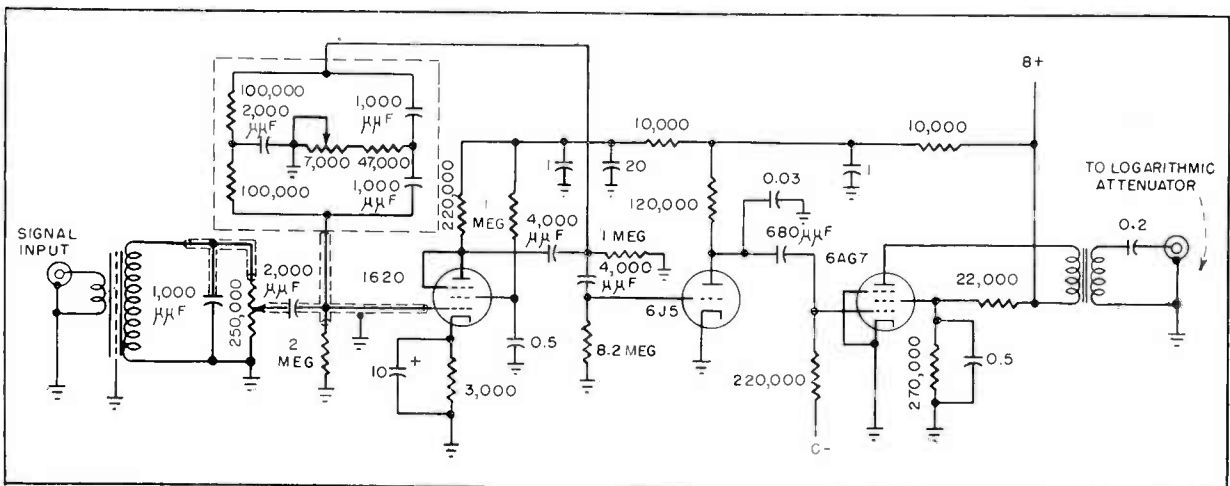

FIG. 4—First amplifier receives signal from bolometer detector and passes it to logarithmic attenuator

Pattern Plotter

Furnishing a complete pattern in two minutes, this automatic instrument turns antenna platform and recording drum in synchronism, while detector-amplifier-servo system drives recording pen in accordance with variations in received energy. Special absorbing surface eliminates interfering reflections

case it would be impossible to achieve accurate antenna gain measurements since the standing waves due to the sum of the two different beams add up to different energy levels in the receiving area as the plane of the antenna is changed. The actual effect on the antenna pattern would be to render the results below the major lobe inaccurate, the degree of inaccuracy being dependent on the power level and direction of such extraneous radiation.

To increase the accuracy of the results, an r-f probe is used to determine the energy levels over the receiving area. Where standing waves of any appreciable magnitude exist, the transmitting antenna must be changed. Probing is done in the absence of the receiving antenna to eliminate this cause of field distortion.¹

When approximate tests of antenna patterns are made in the laboratory, greater freedom from reflection has been made possible by the development of a black absorbing surface.² This unit is able to absorb energies from 3,000 mc

to at least 30,000 mc. The vswr of an antenna looking into this surface is approximately 1.05 to 1 over the above frequency range with the protective plastic screen in place.

A portion of the absorbing screen is shown in Fig. 2. The screen consists of 1½-inch square pyramids 6 inches high which are cast from a mixture of lamp black and plaster of paris in sections 18 by 3 inches and assembled in a wood frame six feet square. During measurements the screen is placed behind the receiving antenna being tested so that energy passing the test antenna will not be reflected back and cause erroneous results.

Servo System

Recording of the antenna pattern is accomplished by means of the electromechanical system shown in Fig. 3. It consists essentially of a first (bolometer) amplifier which receives a signal from the bolometer detector and passes it through the logarithmic attenuator into the second (potentiometer) amplifier where the signal level is increased so that it may be detected.

After detection the signal is applied through a bridge to the servo amplifier, amplified and applied to the servo motor which is connected through a string drive to the recording pen and logarithmic attenuator, thus completing the circuit. All time constants throughout the system must be fast with respect to the mechanical time constant of the servo motor since it is the motor which determines the speed of recording.

The first amplifier, shown schematically in Fig. 4, must have an output range of greater than 80 db. This is necessary as the square-law detector output voltage is proportional to the r-f input power, thus requiring the amplifier to have twice the range that is recorded. To achieve this range, power supply ripple or line noise feed-through must be minimized. The input transformer must be located in an area free from a-c magnetic fields; grid bias voltages must be kept free from a-c from the power supply or from other amplifiers; and suitable shields must be inserted where necessary.

The first amplifier uses a twin-T feedback network, but differs from the ordinary bolometer amplifier in that moderate output power is required to drive the 600-ohm logarithmic attenuator. The pass band of the twin-T must be wide enough to allow transmission of the sharp peaks or valleys in the pattern.

Attenuator

The logarithmic attenuator, shown in Fig. 5, has a low impedance so that stray pickup and drift may be minimized. It consists of a resistance card with a bar attached along one side and a pickup probe that slides along the other side parallel to the bar. The input terminal is attached to a point in line with the

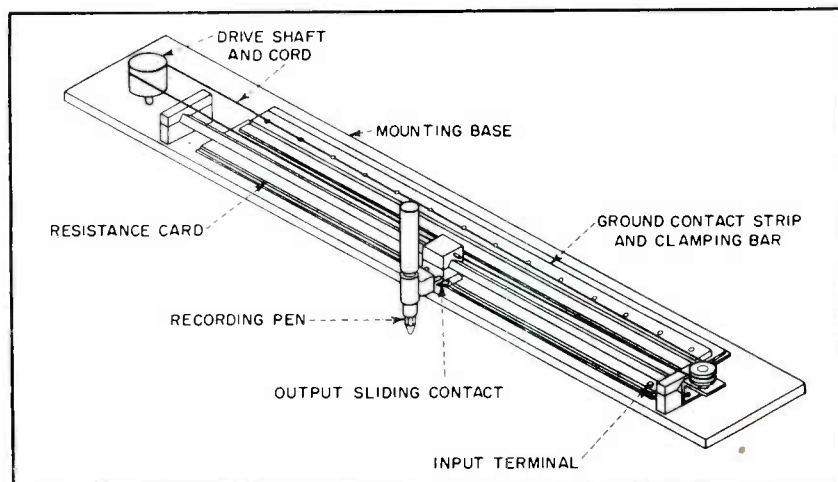

FIG. 5—Attenuator is calibrated within 0.1 db over the top 30 db of the full 40-db range

pickup probe path. Adjusting fingers are provided at points along the bar so errors due to slight non-linearity of the first amplifier, variations of resistance in the card and other minor sources may be reduced.

When a signal generator and an accurate attenuator are used as a calibrating means, it is possible to adjust the accuracy of the attenuator over the top 30 db of the complete 40-db range within 0.1 db; the accuracy of the lower ten db is usually limited by local noise. When the maximum signal is applied the actual attenuation will be 80 db.

Second Amplifier

The main function of the second amplifier (Fig. 6) is to increase the signal to a reasonable level for detection. The 1-millivolt input signal is thus amplified to a level of one or two volts before it is detected. To reduce contact noise, this is a twin-T type of feedback amplifier.

The 1N34 germanium detector is followed by half a 6SN7 used as a cathode follower as shown in Fig. 6. The d-c output level is adjusted to the input requirements of the servo amplifier by means of the network in the cathode circuit of the 6SN7. A constant d-c voltage of suitable level is provided by a voltage-dropping network.

The d-c signal is chopped in the servo amplifier at a 60-cycle rate, amplified and fed to the servo motor. Since the drive motor determines the recording speed, its speed may be reduced to record ex-

tremely sharp peaks or valleys. All time constants in the amplifier in the servo loop are small with respect to the time constant of the servo motor for this reason. The transient response of the servo system is indicated in Fig. 7, which was obtained by switching a 10-db pad in and out of the input circuit.

The power supply is regulated and filtered. A pair of 5W4's feed a pair of 6L6's controlled by a 6SL7 to provide adequate protection from a-c line voltage changes. Twenty volts a-c line change produces little change in d-c output level. Bias voltages are supplied by a separate transformer, 6 X 4 rectifier tube, and an 0A3 voltage regulator tube.

A special mechanical system for driving the turntable and drum had to be devised so that repeat errors in azimuth of not greater than 0.1 degree could be obtained. Referring to Fig. 8A, the drive energy branches at the motor in two directions, one to the turntable and the other through a pair of selsyns to the recording drum. The drive is

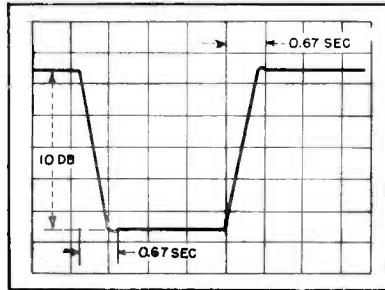

FIG. 7—Transient response curve for servo system obtained by switching 10-db pad in and out of input circuit

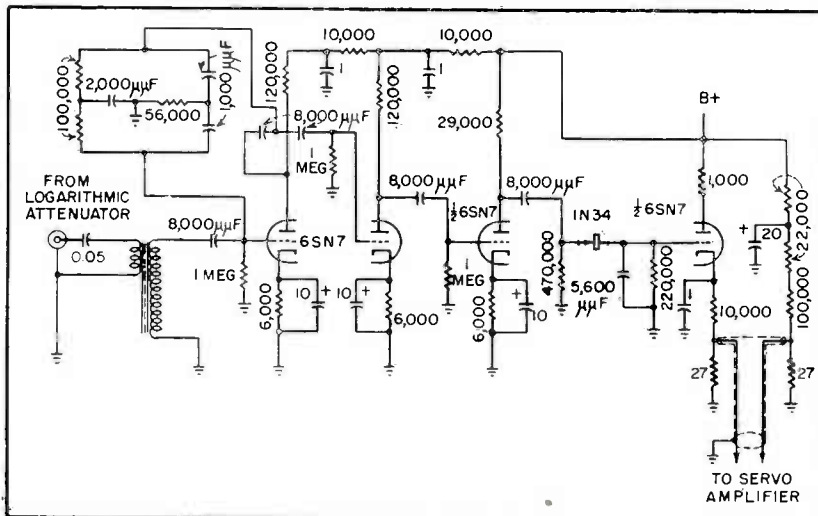

FIG. 6—Second amplifier takes signal from logarithmic attenuator and applies it to conventional servo amplifier

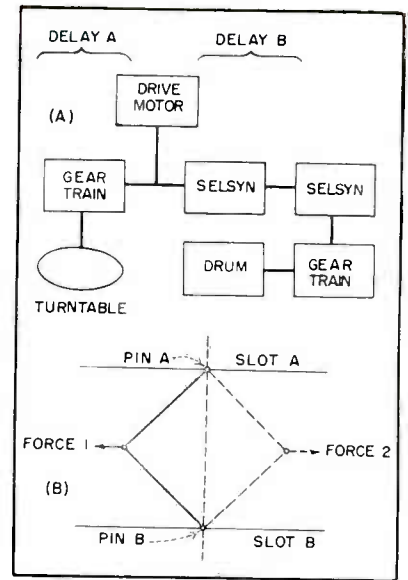

FIG. 8—Mechanical system drives turntable and drum in synchronism with azimuth error of not greater than 0.1 degree

shown in Fig. 8B. Two pins (connected by string) move respectively in two straight parallel slots.

For purposes of illustration, the string is loose with its ends anchored in the two pins. The drive force is applied at the center of the string in a direction parallel to the slots. When the drive direction is reversed, the two pins will start in the reverse direction at a later time, but moving simultaneously. Thus in the recorder, regardless of selsyn or gear backlash, the turntable and drum always move simultaneously. The two requirements of this mechanical system are the use of good quality gears and good mechanical design. A backlash adjustment is provided on one set of gears for fine adjustment of tracking.

Conclusions

Many plots have been made with the automatic antenna recorder, and the results have been very satisfactory. Thus, by a thorough consideration of extraneous radiation and a well-designed recorder, it is now possible to make accurate antenna plots in both the field and laboratory without the laborious and time consuming process of manual recording.

REFERENCES

- (1) Samuel Silver, "Microwave Antenna Theory and Design", Vol. 12, Rad. Lab. Series, McGraw-Hill Book Co., Inc., New York.
- (2) U. S. Patent No. 2,464,006.



STANDARD ELECTRONIC COMPONENTS

For the past quarter of a century CINCH Components have filled the requirements developed by the rapid changes in the Electronics industry. Today, judged by demand and performance, CINCH is producing the STANDARD metal plastic assembly.

Consult Cinch

Cinch components are available at leading Electronic jobbers—everywhere



Cinch
ELECTRONIC
COMPONENTS

CINCH MANUFACTURING CORPORATION

1026 South Homan Ave., Chicago 24, Illinois

Subsidiary of United-Carr Fastener Corporation, Cambridge, Mass.

Atmospheric Absorption Chart

Varying absorption of microwaves, millimeter waves and infrared rays by the atmosphere is analyzed and charted for region from 0.001 mm to 10 cm. Absorption peaks should be avoided when designing radar and communication equipment

By **ARNOLD SHOSTAK**

*Electronics Branch, Office of Naval Research
Washington, D. C.*

FACTORS affecting the amount of absorption experienced by a propagated electromagnetic wave include: path length, water vapor content and oxygen content of the air. The combined effects of these factors are shown in the accompanying chart.

The drop in 4-cm waves is about 0.01 db per kilometer, whereas in the oxygen absorption band around 5 mm the drop may be as high as 10 db per km. The infrared waves from 1 to 500 microns (0.001 to 0.5 mm) usually sustain complete absorption in the first 15 meters, with ensuing attenuation due to scattering.

Water exists in the atmos-

phere both in the form of rain drops and in the form of vapor. The amount of water per unit volume is dependent on temperature. Rain drops, as a function of their diameter and the wavelength of the propagated wave, mostly result in scattering of the wave energy. Water vapor, on the other hand, is made up of H_2O molecules which have a permanent electric dipole moment. This moment interacts with the electric vector of the impinging electromagnetic field, with resultant energy absorption. The water vapor absorption band in the region of 1.33 cm is due to this type of interaction. Carbon dioxide also has

a permanent electric dipole moment that causes absorption.

Oxygen does not have a permanent electric dipole moment; it does, however, possess a permanent magnetic moment. This moment interacts with the magnetic vector of the electromagnetic wave to cause absorption, principally around 5 mm.

Most of the factors governing absorption of electromagnetic waves are thus manifested in the very short wavelength regions, from 0.001 mm to about 20 mm. Waves above 3 cm are attenuated by scattering, especially in rainstorms, but the relative effect is usually small compared to absorption in the smaller wavelength regions. In the infrared, violent oscillations in the plot of wavelength versus absorption are noted, principally due to the closely-spaced energy levels of the various molecules of the gases making up the atmosphere. Infrared transmission at sea-level is limited to very short ranges and must exploit the wavelengths of low absorption indicated in the chart. As may be noted, these bands of low absorption, called windows, are of very narrow width, compelling the use of very selective generators and receivers for successful transmission of electromagnetic energy over significant distances at these wavelengths.

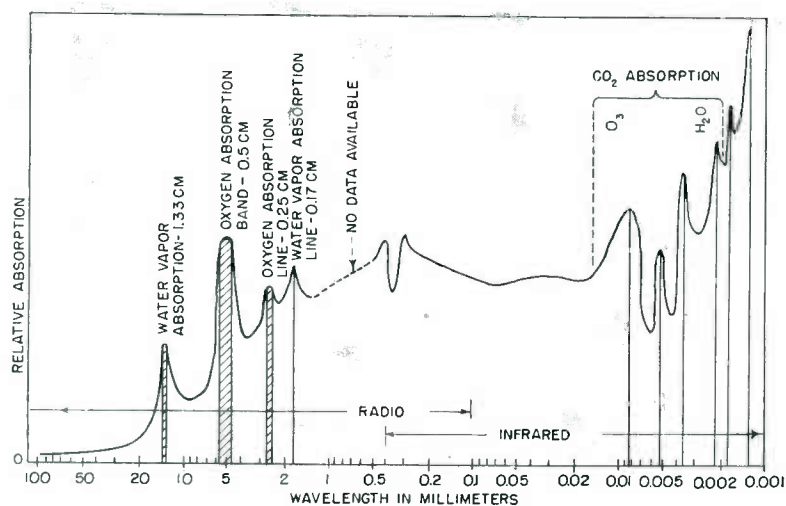

Relative atmospheric absorption at sea level and temperature of 20 deg C



IN GYRO RINGS . . . WHERE SPACE IS SHORT



High Density Mallory 1000 Metal Does the Job . . . Economically!

Expect More . . . Get More From Mallory

When you turn to Mallory for help with a metallurgical problem, you take advantage of the services of a versatile engineering organization backed by years of research and production experience.

This engineering knowledge, when teamed with Mallory products, has meant product improvement and extra savings for many Mallory customers—improvements, savings and service beyond expectation.

Perhaps Mallory can do for you what it has done so successfully for others.

Wherever extreme density and great strength are required—as in rotors, flywheels, balance weights or a shield for radium or x-rays—you can depend on Mallory 1000 Metal to do the job. Count on this sintered Tungsten-base alloy for . . .

- HIGH DENSITY . . .** Mallory 1000 Metal has a density of 16.8 to 17.0 grams per cubic inch.
- HIGH STRENGTH . . .** Mallory 1000 Metal has a tensile strength of over 80,000 lbs. per square inch.
- EASY MACHINABILITY . . .** Mallory 1000 Metal machining is like that of grey iron in operation and chip.
- DRIFT RESISTANCE . . .** Mallory 1000 Metal shows no objectionable drift at rotational speeds as high as 35,000 RPM.

In many cases, Mallory 1000 Metal and Mallory engineers have teamed to give users better performance at real savings. Why not write for details today?

*In Canada, made and sold by Johnson Matthey and Mallory, Ltd.,
110 Industry St., Toronto 15, Ontario*

Metallurgical Products and Alloys

P. R. MALLORY & CO. Inc.
MALLORY

SERVING INDUSTRY WITH

Electromechanical Products—Resistors • Switches • TV Tuners • Vibrators
Electrochemical Products—Capacitors • Rectifiers • Mercury Dry Batteries
Metallurgical Products—Contacts • Special Metals • Welding Materials

P. R. MALLORY & CO., INC., INDIANAPOLIS 6, INDIANA

ELECTRONS AT WORK

Including INDUSTRIAL CONTROL

Edited by RONALD K. JURGEN

Automatic Currency-Selector Unit.....	136	Noise Test for Solderless Connectors.....	175
F-M Detector Tuning-Indicator Circuit.....	138	Fast Setting Up of Temporary Circuits.....	178
Model Antenna Range.....	138	Line-Terminated Pulse Stretcher.....	186
Low-Frequency Oscillator Adapter.....	140	Control System for Induction Heaters.....	194
Tachometer Pickup Device.....	146	Multichannel Remote-Control System.....	202
Photographing R-F Modulation Patterns.....	154	E-F Rewarming.....	210
Gain-Stabilized Mixer.....	170	Ultrasonic Tire Testing.....	214

Automatic Currency-Selector Unit

By PAUL J. SELGIN

Chief, Engineering Electronics Section
National Bureau of Standards
Washington, D. C.

AUTOMATIC VENDING and change-making devices perform a necessary function and an increasingly important one in view of personnel shortages. Usefulness of such equipment has been limited by the inability to handle paper currency. The device to be described is capable of accepting paper currency with a relatively good margin of safety.

Requirements

The requirements of a suitable paper selector are as follows: Operation must not depend on exact placement of the bill. By having a receptacle or slot exactly fitted to the dimensions of the bill, approximate positioning without effort or attention on the part of the opera-

tor may be obtained. The operating cycle must be short, preferably less than five seconds. The machine must be simple, dependable and require a minimum of service. Last, the machine must be relatively inexpensive.

The unit finally evolved, called the Nomoscope, is essentially a camera. It is used as a camera initially, before it is put into normal operation, to produce a partial negative. This negative is reduced in size and is an authentic copy of the document placed in the slot *S* of Fig. 1. After developing, the negative is put back into its holder *H*. In operation, another copy is placed in *S*. A lid (not shown) presses it down against the transparent floor of the slot, initiating the operating cycle by the clos-

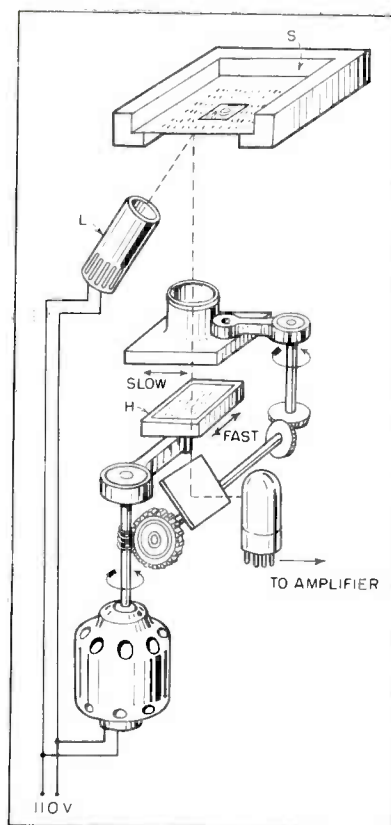

FIG. 1—Sketch of the mechanical portions of the currency selector

ing of a switch. A light *L* goes on, illuminating the copy and causing its image to be projected upon the negative.

If both copy and image are in exactly the same position as when the negative was made, the light transmitted through the negative would be almost entirely blocked. This is true because each luminous area of the image would fall on a dark area of the negative and vice versa.

Such an exact coincidence cannot be obtained in practice. However, if both the lens and negative are oscillated at right angles to one another and at frequencies differing in the ratio of about 100 to 1, there will be times when the slow oscillation of the lens brings the image into line along one coordinate. Then the fast oscillation of the negative will take care of the other coordinate and cause the periodic occlusion of the light, at a frequency double that of the fast oscillation itself.

Amplifier

An amplifier tuned to the proper frequency (double the fast oscilla-

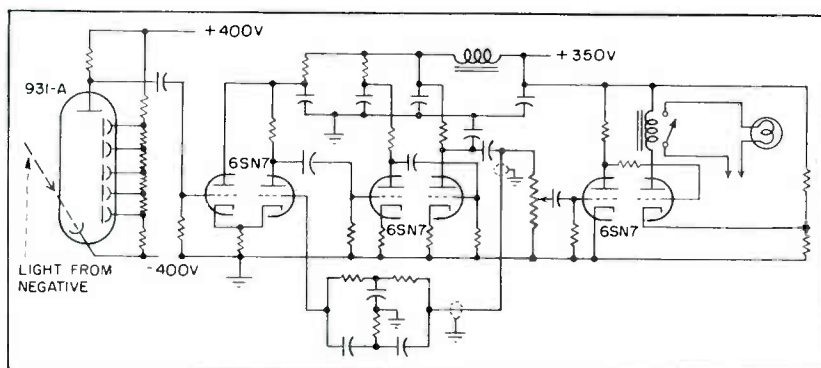

Circuit diagram of the Nomoscope

Measure Differential

Q

with

The Q METER Type 190-A

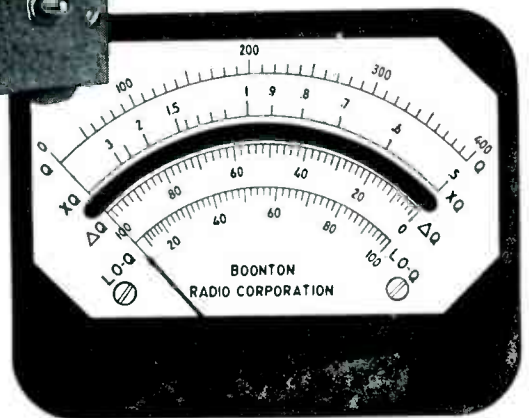

In *Designing Tuned Circuits* the effect on Q of adding capacitors, iron cores, or resistors must frequently be determined. The Q of the separate components is also often needed. These measurements made on Q Meters formerly available required the use of a small difference between two large Q values in various formulae. This led to large errors. The Q Meter Type 190-A reads the difference between the Q of a reference circuit and the Q of this circuit when new components are added. The scale that indicates this *Differential Q* has a sensitivity 4 times as great as the scale which reads Q . The accuracy and ease with which *Differential Q* can be read is greatly improved by use of the 190-A Q Meter.

The Q Meter Type 190-A has a "Lo Q" scale which reads Q down to a value of 5. The internal resonating capacitor is directly read and has a vernier arrangement for accurate reading of capacitance. The dial rotates approximately 10 times in covering the capacitance range. All readings are made on a single meter corrected for parallax.

SPECIFICATIONS

FREQUENCY COVERAGE: 20 mc to 260 mc. Continuously Variable in Four Ranges.

FREQUENCY ACCURACY: Calibrated to $\pm 1\%$.

RANGE OF Q MEASUREMENTS: 5 to 1200.

RANGE OF DIFFERENTIAL Q MEASUREMENTS: 0 to 100.

ACCURACY OF Q MEASUREMENTS: Circuit Q of 400 read directly on meter can be determined to accuracy of $\pm 5\%$ to 100 mc and to $\pm 12\%$ to 260 mc.

INTERNAL RESONATING CAPACITANCE RANGE: 7.5 mmf to 100 mmf (direct reading) calibrated in 0.1 mmf increments.

ACCURACY OF RESONATING CAPACITOR: ± 0.2 mmf to 20 mmf
 ± 0.3 mmf to 50 mmf
 ± 0.5 mmf to 100 mmf

POWER SUPPLY: 90-130 volts—60 cps (internally regulated). Power Consumption—55 watts.

(Specifications subject to change without notice)

PRICE: \$625.00 F.O.B. Factory

SINGLE, EASY-TO-READ METER WITH PARALLAX CORRECTION FOR ALL FUNCTIONS

- Q indicating voltmeter: 50 to 400.
- Multiply Q scale: 0.5 to 3.0.
- A differential Q scale for accurately indicating the difference in Q between two test circuits.
- Additional accurate expanded scale for measuring low values of Q .
- A counter type resonating capacitor dial for improved setting and reading accuracy.
- Regulated power supply for increased stability and accuracy.
- Careful design to minimize instrument loading of circuit under test.



BOONTON RADIO

BOONTON · N · J · U · S · A ·

Corporation

tion frequency) in combination with a detector, relay and phototube will cause the energizing of the appropriate circuits when the periodic fluctuations occur, indicating identity of the copy with the original.

It should be noted that the fluctuations will be present if coincidence occurs over only part of the area, provided it is a substantial

part and they will not be appreciably affected by superimposed marks. However, they will not occur if the copy "looks" like the original but is not identical to it, line for line. The fine structure of the engravings must match. These features make the principle particularly applicable to the currency selector problem since marked, torn or soiled bills will not be rejected.

F-M Detector Tuning-Indicator Circuit

BY H. B. KARPLUS

*Armour Research Foundation
Illinois Institute of Technology
Chicago, Illinois*

RECOMMENDED CIRCUITS given in the manufacturers' handbooks for a 6AL7GT tuning indicator do not make full use of all its potentialities except for a discriminator squelch-detector circuit. For the ratio-detector type of discriminator, the pattern appears very similar when a station is exactly tuned as when no station is received. This is shown in Fig. 1 and 2 of the RCA 6AL7GT description.

Pattern changes similar to Fig. 3 (on the same manufacturer's data sheet) may be obtained with a ratio detector if the indicator is connected as shown in the accompanying Fig. 1. Use is made here of the large positive potential developed at the cathode of one of the detector diodes to control the current in the indicator which is normally biased almost to cut off. Excessive plate current is prevented on strong signals by a large resistor, about 1 megohm, in series with the grid. In addition, the pattern may be shifted

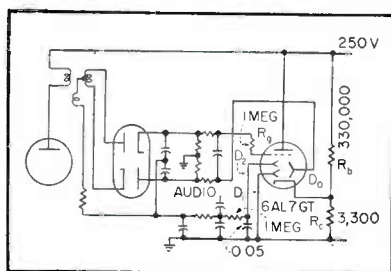

FIG. 1—Tuning eye and ratio detector

when a station is tuned by connecting the common plate D_0 to the plate of the diode as shown in Fig. 1.

Discriminator

A positive potential may be obtained from a discriminator to control the indicator tube current, from the center point of the detector load, if the cathodes of the diodes are connected to the transformer. To obviate trouble due to heater cathode capacitances, crystal diodes are recommended as shown in the accompanying Fig. 2.

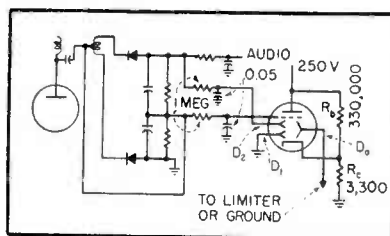

FIG. 2—6AL7 tuning eye and discriminator

In the circuits of Fig. 1 and 2, the potential divider R_0R_1 may be replaced by a large cathode resistor of around 20,000 ohms, depending on plate potential. Complete extinction is then not possible and the intensification obtained on weak stations is reduced due to the feedback effect of this resistor.

The chief advantages of the circuits described are the clear distinction between exact tuning and com-

plete detuning and also the intensity indication obtained from signals which are too weak to produce enough potential on D_0 to give a useful amount of pattern shift on the indicator.

Model Antenna Range

TO FACILITATE the measurement of antenna radiation patterns in the vertical plane, a new model antenna range has been completed by the National Bureau of Standards.

As shown in Fig. 1 and 2, the antenna range consists of an inverted V-type structure which supports a



Adjusting a test antenna on the antenna range. Antenna is the high-frequency model of one normally used at a much lower frequency

test or target transmitter about 50 feet above the ground. The model antenna to be tested is placed in the center of the ground plane beneath the V frame.

Current investigations are particularly concerned with the high-frequency band from 3 to 30 mc. At these frequencies, wavelength varies between 300 and 30 feet and measurements of full-sized antennas would require a site several thousand feet long. When the vertical-plane pattern is required, the problem becomes even more complex.

Techniques employed at NBS use the principle of electrodynamic similitude. As applied to an antenna, an equivalent performance is obtained from a model $1/n$ th as large as the prototype antenna if the operating frequency of the model is made n times the proto-

GAS OR LIGHT LIQUID
SAMPLES

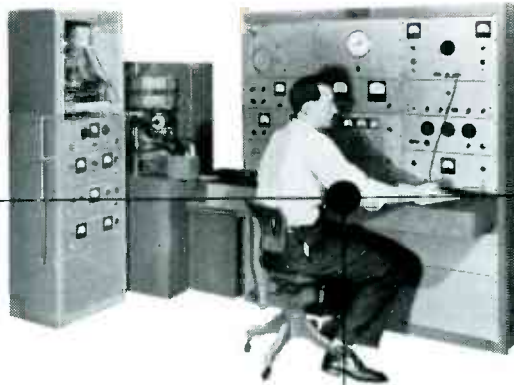
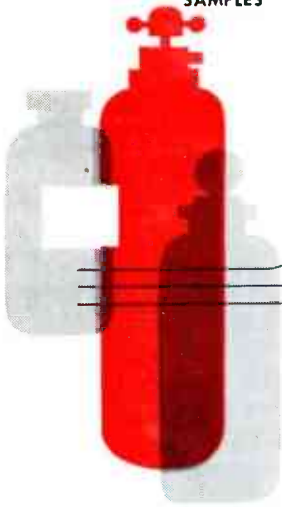

ANALYTICAL MASS SPECTROMETER



ISOTOPE - RATIO MASS SPECTROMETER

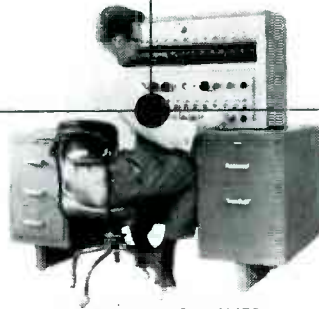

ELECTRICAL COMPUTER



this
analytical laboratory
is here to serve you



consolidated
engineering
corporation

300 No. Sierra Madre Villa
Pasadena 8, California



Since 1949 Consolidated has operated this precision analytical service—utilizing mass spectrometry under the supervision of Consolidated's experienced staff. It serves research organizations and industry having analytical problems, but where the number of samples does not justify the purchase of an instrument. Sample requirements are very small. Recommended containers are 100 cc for gas and 5 cc for liquid. Where isotope ratios are required, samples must be in the vapor phase. Cost of the service is low. For further information, request Bulletin CEC-1813.

analytical service



Analytical Instruments for Science and Industry

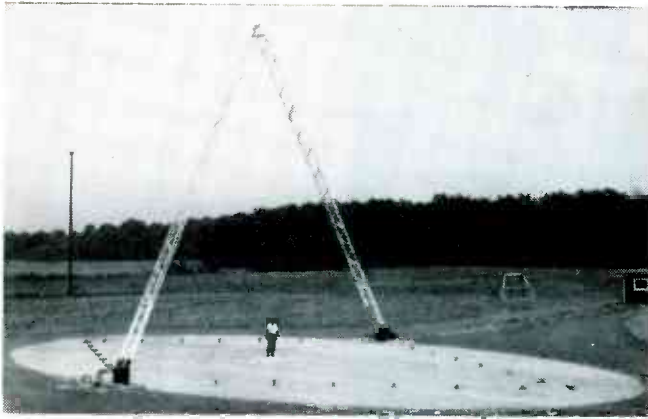

FIG. 1—Full view of the model antenna range with the target transmitter raised to the 90-deg position



FIG. 2—Checking the operating frequency of a target transmitter. Unit derives its power from wet-cell batteries

type frequency. As the model frequency is increased, the free-space wavelength is decreased proportionately. Also, the distance between the transmitting and the receiving antenna can then be reduced by the same scaling factor of n .

By using a sufficiently large scaling factor, it becomes possible to mount a target transmitter on a rigid structure, to move it over and about the model antenna under test and to obtain radiation patterns

substantially the same as the true long-distance radiation patterns of a full-scale antenna.

In addition to dividing the physical dimensions of the model by the scaling factor n and multiplying the frequency by the same factor, it is necessary to multiply the conductivity of the antenna and the ground by n . In most practical h-f antennas, the copper losses are small and the conductivity effects may be ignored without introducing any serious error.

In operation, the model antenna is located at the center of the ground plane and receives energy from the target transmitter located in the V structure. The energy intercepted by the model antenna is rectified and the signal voltage is transmitted along underground cables to a recording pen attached to an automatic pattern plotter. Synchrogenerators, connected to the axis of the V frame, transmit its position to the turntable of the pattern plotter.

Low-Frequency Adapter for Audio Oscillators

WHEN a low-frequency signal source is occasionally needed, it is feasible to build a small adapter to extend the range of an ordinary resistance-tuned audio oscillator down to a few cycles. In the case of Hewlett-Packard and similar oscillators, those models whose lowest range extends only to 20 cps are susceptible to this conversion with-

By JOSEPH HOULE
Falls Church, Va.

out disturbing their calibration on the original ranges. The adapter or range-extender is a small box with a dial, plugged in when needed.

Figure 1 shows the circuit. Pin jacks or a panel connector are installed on the oscillator, connected to the frequency-determining network as indicated. Excessive added stray capacitance should be avoided. The adapter is merely another tunable R-C network, plugged in parallel with the network in the oscillator. The range switch in the oscillator should be set on the lowest range. The impedance of the internal network is then about three orders of magnitude higher than that of the adapter; the adapter determines the frequency of oscillation. In the adapter shown, the two-gang 30,000-ohm poten-

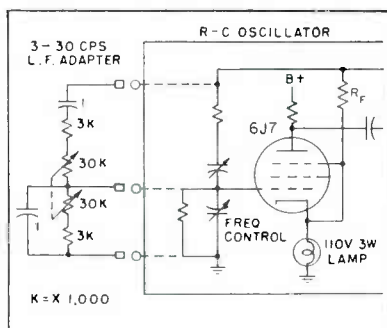

FIG. 1—Plug-in unit for adding 3 to 30-cps range to conventional R-C audio oscillator

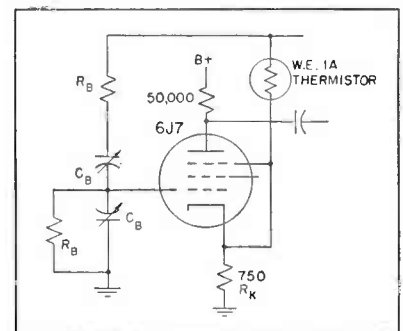

FIG. 2—Modified audio oscillator circuit using thermistor as amplitude control gives improved performance

tiometer covers the range from 3 to 30 cps. If linear potentiometers are used, the dial scale will be crowded at the high end; tapered units are better. Composition volume controls appear to track well enough, although their permanence of calibration is questionable. Capacitance tuning is not feasible.

The 110-volt, 3-watt lamp used as

CLEAN SHEETS

You can make better products from clean, smooth, flat Chase Sheet Brass and Copper. Chase sheets are free from oxide coatings, excess grease and oil. That means they are uniform in color and have a bright finish.

CMP orders. We can make favorable mill deliveries on authorized Controlled Materials orders. In many cases our warehouses can ship from stock. Your inquiries are invited.

Chase BRASS & COPPER

WATERBURY 20, CONNECTICUT • SUBSIDIARY OF KENNECOTT COPPER CORPORATION

• *The Nation's Headquarters for Brass & Copper*

Albany†	Cleveland	Kansas City, Mo.	New York	San Francisco
Atlanta	Dallas	Los Angeles	Philadelphia	Seattle
Baltimore	Denver†	Milwaukee	Pittsburgh	Waterbury
Boston	Detroit	Minneapolis	Providence	(Sales office only)
Chicago	Houston†	Newark	Rochester†	
Cincinnati	Indianapolis	New Orleans	St. Louis	

the automatic amplitude control in many commercial oscillators has easy availability as its chief advantage. The lamp resistance varies but slowly with changing current, and its range of control is quite limited. Adjustment of the series resistor R_F (Fig. 1) which determines the operating point of the lamp, is rather critical and must be tailored to the individual lamp used. The thermal time constant of these lamps is long enough to give satisfactory control down to about 5 cps, but below this frequency the lamp "follows" and distortion sets in.

A thermistor works a lot better. Its time constant is longer than that of the lamp, but its resistance is so steep a function of the heating current that it controls the amplitude, in effect, more quickly than the lamp. Its correcting action is better damped, and it can correct for larger changes in gain. The Western Electric 1A thermistor has been used successfully for amplitude control of an oscillator working down to 1 cycle.¹

Fig. 2 shows the application of the 1A thermistor to a commercial audio oscillator (Hewlett-Packard 200C). The lamp is replaced by a 750-ohm resistor, and the series resistor R_F is replaced by the 1A thermistor. No other change is necessary, and no adjustment.

While the adapter outlined above is practical without this additional modification, the addition of the thermistor is very desirable, both because of the lower distortion at the lowest frequencies, and because the constancy of amplitude is better maintained in the face of mis-tracking of the ganged potentiometers.

A low-frequency source has become almost indispensable with the advent of wide application of negative feedback to audio amplifiers. Flatness over the audible frequency range is, in fact, an indication that the frequencies beyond both ends must be explored for peaks which betray an inadequate margin against oscillation.

REFERENCES

- (1) Lawrence Fleming, Thermistor-Controlled Low-Frequency Oscillator, *ELECTRONICS*, p 97, Oct. 1946.
- (2) J. A. Becker, C. B. Green, G. L. Pearson, Properties and Uses of Thermis-

PREPAREDNESS PRODUCTION Enlists AMPHENOL

AMPHENOL RG CABLES set the standard for quality in a field where quality and dependable performance are a "must." Frequent laboratory and production tests insure uniform quality and performance. Users of Amphenol RG Cables know that they will perform as specified!

AMPHENOL RF CONNECTORS provide an efficient connecting link between coaxial cables. They feature never-failing continuity, extremely low RF loss and the assurance of a long life of sustained quality. The design, materials and finishes of each type connector are carefully chosen to give maximum performance under the required conditions.

AMPHENOL AN CONNECTORS are strong! They have a tensile strength of 53,000 pounds. Engineered to meet the rigid Army-Navy specifications these connectors insure lowest milivolt loss. The non-rotating solder pockets cut soldering time and reduce operator fatigue. Amphenol has the widest selection of AN Connectors to meet Mil-C-5015 specifications.

Now Available . . .
Catalog B-2 — A General Catalog
of Amphenol Components —
will be sent on request.

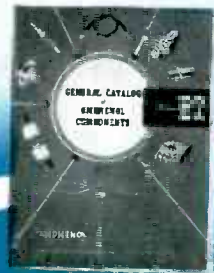

AMERICAN PHENOLIC CORPORATION
1430 SOUTH 54th AVENUE • CHICAGO 50, ILLINOIS



PHOTOGRAPHY HELPS A COSMOTRON KEEP PROTONS IN LINE

A peak power of 21,000 KVA will create the magnetic field in the cosmotron now under construction at Brookhaven National Laboratory. The design calls for whirling protons through the field of a giant doughnut-shaped magnet, over 60 feet in diameter. At every point of the protons' path along the circular quadrants and at all times during the second while the magnetic field is rising to its top value, the configuration of this field must be the same, or the protons will collide with the walls and be lost.

This monster magnet is built of laminations of $\frac{1}{2}$ " steel sheets, 8 feet high, 12 in a 5.7-ton bundle, 288 bundles in all. Each bundle had to be carefully matched to its neighbors to give the utmost overall uniformity of magnetic parameters.

Photography provided a practical solution to the matching problem. The magnetic phenomena of each

block were displayed on a cathode-ray oscillograph and photographed with a Kodak 35 camera. Five months and 8,000 oscillograms later (the shutter didn't fail once), a complete set of photographs like those seen here of the characteristics of each block made it possible to determine the position of each one in the magnet ring, to insure the most satisfactory magnetic field.

Quantitative records—full of detail, quickly made, available for reference whenever needed—are photography's contribution in a great many kinds of scientific and engineering jobs. Kodak makes a large variety of films and papers for them. Drop us a line, and we'll send you a complimentary copy of a new booklet that helps you make the best selection among them. Eastman Kodak Company, Industrial Photographic Division, Rochester 4, N. Y.

PHOTORECORDING . . . an important function of photography

Kodak
TRADE-MARK

bringing

Your Product

to market



is a full time job for... electronics

When you consider that there are more than 2,000 widely-diversified products sold to manufacturers and users of electronic equipment, the problem of bringing your product to that market — and selling it, might, at first, seem complicated. But it isn't.

Consider first how products are bought and by whom. Components and materials used in the design, testing or production of electronic equipment of all sorts are bought for engineering reasons by engineers. That this is true is obvious when one considers the extremely technical nature of the industry's products. The buying for this industry is done by men like the one shown . . . back-in-the-plant, design, development and test engineers, generally inaccessible to salesmen.

And it is their counterparts throughout industry and, of course, in communications and broadcasting who, by use of electronic equipment to solve their own design, test, production and control problems, create the markets for packaged electronic equipment.

It is for these men that **ELECTRONICS** is edited. Bringing them the up-to-the-minute electronic design, use and product information is **ELECTRONICS'** full time job. (A job it has held for over twenty years.) Because of this, they work with **ELECTRONICS** at their sides and refer to it more than to any other single source for the information they need in their work. It is for this reason that bringing your product to this market isn't as complicated as it might seem at first. **ELECTRONICS** provides a market place, the only one, in which you can reach these men who do the specifying and buying of electronics throughout industry . . . be it electronic manufacturing or general industry.



electronics

THE DIRECT ROUTE TO---

12 REGULAR ISSUES

supplying latest technical information, design and product news

A McGraw-Hill Publication • 330 West 42nd St., New York 18, N. Y.



What is YOUR PRODUCT?

With **ELECTRONICS'** blanket coverage of all industry, it doesn't matter whether your product is a material, component or piece of electronic gear — a getter or a gear train, a capacitor or a cabinet, a servo or a spring, a motor or a motor control.

Both designers and users of electronic equipment find **ELECTRONICS** their best source of information. Manufacturers find it their best source of sales to both.

It is published fact that more than 12% of all moneys being spent for defense equipment goes for electronic devices. Great sums are already allotted to hundreds of prime contractors who, in many cases, find it necessary to make time-consuming search for sub-contractors with the ability and the capacity to share in this huge business. Do they know about you?

Selling for defense is as competitive as selling to civilians. Particularly in electronic equipment, using as it does not only electronic components, but electrical and mechanical assemblies and parts, it is necessary to expose yourself to buyers. There is no speedier, surer, more economical way to do so than by selling by the written word in the advertising pages of **ELECTRONICS**.

*Further evidence is the list at the right showing some of the allied products currently being advertised successfully in **ELECTRONICS**. Positive evidence of the market offered by **ELECTRONICS** for your particular product can be obtained profitably by advertising it in **ELECTRONICS**.*



— — — A \$3,800,000,000 MARKET PLACE

ANNUAL BUYERS' GUIDE
supplying all basic product source and technical specifying data

SUCCESS STORIES

Following is a partial list of allied products currently being advertised successfully in **ELECTRONICS** . . .

- BEARINGS
- BLOWERS
- BOBBINS
- BUSHINGS
- CARBON
- CERAMICS
- COUPLINGS
- DRAFTING EQUIPMENT
- FASTENERS
- GASES
- GEAR TRAINS
- GRAPHITE
- HAND TOOLS
- HEATING TANKS
- INSULATION
- IONIZATION CHAMBERS
- LIGHTING EQUIPMENT
- METAL STAMPINGS
- METALS & ALLOYS
- MOLDINGS
- MOTORS
- MOUNTINGS
- PAPER
- PHOTOGRAPHIC EQUIPMENT
- PLASTICS
- RINGS
- SEALS
- SOLDER
- SOLDERING GUNS
- SPRINGS
- TAPES
- TUBING
- WASHERS
- WIRE & CABLE

TO MEET MIL-T-27 SPECIFICATIONS

Stancor Transformers

MUST OPERATE PROPERLY AFTER EXPOSURE TO THESE EXTREME PHYSICAL CONDITIONS

TEMPERATURE CYCLING

- Step One 1—15 minutes at 185° F (85°C).
- Step Two 2—15 minutes at room temperature.
- Step Three 3—15 minutes at -67° F (-55°C).
- Step Four 4—15 minutes at room temperature.
- Step Five 5—15 minutes in saturated salt bath.

These steps are repeated for five consecutive cycles and the unit is then subjected to a dielectric strength test at 100% of the specified voltage for five (5) seconds and the insulation resistance checked.

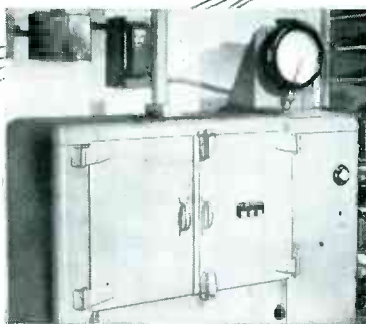

OVEN



COLD CHAMBER

HUMIDITY CYCLING

*At the end of any 5 cycles the unit is removed from the humidity chamber and subjected, for 15 minutes, to simple harmonic motion of 0.03" amplitude, with the frequency varying uniformly from 10 to 55 CPS and return to 10 CPS in one minute.

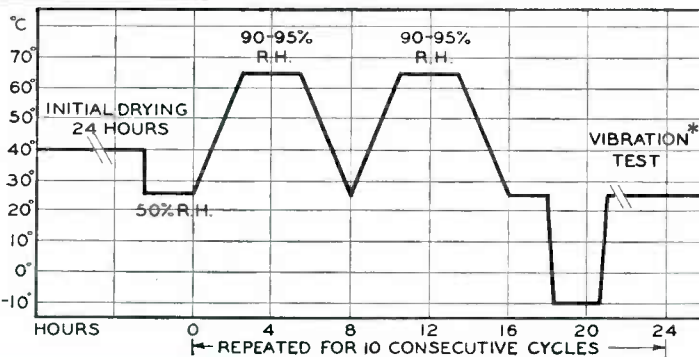

HUMIDITY CHAMBER



VIBRATION TABLE

Stancor Engineering Laboratories have complete Equipment for making these Tests.



STANDARD TRANSFORMER CORPORATION

3578 ELSTON AVENUE • CHICAGO 18, ILLINOIS

tors—Thermally Sensitive Resistors, *Electrical Engineering*, Nov. 1946.
(3) R. L. Shepherd, R. O. Wise, Frequency Stabilized Oscillator, *Proc. IRE*, 31, p 256, June 1943.

Tachometer Pickup Device

By IRVING GOTTLIEB
Mountain View, Calif.

IN INDUSTRIAL and laboratory instrumentation, it is often necessary to obtain electrical information pertaining to the angular velocity of a rotating mechanical member. A common way of meeting this requirement consists of an adaptation of the inductor-generator principle or an application of electromagnetic induction resulting from relative motion between a magnetic field and a solenoid.

The inductor-generator system makes use of a piece of permeable material attached to the rotating member. The magnetic properties of the material must differ appreciably from that of the rotating member in order to develop a good response in a nearby polarized solenoid.

In the second method, a segment of the rotating member is magnetized or a small permanent magnet is mounted thereon. An emf is induced in a nearby solenoid consisting of a winding on a soft iron core by virtue of the periodic approach and recession of the magnetic field. Still another application of magnetics involves the use of bismuth wire, the resistivity of which is a function of magnetomotive force.

With the first two methods, both

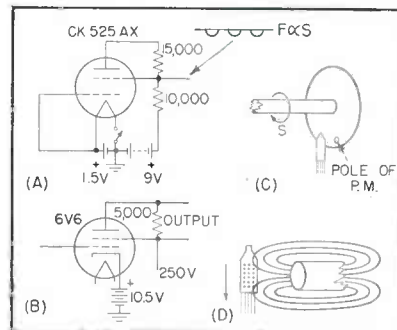
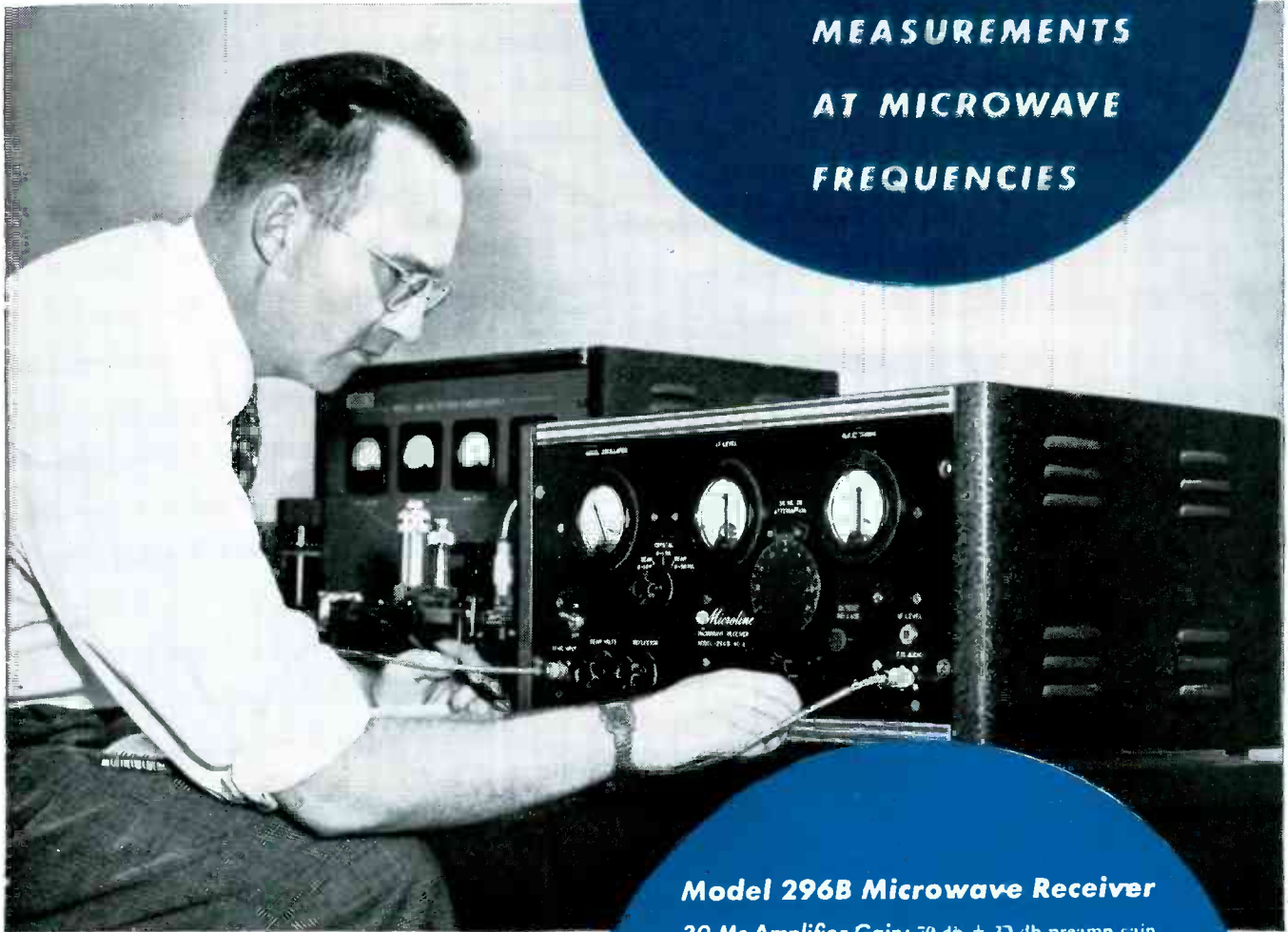

FIG. 1—Tachometer pickup device. Tachometer element circuit (A), direct-coupled amplifier (B), actual application (C) and enlarged view depicting normal component of mmf interacting with electron flow within tube (D)

The newest addition to Sperry's Microline* is Model 296B Microwave Receiver for laboratory use. This instrument is an important addition to the microwave laboratory where a good secondary standard of attenuation is required.

The versatility of Model 296B permits measurements to be made at all microwave and UHF frequencies. In addition to its use as a secondary standard of attenuation, this receiver has many other uses . . . one of the more important being antenna pattern measurements.



Model 296B consists of a 30 mc pre-amplifier, IF amplifier and precision 30 mc waveguide below cut-off attenuator. Included in the receiver is a well-regulated klystron power supply. Klystron stability is assured by self-contained, automatic frequency control circuitry.

Our Special Electronics Department will be happy to give you further information on this instrument as well as other Microline equipment.

*U. S. PAT. OFF.

SPERRY *GYROSCOPE COMPANY*
DIVISION OF THE SPERRY CORPORATION

GREAT NECK, NEW YORK · CLEVELAND · NEW ORLEANS · BROOKLYN · LOS ANGELES · SAN FRANCISCO · SEATTLE
IN CANADA — SPERRY GYROSCOPE COMPANY OF CANADA, LIMITED, MONTREAL, QUEBEC

Visit our booths 57-58-59 at the Radio Engineering Show, Grand Central Palace, March 3-6.

ELECTRONICS — February, 1952

NEW SPERRY

MICROLINE

RECEIVER FOR

ACCURATE

MEASUREMENTS

AT MICROWAVE

FREQUENCIES

Model 296B Microwave Receiver

30 Mc Amplifier Gain: 70 db + 30 db preamp gain
— 15 db insertion loss.

IF Bandwidth: 1.8 Mc.

Attenuator: Insertion loss 15 db; 40 db attenuation range with detent positions at 10 db steps.

Local Oscillator Power Supply: Beam supply 600 to 800 volts 50 ma, continuously variable, positive grounded. Reflector supply continuously variable from —10 to —500 volts with respect to cathode.

Accessories Supplied: One pre-amplifier, one pre-amplifier power cable, one klystron power cable, two 30 Mc IF cables.

Accessories Needed: Local Oscillator Klystron and a mixer.

NEW Miniature Telephone Type Relay

NEW LK RELAY

MOUNTING: End mounting for back of panel or under-chassis wiring. Interchangeable with standard "Strowger" type mounting.

COIL POWER: From 40 milliwatts to 7 watts D.C.

CONTACTS: Standard 2 amperes, special up to 5 amperes. 2 amperes up to 6 P.D.T. 5 ampere contacts (low voltage) up to 4 P.D.T. Special 20 ampere power contacts S.P.S.T., normally open, paralleled.

DIMENSIONS:

$1\frac{5}{8}$ " HIGH, $2\frac{7}{32}$ " LONG,
 $1\frac{3}{32}$ " WIDE

*These are the dimensions
for the 6 pole relay.*

*Will meet Army and Navy
aircraft specifications
as a component unit.*

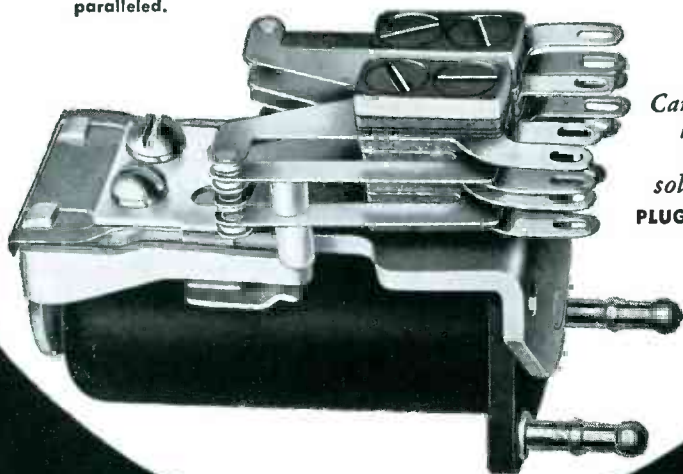

*Can be furnished
hermetically
sealed with
solder terminals.*
**PLUG-IN MOUNTING-
SPECIAL.**

SK RELAY

MOUNTING: Front of panel mounting and wiring.

COIL POWER: From 100 milliwatts to 4.5 watts D.C.

CONTACTS: Same as "LK".

DIMENSIONS: $1\frac{1}{2}$ " HIGH, $1\frac{9}{16}$ " LONG, $\frac{3}{32}$ " WIDE.

*These are the dimensions
for the 4 pole relay.*

*Will meet Army and Navy
aircraft specifications
as a component unit.*

**CAN ALSO BE FURNISHED
HERMETICALLY SEALED
WITH SOLDER TERMINALS.
PLUG-IN—SPECIAL.**

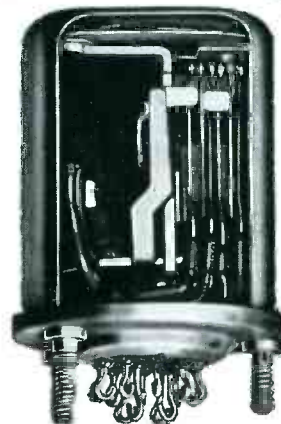

SK, HERMETICALLY SEALED

AL-132



ALLIED CONTROL CO. INC. 2 EAST END AVE., NEW YORK 21, N. Y.



“Pennies saved . . . dollars lost”

Twice in one month, when the burglar alarm went off, the police and protective service men had swarmed down on the Benedict Laundry. Each time it had been a false alarm. Inferior insulation on the alarm switch had weakened—the shorting set off the alarm. The second “run” sent two men to the hospital—a police car crashed as it rushed to the plant.

Little items, like electrical insulation, are often a matter of pennies in original costs. Failure however, can mean much in direct and indirect losses.

Guard against product breakdown with the right electrical insulation. Outstanding in the field is BH “649”, designed especially for tough jobs.

Permanently flexible and abrasion resistant it will take unusual abuse without loss of physical or dielectric properties. BH “649” can be pushed back without breakdown for ease in assembly

—spread to cover knobs and terminals
—bent or knotted—it will not lose its dielectric strength. Flexibility is constant under heat or cold. Tested from 15 minutes at 425-450°F, to 1500 hours at 220-230°F, and down to -45°C, there was no cracking or splitting. Chemical and oil resistance are additional features that help make it a must for high product protection.

BH “649” is one of a family of electrical insulations, each designed to meet a particular condition in service. Give us a few facts about your requirements—product, temperatures, voltages—we will gladly furnish samples for testing purposes.

Address Dept. E-2

Bentley, Harris Manufacturing Co.
Conshohocken, Pa.

BH *Fiberglas**
SLEEVINGS

*BH Non-Fraying Fiberglas Sleeveings are made by an exclusive Bentley, Harris process (U. S. Pat. No. 393530). “Fiberglas” is Reg. TM of Owens-Corning Fiberglas Corp.

Ease the Squeeze on clock-radio costs

with

SESSIONS Low Cost TIMERS



SESSIONS Timer, as used in
ESQUIRE Clock Radio



Only Sessions offers you all these important clock radio timer features at lowest possible prices.

The famous Sessions Clock movement has fewer moving parts and a compact subsynchronous motor that eliminates annoying "whine" of high speed gears. And the Sessions silent, long life switches are rated at 10A and 15A (UL approved). All Sessions Timers are factory tested and guar-

anteed accurate . . . and they cost less!

Ease the squeeze on your new clock radio costs by specifying Sessions Timers . . . available with choice of switching arrangements and features . . . dial and hand styling to specifications if you wish. Write for complete technical bulletin. The Sessions Clock Company, Timer Division, Department 42, Forestville, Connecticut.

Other famous name
clock radios now
equipped with
SESSIONS TIMERS:

Admiral
Jewel
Esquire
Philharmonic
Sylvania
Continental
Aircastle
Ambassador
Philco
Regal

Sessions

SWITCH TIMERS



the frequency and amplitude of the emf's developed in the solenoid are proportional to the speed of rotation of the mechanical member. If a wide range of rotational speed is to be measured, the accuracy tends to be adversely affected because the indicating device and the circuitry associated therewith generally respond to the undesired, as well as the desired, parameter. As the rotational speed becomes lower, it is increasingly difficult to induce a usable emf in a solenoid of practical dimensions. A pick-up probe made from a noninductive winding of bismuth wire is free from these shortcomings but the high thermal coefficient of resistivity of this element must be considered if accuracy is to be preserved.

The New Pickup Device

The author has applied a different type of magnetic responder which delivers constant-amplitude pulses over a rotational speed range just greater than standstill to the highest to be encountered with mechanical equipment. There is no disturbance from temperature variation. The indicating apparatus is designed and calibrated to depict rotational speed as a function of frequency.

The principle and the application thereof are illustrated in Fig. 1. A subminiature tube is used as the actual pickup element. The low velocity electrons in the interelectrode space between control and screen grids are deflected in their trajectory by a magnetic field. This will be evidenced by a reduction in screen grid and plate current.

The screen grid is used as the anode whereas, the plate, operating at a lower potential, functions in the manner of the repeller electrode in a klystron. The plate imposes a retarding field to the electrons in the region between screen grid and plate. This results in a higher screen-grid current than would otherwise be the case.

For optimum sensitivity, many electrons should reach the screen grid but their velocity should be low. By making the control grid slightly positive with respect to the filament, a large number of electrons are imparted with velocities

"And Why Should I Use Buss Fuses?"



"There's One Important Answer..."

BUSS

FUSES PROTECT YOUR GOOD NAME

Because...
BUSS FUSES

Are trouble-free—never any complaints about the operation of equipment due to faulty fuse blows.

First, each individual BUSS fuse is tested in a sensitive electronic device to make sure it will operate properly under all service conditions.

Second, the millions and millions of BUSS house fuses, industrial fuses, and fuses for the automotive and electronic industries have firmly established the unusual merits of BUSS fuses in the mind of the public.

The BUSS reputation for quality means that a distributor, dealer or consumer will know you have chosen the best fuses available.

With the cost of a fuse being so insignificant compared to the value of the equipment it protects—how can any manufacturer take a chance on any fuse except a BUSS fuse—the standard of dependable quality for more than 37 years?

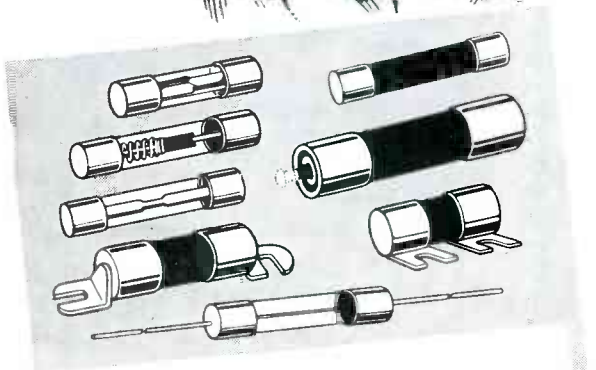

BUSS offers a complete line of fuses — for television, radio, controls, avionics and automobiles... PLUS a companion line of fuse clips, fuse blocks, and fuse holders.

Let us help you in selecting or designing the fuse or fuse mounting best suited to your needs.

BUSSMANN MFG. CO.

University at Jefferson St. Louis 7, Mo.
Division of McGraw Electric Company

USE THIS COUPON — Get all the Facts

Bussmann Mfg. Co., University at Jefferson St. Louis 7, Mo. (Division McGraw Electric Co.)

Please send me Bulletin SFB on BUSS Small Dimension Fuses and Fuse Holders.

Name _____

Title _____

Company _____

Address _____

City & Zone _____ State _____ ELRC-152

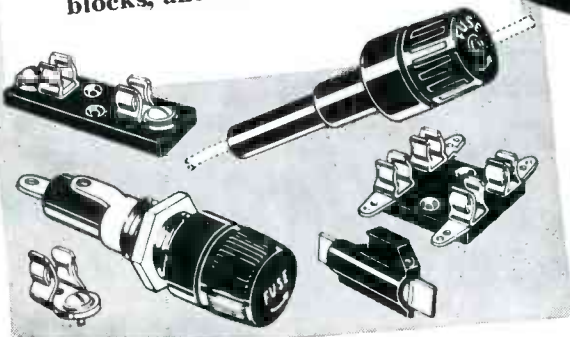



TYPE 2001-2, BASIC UNIT

Frequencies 200 to 2500 cycles. Dividers and Multipliers available for lower and higher frequencies. Miniaturized and JAN construction. Output, 6 volts.



TYPE 2005, UTILITY UNIT

Consists of Type 2001-2 and booster to provide 10 watts at 110V at precision frequencies from 50 to 500 cycles at input power frequencies of 50 to 500 cycles, 45 watts.



TYPE 2121-A, LAB. STANDARD

Outputs, 60 cycle, 0-110 Volts, 10 Watts; 120-240 cycle impulses. Input, 50-400 cycles, 45 Watts.



TYPE 2111, POWER UNIT
50 Watt output. 0-110-220V at 60 cycles, or any frequency 50 to 1000 cycles. Input, 50-100 cycles, 275 watts.

Precision FREQUENCIES

GUARANTEED
ACCURATE
TO 1 PART IN 100,000 (.001%)

THE basis of these frequency standards is an electronic fork which is temperature-compensated and hermetically sealed against humidity and barometric pressure.

Type 2001-2 and similar units are available independently. Complete instruments of our manufacture are used extensively by industry and the armed forces where unvarying, dependable high precision is required, such as for bombsights and fire control.

**WHATEVER YOUR FREQUENCY PROBLEMS,
OUR ENGINEERS ARE READY TO COOPERATE.
PLEASE REQUEST DETAILS BY TYPE NUMBER.**

WIDELY USED IN SUCH FIELDS AS:

- Aviation
- Astronomy
- Ballistics
- High-Speed Photography
- Viscosity Measurement
- Nuclear Physics
- Telemetry
- Radiation Counting
- Fluid Flow
- Chemical Reaction
- Navigation
- School Laboratories
- Industrial Research Labs.
- Accurate Speed Control

American Time Products, Inc.

580 Fifth Avenue

OPERATING UNDER PATENTS OF
WESTERN ELECTRIC COMPANY

New York 19, N. Y.

Are you missing any of these IRON CORE ENGINEERING POSSIBILITIES?



✓ Smaller tuning units ✓ Less critical materials

By providing electrostatic and electromagnetic protection over that supplied by the can, *Stackpole sleeve cores* permit use of a smaller can and enable it to be made from less critical and costly materials.

✓ Higher Q ✓ Smaller assemblies ✓ Simplified tuning

Stackpole threaded type iron cores eliminate the usual brass core screw from the field of the coil, thus greatly increasing efficiency.

✓ Better, more accurate permeability tuning

Extra density of molding pressure extends evenly over the entire length of *Stackpole side-molded cores* to assure highly uniform permeability.

End Molded ▶

Side Molded ▶



✓ No shielding problems ✓ High Q in small space

Pioneers in *cup cores*, *Stackpole* offers a complete line of standard and special self-shielding types.



There's no substitute for molded iron cores in a long list of applications—electrically, mechanically or economically!

Besides all regular styles for high, low and standard frequencies, *Stackpole* offers

full facilities for the quality-controlled production of almost any needed special type. Write for Catalog RC-8 to Electronic Components Division, *Stackpole Carbon Company*, St. Marys, Pa.

STACKPOLE

Potter & Brumfield's Super Midget Relays

SM SERIES (DC)

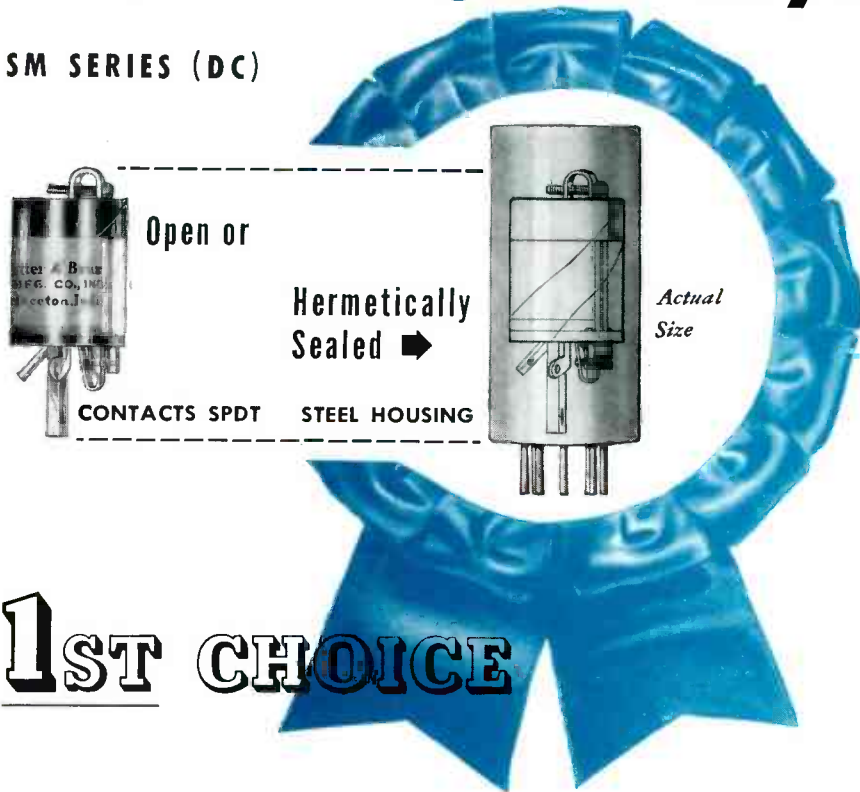

Open or

Hermetically Sealed →

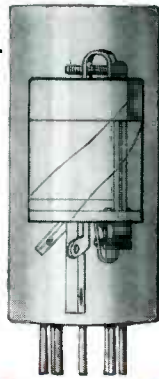

Actual Size

CONTACTS SPDT STEEL HOUSING

1ST CHOICE

... when Product Performance Requires:

Sensitivity

Operates on only 75 MW.

In spite of its small size this unique relay is capable of remarkable sensitivity. With maximum coil resistance of 10,000 ohms it will operate on only 2.75 ma while with minimum resistance of 0.15 ohm only 0.7 amp. is required. Relays for voltage operation are provided with 1/2 watt coils up to 60 volts; 1.2 watt at 115 volts. Maximum coil power permissible is 1.75 watt.

Vibration Resistance

Meets 10-G Air Force Tests

An unbelievable degree of vibration resistance has been engineered into the SM by the use of an extremely light movable element. Any type will stand 10-G test with 1/4 watt in coil and the sealed relay mounted in socket with shield will pass this test with only 0.1 watt. Also meets 25-G shock test and will stand 50-G test non-operating without damage.

Compactness

1/2 Ounce — 1/2 Cubic inch

—for the unsealed relay. Sealed in drawn steel case, this relay is same size as miniature tube and fits into 7-pin socket with or without standard hold down shield. Weight of sealed relay is only 3/4 ounce!

Another example of P & B's progressive relay engineering, the rugged, sub-miniature SM has successfully fulfilled many "tough" assignments under rigid government specifications. Has consistently proven itself in guided missile and related control applications. Send specifications for samples and quotations.

Potter & Brumfield offers a wide selection of standard and special relays for industrial and military applications—electronic, sensitive, power, miniature telephone, shock proof, motor starting, etc. Samples, recommendations and quotations promptly forwarded on request. Write today for Catalog 109.

Potter & Brumfield
Standard P & B Relays are available at
Your Local Electronics Parts Distributor

PRINCETON, INDIANA
EXPORT: 13 E. 40TH ST. N. Y.
SALES OFFICES IN PRINCIPAL CITIES

sufficient to reach the screen grid. The same number of electrons could be made to reach the screen grid by increasing the potential of that electrode. This would, however, also result in higher electronic velocity, thereby rendering the tube less responsive to magnetic fields.

The amplitude of the pulses will depend upon the field strength normal to the plane of thermionic emission. It is easy to obtain one-half volt pulses from an alnico-V permanent magnet about a quarter of an inch from the tube. With appropriate amplification, separation distances greater than an inch might even be used. The tube should be oriented about its three axes of rotation to empirically determine the most sensitive position for the particular magnetic conditions in the actual application.

Photographing R-F Modulation Patterns

By JOHN M. CARROLL

Ensign, USNR

Washington, D. C.

(on Military Leave from ELECTRONICS)

RADIATION CHARACTERISTICS of most communications transmitters may readily be studied from photographs taken of the transmitter's modulated r-f envelope. The photographs shown were taken with the incoming signal displayed along an f-m time-base which was varied to permit each particular signal to be visualized best.

As contrasted with the usual panoramic display of a video signal after detection, examination of the i-f envelope reveals details within the modulation envelope such as parasitic oscillation, sideband splat-

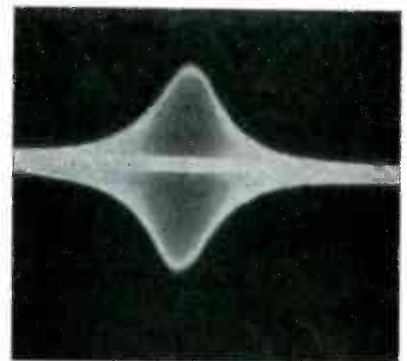

FIG. 1—Unmodulated r-f carrier

Superior Tubular Parts ... mean Superior Electronic Performance



Part of Inspection Procedure on Lockseam Nickel Cathodes as they come off the production machine. Each cathode must undergo many rigid tests before being approved.



Engineering . . . laboratory equipment for all kinds of testing, including emission characteristics of nickel cathode materials.

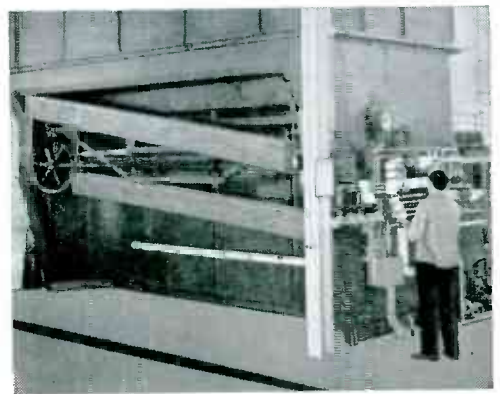

To Guard Against contamination by processing lubricants, Superior tubing is thoroughly degreased before each annealing operation.

Superior supplies disc cathodes, cups and anodes for the famous *Rauland* "Tilted Offset" Electron Gun used in peak-performance picture tubes. This new development of Rauland permits the use of a single Ion Trap magnet, bends the electron beam only once and gives the sharpest possible beam focus. The new Indicator Ion Trap reduces adjustment time to a matter of seconds, eliminates the need for mirrors or guesswork in Ion Trap adjustment. This "Double Feature" gun is a triumph of Rauland research.

But no electronic device can be better than the components of its assembly. That's why Rauland and so many other electronics manufacturers specify Superior tubular parts.

Here at Superior we combine production know-how, research facilities and engineering experience to produce tubular parts, in many forms and metals, each designed to do tough electronics jobs better. We have specialty equipment for the high speed production of anodes, cups, cathodes, grid cylinders and many other parts for television and cathode ray gun structures. If you are not now a customer of Superior it will pay you to check on the many ways in which we can serve you. Write for information — no obligation of course. Superior Tube Company, 2500 Germantown Ave., Norristown, Pennsylvania.

Which Is The Better For Your Product . . .

SEAMLESS . . . ? The finest tubes that can be made. Standard production is .010" to .121" O.D. inclusive, with wall thicknesses of .0015" to .005". Cathodes with larger diameters and heavier walls will be produced to customer specification.

Or LOCKSEAM* . . . ? Produced directly from thin nickel alloy strip stock, .040" to .100" O.D. in standard length range of 11.5 mm to 42 mm. Round, rectangular or oval, cut to specified lengths, beaded or plain.

Superior
THE BIG NAME IN SMALL TUBING

All analyses .010" to 1/4" O.D.
Certain analyses (.035" max. wall) Up to 1 1/4" O.D.

*MFD UNDER U. S. PATS. SUPERIOR TUBE COMPANY • Electronic Products for export through Driver-Harris Company, Harrison, New Jersey • Harrison 6-4800

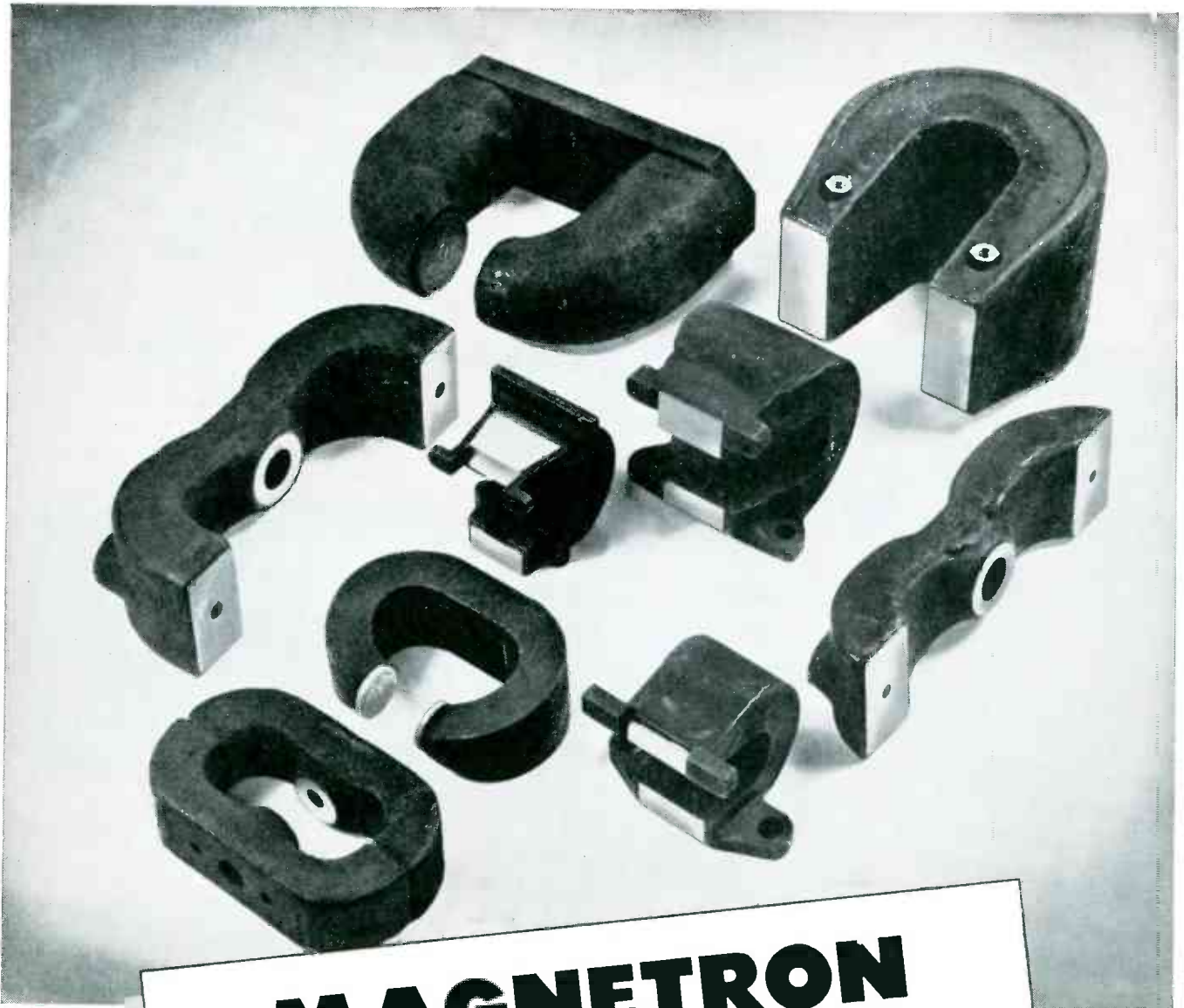

MAGNETRON PERMANENT MAGNETS AND ASSEMBLIES

with

- ☆ **Die Cast Aluminum Jackets**
- ☆ **Sand Cast Aluminum Jackets**
- ☆ **Celastic Covers**

Complete assemblies with Permendur, steel or aluminum bases, inserts and keepers as specified. Magnetized and stabilized as required.



THE ARNOLD ENGINEERING COMPANY

SUBSIDIARY OF ALLEGHENY LUDLUM STEEL CORPORATION

General Office & Plant: Marengo, Illinois

In this panel are illustrated standard models of HELIPOT multi-turn and single-turn precision potentiometers—available in a wide range of resistances and accuracies to fulfill the needs of nearly any potentiometer application. The Beckman DUODIAL is furnished in two designs and four turns-ratios, to add to the usefulness of the HELIPOT by permitting easy and rapid reading or adjustment.



MODELS A, B, & C HELIPOTS
 A—10 turns, 46" coil, 1-13/16" dia., 5 watts—resistances from 10 to 300,000 ohms.
 B—15 turns, 140" coil, 3-5/16" dia., 10 watts—resistances from 50 to 500,000 ohms.
 C—3 turns, 13-1/2" coil, 1-13/16" dia., 3 watts—resistances from 5 to 50,000 ohms.

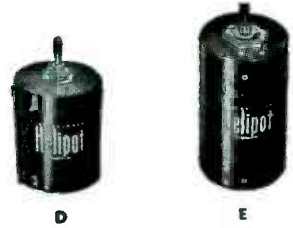

MODELS D AND E HELIPOTS
 Provide extreme accuracy of control and adjustment, with 9,000 and 14,400 degrees of shaft rotation.
 D—25 turns, 234" coil, 3-5/16" dia., 15 watts—resistances from 100 to 750,000 ohms.
 E—40 turns, 373" coil, 3-5/16" dia., 20 watts—resistances from 200 ohms to one megohm.



MODELS F, G AND J PRECISION SINGLE-TURN POTENTIOMETERS
 Feature both continuous and limited mechanical rotation, with maximum effective electrical rotation. Versatility of designs permit a wide variety of special features.
 F—3-5/16" dia., 5 watts, electrical rotation 359°—resistances 10 to 100,000 ohms.
 G—1-5/16" dia., 2 watts, electrical rotation 356°—resistances 5 to 20,000 ohms.
 J—2" dia., 5 watts, electrical rotation 357°—resistances 50 to 50,000 ohms.

LABORATORY MODEL HELIPOT

The ideal resistance unit for use in laboratory and experimental applications. Also helpful in calibrating and checking test equipment. Combines high accuracy and wide range of 10-turn HELIPOT with precision adjustability of DUODIAL. Available in eight stock resistance values from 100 to 100,000 ohms, and other values on special order.



MODELS R AND W DUODIALS
 Each model available in standard turns-ratios of 10, 15, 25 and 40 to 1. Inner scale indicates angular position of HELIPOT sliding contact, and outer scale the helical turn on which it is located. Can be driven from knob or shaft end.
 R—2" diameter, exclusive of index.
 W—4-3/4" diameter, exclusive of index. Features finger hole in knob to speed rotation.

FOR PRECISION POTENTIOMETERS

come to **Helipot**

...world's largest manufacturer of such equipment!

For many years The HELIPOT Corporation has been a leader in the development of advanced types of potentiometers. It pioneered the *helical* potentiometer—the potentiometer now so widely used in computer circuits, radar equipment, aviation devices and other military and industrial applications. It pioneered the *DUODIAL**—the turns-indicating dial that greatly simplifies the control of multiple-turn potentiometers and other similar devices. And it has also pioneered in the development of many other unique potentiometric advancements where highest skill coupled with ability to mass-produce to close tolerances have been imperative.

In order to meet rigid government specifications on these developments—and at the same time produce them economically—HELIPOT* has perfected unique manufacturing facilities, including high speed machines capable of winding extreme lengths of resistance elements employing wire even less than .001" diameter. These winding machines are further supplemented by special testing facilities and potentiometer "know-how" unsurpassed in the industry.

So if you have a problem requiring precision potentiometers your best bet is to bring it to The HELIPOT Corporation, world's largest manufacturer of such equipment. A call or letter outlining your problem will receive immediate attention!

*Trade Marks Registered

The versatility of the potentiometer designs illustrated above permit a wide variety of modifications and features, including double shaft extensions, a multiplicity of taps, variation of both electrical and mechanical rotation, special shafts and mounting bushings, high and low temperature operation, and close tolerances on both resistance and linearity. Examples of potentiometers modified for unusual applications are pictured at right.

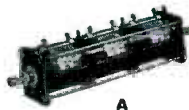

3-GANGED MODEL A HELIPOT AND DOUBLE SHAFT MODEL C HELIPOT
 All HELIPOTS, and the Model F Potentiometer, can be furnished with shaft extensions and mounting bushings at each end to facilitate coupling to other equipment. The Model F, and the A, B, and C HELIPOTS are available in multiple assemblies, ganged at the factory on common shafts, for the control of associated circuits.



MULTITAPPED MODEL B HELIPOT AND 6-GANGED TAPPED MODEL F
 This Model B Helipot contains 40 taps, placed as required at specified points on coil. The Six-Gang Model F Potentiometer contains 19 additional taps on the middle two sections. Such taps permit use of padding resistors to create desired non-linear potentiometer functions, with advantage of flexibility, in that curves can be altered as required.

THE Helipot CORPORATION, SOUTH PASADENA 2, CALIFORNIA

Field Offices: Boston, New York, Philadelphia, Rochester, Cleveland, Detroit, Chicago, St. Louis, Los Angeles and Fort Myers, Florida. Export Agents: Fratham Co., New York 16, N.Y.

TODAY

there is a new
and much better way
to moisture-proof important
electrical components

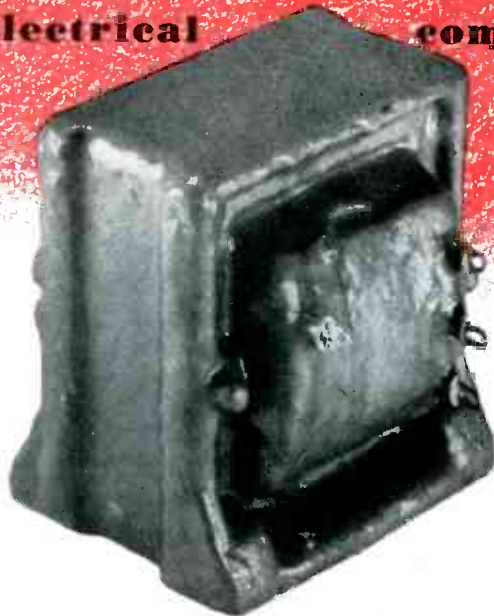

FOSTERITE*

developed by Westinghouse

applied by **WHEELER**

Service under military and naval field conditions has sharply emphasized the importance of adequate moisture-proofing for transformers, coils and related components in many types of electrical apparatus. FOSTERITE* materials and methods, developed by Westinghouse and applied by WHEELER under license, now provide an economical, practical and highly satisfactory solution to such problems. FOSTERITING, in effect, completely seals and encapsules each unit in a neutral, stable, permanent moisture-proof jacket.

FOSTERITED Wheeler Components will meet exacting military and industrial specifications with full assurance of long-range performance. The process can be applied either to your own components shipped to our plant or to components developed by our engineers to meet your specifications.

Capacity will naturally be limited. We suggest you get in touch with us at once.

*©Westinghouse Elec. Mfg. Co.



WHEELER

MAKES THESE PRODUCTS A *Specialty*

THE WHEELER INSULATED WIRE CO., INC., 1101 EAST AURORA ST., WATERBURY 20, CONN.

8WH52

Division of The Sperry Corp.

- MAGNET WIRE
- COILS
- COMMUNICATIONS EQUIPMENT
- TRANSFORMERS

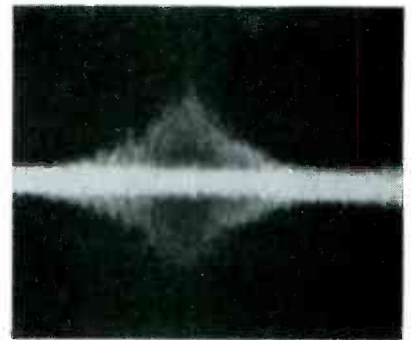

FIG. 2—Carrier with spurious modulation

ter, unwanted f-m due to oscillator instability and other spurious emission. Some of these details are lost altogether in the process of detection.

The pattern of an unmodulated carrier is shown in Fig. 1. The bandwidth is somewhat exaggerated in all such sweeping panoramic signal presentations due to the finite time, in this case 1/30 sec, taken for the f-m time-base sweep. The carrier appears to be free of undesired modulation. It produces a clear note when heterodyned with the receiver beat-frequency oscillator.

Figure 2 was also taken of a c-w carrier. However, this signal would be described as producing a rough note when heterodyned with the bfo and its spurious modulation content is readily apparent from the photograph. The appearance of broadcast music is shown in Fig. 3.

A frequency-shift keyed radiotelegraph signal is shown in Fig. 4. In this type of frequency modulation, the shift in the frequency of the r-f carrier corresponds to the 'space' and 'mark' intervals of

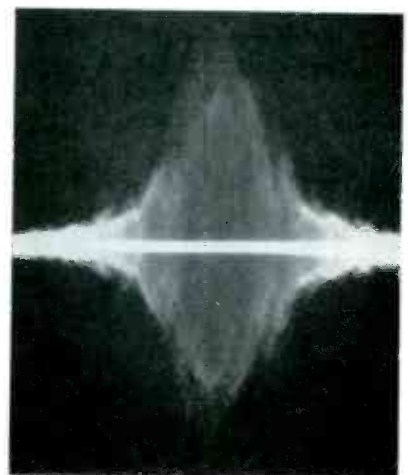

FIG. 3—Broadcast music



Announcing

The new RCA WV-87A *Master* VoltOhmyst*

\$112.50 Suggested User Price

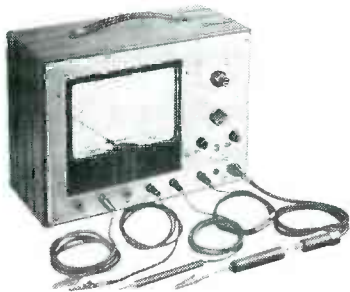

Measures... (Full-scale ranges)

DC VOLTAGE: 0 to 1.5, 5, 15, 50, 150, 500, 1500 volts
 PEAK-TO-PEAK VOLTAGE: 0 to 4, 14, 42, 140, 420, 1400, 4200 volts
 RMS VOLTAGE: 0 to 1.5, 5, 15, 50, 150, 500, 1500 volts
 RESISTANCE: 0 to 1000 megohms in seven overlapping ranges
 DC CURRENT: 0 to 0.5, 1.5, 5, 15, 50, 150, 500 milliamperes; 0 to 1.5, 15 amperes

Sold Complete—with the following Probes and Cables

- Direct Probe and Cable
- DC Probe
- Ohms Cable and Probe
- + Current Cable (Red)
- - Current Cable (Black)
- Ground (Case) Cable

Accessory Probes Available on Separate Order

- ✓ WG-264 Crystal-Diode Probe for measuring ac voltages at frequencies up to 250 Mc.
- ✓ WG-289 High-Voltage Probe, with WG-206 Multiplier Resistor, for increasing dc-voltage range to 50,000 volts and input resistance to 1100 megohms.

FEATURING an 8½" meter, the new WV-87A Master VoltOhmyst is really the master of every testing application. Its peak-to-peak scales are particularly useful for television, radar, and other types of pulse work.

The WV-87A measures dc voltages accurately in high-impedance circuits, even with ac present. It also reads rms values of sine waves and the peak-to-peak values of complex waves or recurrent pulses, even in the presence of dc.

Like all RCA VoltOhmysts, the WV-87A features ±1% multiplier and shunt resistors, a ±2% meter movement, high-input resistance, zero-center scale adjustment for discriminator alignment, dc polarity-reversing switch, and a sturdy metal case for good rf shielding.

On direct-current measurements, extremely low-

meter resistance gives an average voltage drop of only 0.3 volt for full-scale readings on all ranges. Nine overlapping ranges provide dc readings from 10 microamperes to 15 amperes.

An outstanding feature is its usefulness as a television signal tracer... made possible by its high ac input resistance, wide frequency range, and direct reading of peak-to-peak voltages.

The RCA WV-87A Master VoltOhmyst has the accuracy and stability for laboratory work. Its large, easy-to-read meter also makes it especially desirable as a permanently mounted instrument in the factory and repair shop.

For complete information on the WV-87A, see your RCA Test Equipment Distributor or write RCA, Commercial Engineering, Section BX42, Harrison, New Jersey.

*Reg. U. S. Pat. Off.

Get complete details today from your RCA Test Equipment Distributor.



RADIO CORPORATION of AMERICA
 TEST EQUIPMENT
 HARRISON, N. J.

KLEINS

*Quality pliers for radio-
television-amplifier work*



**No. 301 KLEIN
LONG NOSE PLIERS**

Extra long reach of jaws permits getting into difficult places. Hardened and tempered to assure positive grip at point. Available in 5, 6 and 7 inch lengths.

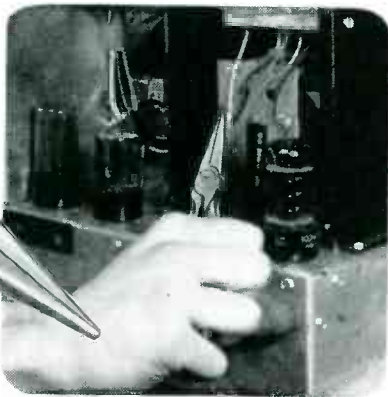

**No. 202 KLEIN NARROW
NOSE OBLIQUE CUTTING
PLIERS**

One of the most useful tools in your kit. Narrow head permits use in confined places. Individually honed knives meet accurately at all points and stay sharp. Available in 5 or 6 inch sizes.



• There is a Klein Plier made for every job in wiring radios, television or sound system amplifiers. Long nose pliers that assure a tight grip even in confined spaces. Keen edged cutters that stay sharp even after continued service. Flat nose pliers, duck bill pliers, curved nose pliers—many types and sizes to meet every wiring need. By having a full selection of these quality tools, you will save valuable time in any wiring work.

This Klein Pocket Tool Guide gives full information on all types and sizes of Klein Pliers. A copy will be sent without obligation.



ASK YOUR SUPPLIER

Foreign Distributor
International Standard
Electric Corp.
New York



"Since 1857"

Mathias KLEIN & Sons
Established 1857 Chicago, Ill., U.S.A.

3200 BELMONT AVENUE, CHICAGO 18, ILLINOIS

ENGINEERS DESIGNERS PHYSICISTS

THE Aerophysics & Atomic Energy Research Division of North American Aviation, Inc., offers unparalleled opportunities in Research, Development, Design and Test work in the fields of Long Range Guided Missiles, Automatic Flight and Fire Control Equipment and Atomic Energy. Well-qualified engineers, designers and physicists urgently needed for all phases of work in

Supersonic Aerodynamics,
Preliminary Design & Analysis,
Electronics,
Electro-Mechanical Devices,
Instrumentation,
Flight Test,
Navigation Equipment,
Controls,
Servos,
Rocket Motors,
Propulsion Systems,
Thermodynamics,
Airframe Design,
Stress & Structures.

Salaries Commensurate with training & experience.
Excellent working conditions.
Finest facilities and equipment.
Outstanding opportunities for advancement.

Write now—Give complete resume of education, background and experience

PERSONNEL DEPT.
AEROPHYSICS & ATOMIC ENERGY
RESEARCH DIVISION

**NORTH AMERICAN AVIATION
INC.**

12214 LAKEWOOD BLVD.
DOWNEY, CALIFORNIA

Hi-Q* SERVES NATIONAL DEFENSE

Wherever Electronics Guide Them Home

The amazing and intricate science of electronics has provided new eyes and ears to bring our airmen straight home from anywhere . . . to sight a target many horizons beyond the span of human vision. On land and sea, electronics likewise has become a vital keystone in national defense.

And wherever you find electronics, you'll find Hi-Q . . . Small Ceramic Disk Capacitors, for example, of both the by-pass and temperature compensating types. Tubulars, perhaps . . . Plates or the new High Voltage units. And wherever you find Hi-Q you'll find unerring dependability, rigid adherence to specifications and tolerances, and long life.

Whether your needs are for standard or specially designed components, Hi-Q engineering and production keenness can meet your most exacting requirements.



Specializing in ceramic capacitors, Hi-Q has developed a complete line of Temperature Compensating Disk Capacitors with a capacity range from 475 mmf to .3 mmf and standard tolerances of $\pm 5\%$, 10% or 20%. For applications requiring a large gradient of capacity vs. temperature Hi-Q Extended Temperature Compensating Disk Capacitors are available. These together with Hi-Q By-pass Disk Capacitors give you one source of supply for all ceramic Disk type capacitors. Write for New Engineering Bulletin on Disks.

*Trade Mark Reg. U.S. Pat. Office

Electrical Reactance Corp.

SALES OFFICES: New York, Philadelphia, Detroit, Chicago, Los Angeles
PLANTS: Olean, N. Y., Franklinville, N. Y., Jessup, Pa., Myrtle Beach, S. C.



OLEAN, NEW YORK

JOBBERS — ADDRESS

740 Belleville Ave., New Bedford, Mass.

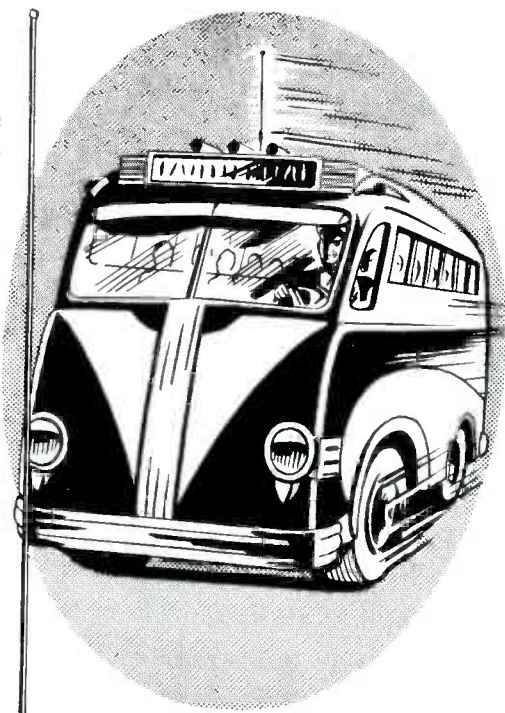

AN OLD PROBLEM ••• A NEW SOLUTION

by **WARD**

PROBLEM: One of greater durability for police, bus and truck two-way communication antennas . . . too many antennas being broken from overhanging branches and obstructions because of antenna height . . . high repair costs . . . vehicles laid up . . . efficiency impaired.

SOLUTION: WARD engineers came through with the answer in the form of the "coil-spring" SPPC-88 . . . the perfect answer for all roof-top mounts where reliable communication is important.

DATA: The SPPC-88 is equipped with two springs. One, of heavy steel, mounted to the vehicle surface . . . the other, a combination spring and electrical coil. The antenna can be deflected to a horizontal position protruding only four inches without breakage or deformation. If you would like further information, write us.

This is typical of the many antenna problems that are being solved by WARD, everyday. If you have an antenna need . . . contact WARD — for WARD has the experience to solve your problem and the facilities to produce it economically, meeting your delivery requirements.



WARD

WORLD'S OLDEST AND LARGEST
EXCLUSIVE MANUFACTURER OF
ANTENNAS

THE WARD PRODUCTS CORPORATION

Division of The Gabriel Co.

1523 East 45th Street • Cleveland 3, Ohio

In Canada: Atlas Radio Corp., Ltd., Toronto, Ont.

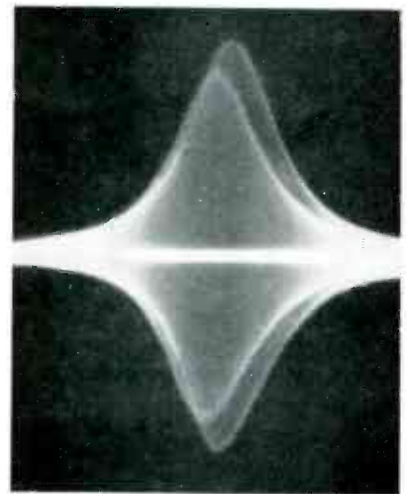

FIG. 4—Frequency-shift-keyed radiotelegraph

radio-printer code. In this case, the frequency shift is 850 cps.

The appearance of a more complex signal is shown in Fig. 5. This type of modulation is known as double single-sideband. To the left of the carrier, which is suppressed 60 db, are 12 audio tones each 170 cps apart in frequency. Each adjacent pair of tones constitutes a two-tone keyed radio-printer channel. To the right of the carrier are the lower sidebands of the narrow-band voice channel associated with the system. The 440 cps tone modulation pattern of standard frequency station WWV is shown in Fig. 6.

The signal is received on a standard communications-type receiver coupled to a panoramic intercept adapter which provides an f-m sweep to sample the signal in frequency in step with the oscilloscope time-base. Exposure for the photographs is 1/5 second at f 3.5.

The 455-kc i-f signal is taken off the plate of the receiver mixer tube. This avoids reduction in bandwidth due to receiver i-f selectivity and approaches the ideal condition for this type of work which would be a receiver with a wide-open front end. The panoramic r-f amplifier has a 180-kc passband.

The panoramic f-m oscillator is swept from 581 to 781 kc at a 30-cps rate. The panoramic i-f amplifier is sharply tuned to 226 kc. Thus, the 200-kc passband centered about 455 kc is sampled 30 times per second. A 30-cps sawtooth voltage, which also provides the

Three New Products Developed by LABORATORY for ELECTRONICS, INC.

The LFE Model 401 Oscilloscope is a high gain, wide band, versatile general purpose instrument capable of quantitative measurements of high and low speed electrical phenomena. It is perfectly suited for the precise examination of pulse wave-forms and transient phenomena, in addition to customary oscilloscope applications.

OUTSTANDING FEATURES

- High sensitivity
- Excellent transient response
- Triggered and recurrent linear sweeps
- Continuously adjustable precision sweep delay
- Signal input line terminations
- Functionally grouped and colored control knobs



Model 401 OSCILLOSCOPE



MERCURY DELAY LINES

LFE Mercury Delay Lines meet severe military requirements and are precision built under controlled conditions. Used for storage of information, comparison of two sets of information, correlations and sequential timing devices, they are the smallest, most compact lines available. Currently recognized as a foremost supplier of mercury delay lines, LFE furnishes a wide range of delays and assures quick delivery.



Model 101 MAGNETOMETER

The Pound Magnetometer is a device for accurately measuring magnetic field strength using the principle of nuclear resonance. Accuracy of measurement is limited only by the accuracy of the frequency measuring equipment. Because of its simplicity, accuracy and wide range, the Model 101 Magnetometer is ideal for engineering and research organizations working with magnetism.

*See these three new products demonstrated at the
New York, I. R. E. Show, fourth floor, booth 461*



LABORATORY
for
ELECTRONICS, INC.

43 LEON STREET BOSTON 15, MASS.

Here's why those in the know

— demand

CANNON SOLENOIDS

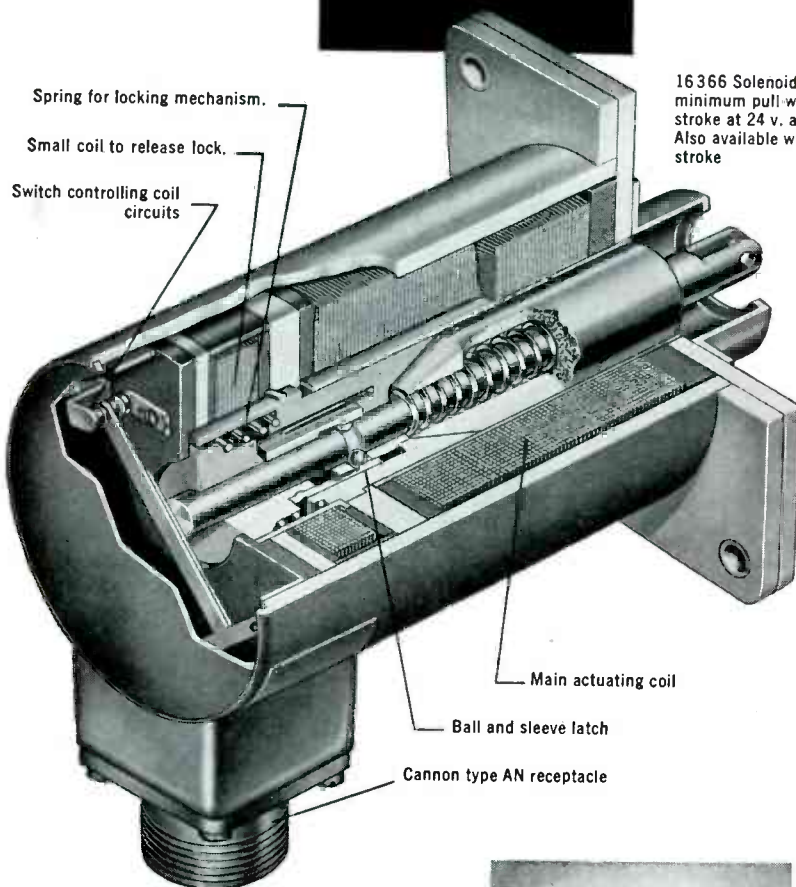

16366 Solenoid — 18.7 lb. minimum pull with 1/2" stroke at 24 v. at 170° F. Also available with 1-1/8" stroke

Here's a special purpose Cannon D.C. Solenoid, #16366 for aircraft. Design and safety conditions require that the armature lock in the actuated position for an indefinite time, without relying on a continuous flow of current.

The ingenious ball-and-sleeve latch locks the armature as the main coil circuit is broken through the built-in switch. When current is applied to the smaller coil, motion of the sleeve releases the main armature. Study of the drawing shows how a smooth-acting, positive lock is accomplished.

This is one of more than 60 different Cannon D.C. Solenoids built around 18 basic coils for either continuous or intermittent service. Write for Solenoid Bulletin free on request.

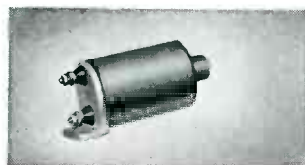

#1154 an intermittent service solenoid, 12v, D.C.—10.5 amps.—stroke 9/32", weight 13 oz.



#4440 a continuous service solenoid, 24v, D.C.—3.6 amp. (starting) .42 amp. (holding)—stroke 3/8" weight 16 oz.



#11790 a continuous service solenoid, 24v, D.C.—3.6 amp. (starting) .42 amp. (holding)—stroke 3/8" weight 15.5 oz.

CANNON ELECTRIC

Since 1915

CANNON ELECTRIC COMPANY
LOS ANGELES 13, CALIFORNIA

Factories in Los Angeles, Toronto, New Haven. Great Lakes Division, Benton Harbor, Mich. Representatives in principal cities. Address inquiries to Cannon Electric Co., Dept. B-120, P.O. Box 75, Lincoln Heights Sta., Los Angeles 31, Calif.



KENYON TRANSFORMERS



FOR STANDARD AND SPECIAL APPLICATIONS



For more than 25 years, Kenyon has led the field in producing premium quality transformers. These rugged units are (1) engineered to specific requirements (2) manufactured for long, trouble-free operation (3) meet all Army-Navy specifications.



KENYON TRANSFORMERS FOR

- J A N Applications
- Radar
- Broadcast
- Atomic Energy Equipment
- Special Machinery
- Automatic Controls
- Experimental Laboratories



Write for details

KENYON TRANSFORMER CO., Inc.
840 Barry Street, New York 59, N. Y.

Got a
really tough
capacitor
network
problem for us?

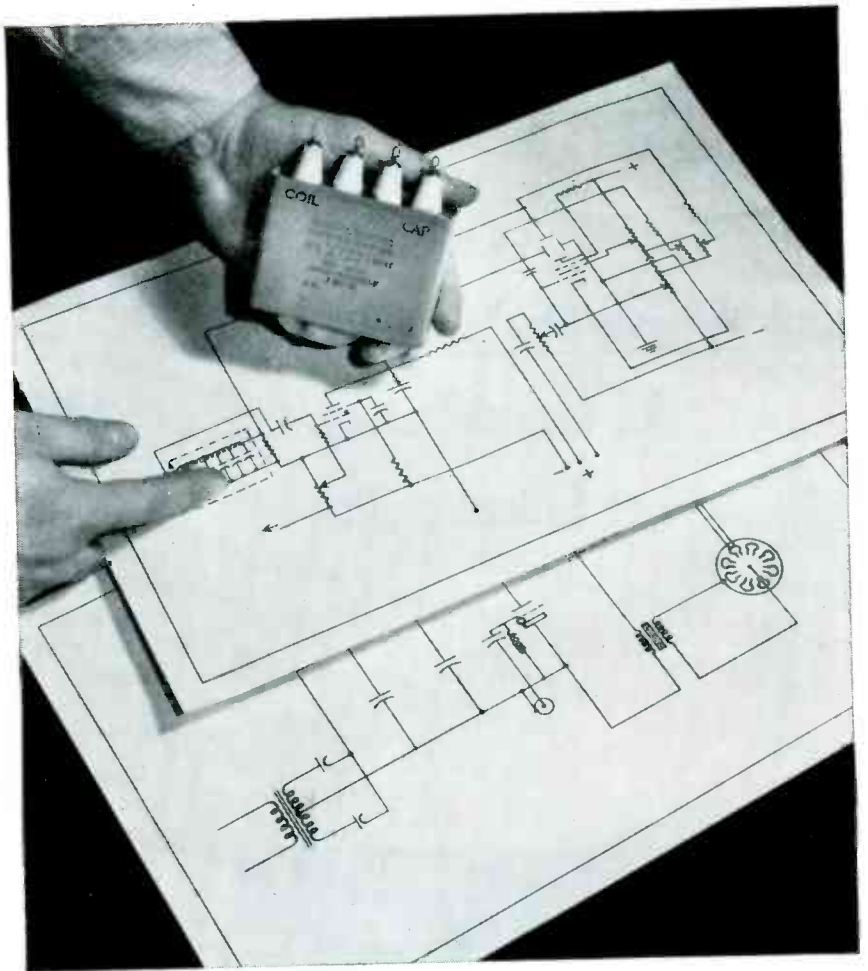

...let our network designers help you solve it!

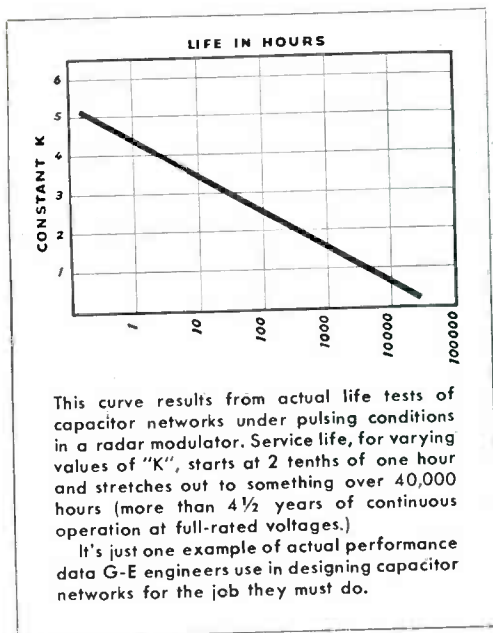

Whether your problem deals with guided missiles—aircraft—land or sea radar equipments, General Electric application and design engineers can help you solve it. We've designed and built capacitor networks for every type of pulse radar equipment since the inception of radar.

Take service life for example. You can specify a service life of 10,000 hours—or just 60 seconds. And we'll deliver pulse networks to match your requirements. Here's why:

Since 1944 General Electric has been running continuous life tests on many types of networks. We've established life limitations, under varying conditions of temperature and voltage, for all types of dielectrics, bushings, materials for coil forms and treating processes.

Let us use this store of information and experience to solve your capacitor network problems. Your inquiry addressed to your nearest Apparatus Sales Office, or to Capacitor Sales Division, General Electric Company, Hudson Falls, N. Y. will receive prompt attention.

General Electric Company, Schenectady 5, New York.

GENERAL  **ELECTRIC** 407-308

a versatile
High Vacuum "Packaged System"
for leak detecting,
gas filling, sealing

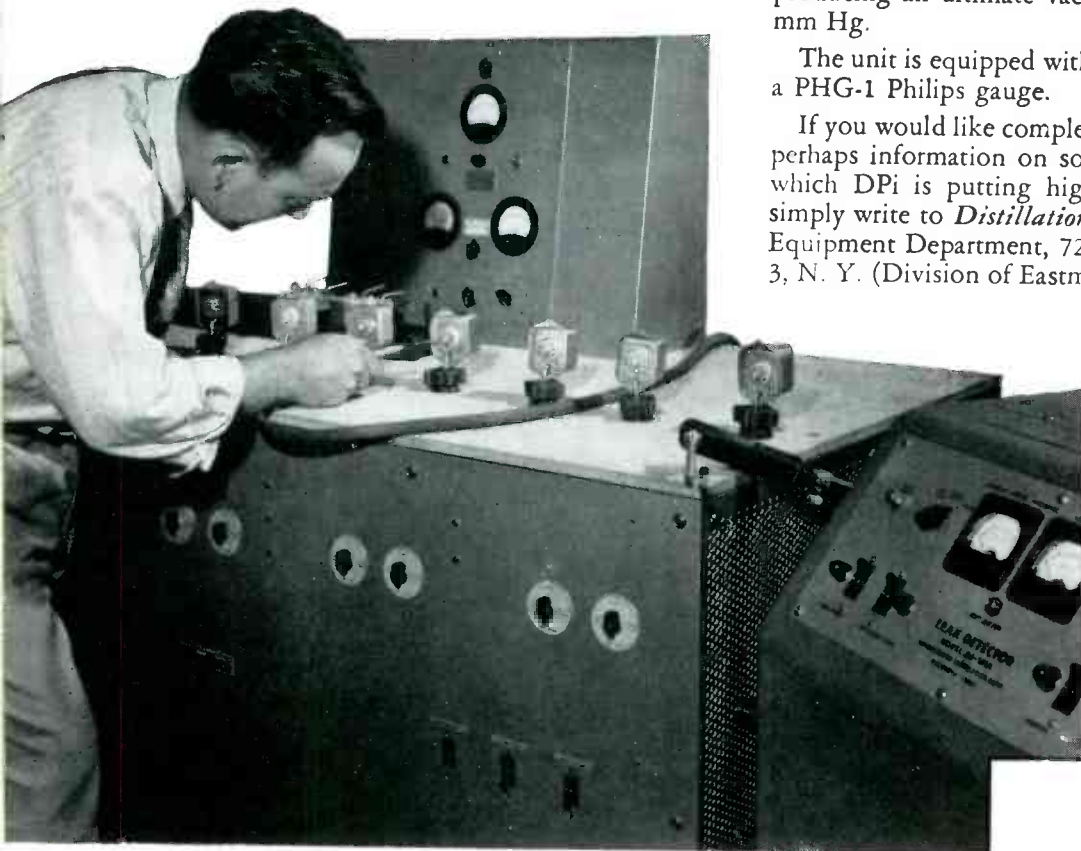

● **DPI's 10-PORT VACUUM MANIFOLD SYSTEM** is greatly improving the efficiency of processing sealed relays, small containers, and delicate mechanisms in the electronics industries.

Used specifically for leak detecting, gas filling, and sealing, it is particularly effective in checking units for microscopically small leaks. (A Consolidated Leak Detector, which is connected to the system, can sound an alarm for a leak so small that a thimbleful of air would take 30 years to get through.)

The Vacuum Manifold System is a completely contained "packaged unit," designed to operate from any 110-volt, 60-cycle line capable of handling 35 amperes.

Two mechanical pumps serve as the roughing and the backing pumps for the unit. The roughing pump evacuates the ports to a pressure within the operating range of the diffusion pump. The backing pump maintains a forepressure on the diffusion pump that is well below the required pressure for efficient diffusion pump operation. And three electrically energized solenoid valves on each port of the manifold permit continuous operation of the diffusion pump during the entire processing cycle.

This diffusion pump, DPI model MC-275, is capable of producing an ultimate vacuum of approximately 5×10^{-5} mm Hg.

The unit is equipped with a two station Pirani gauge and a PHG-1 Philips gauge.

If you would like complete technical data on this unit, or perhaps information on some of the many other ways in which DPI is putting high vacuum at industry's service, simply write to *Distillation Products Industries*, Vacuum Equipment Department, 727 Ridge Road West, Rochester 3, N. Y. (Division of Eastman Kodak Company).

DPI's 10-Port Vacuum Manifold System in use at Barber-Colman Company, Rockford, Illinois.

DPI

**high vacuum research
and engineering**

Also... vitamins A and E... distilled monoglycerides... more than 3400 Eastman Organic Chemicals for science and industry

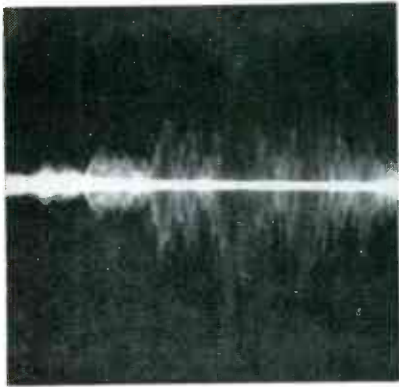

FIG. 5—Double single-sideband suppressed carrier

horizontal time base for the panoramic scope, is used to vary the transconductance of the reactor tubes across the f-m oscillator tank. The 30-cps sawtooth generator is synchronized with the power-line frequency.

The Y-axis amplifier of the oscilloscope has substantially flat video response from 20 cps to 2 mc thus permitting the modulated i-f envelope of the target signal to be visualized without distortion. Since provision is made to synchronize the internally produced X-axis sweep voltage of the oscilloscope with the power-line frequency, the f-m oscillator sweep of the panoramic adapter is easily synchronized with the horizontal time-base sweep of the oscilloscope.

With this equipment, it is possible to select a portion of the 200-ke spectrum displayed on the panoramic scope for more thorough examination. The controls on the

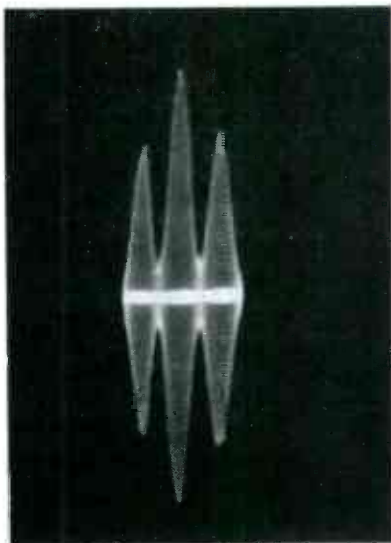

FIG. 6—Standard frequency station WWV

where performance
of product or process
demands

dependable timing

specify

Cramer
time delay relay



Widely used in industrial controls for heat treating, for the control of plastic and injection molding, lapping, induction heating, mixing and agitation, purging gas fired ovens etc. — where accuracy of timing improves quality, reduces supervision or vitally protects the process or equipment itself — the Cramer Type TEC Time Delay Relay provides an adjustable time delay between the operation of a control circuit and the subsequent closing or opening of a load circuit. Designed for dependable, trouble-free service . . . compact construction . . . extremely accurate.

For complete details of the Type TEC — and other dependable Cramer timing instruments — send today for copy of new Cramer Catalog.



THE R. W. CRAMER CO., INC.

BOX 3, CENTERBROOK, CONN.

Builders of dependable timing devices for more than 25 years.

INTERVAL TIMERS • TIME DELAY RELAYS • RESET TIMERS • CYCLE TIMERS
PULSE TIMERS • RUNNING TIME METERS • PERCENTAGE TIMERS

When You Think of
TOROIDAL COMPONENTS...

Think of
**COMMUNICATION
ACCESSORIES CO.**



UNCASED COILS ADJUSTED TO YOUR SPECIFICATIONS

A wide variety in physical size, power capacity and frequency range is offered. Coils are wound to comply with customers' requirements and specifications. Engineering assistance and suggestions are offered without charge.

Coils may be supplied to a tolerance of plus or minus one percent, or matched to a standard inductor to a tolerance of one-tenth percent, or one turn.

Coils may be supplied with temperature coefficient of 180 parts per million per degree Centigrade, or may be supplied with 0° C. coefficient through a limited temperature range.

MOISTURE PROOF PLASTIC COATED TOROIDS

To eliminate the possibility of damage to the exposed winding during assembly, we offer toroids coated with tough thermal setting plastic coating. These coated toroids are recommended where coils are subject to high humidity and where coils must be mechanically mounted. Plastic coating is available in all types of toroidal coils.

STEEL CASED TOROIDS AND FILTERS

C.A.C. engineers, with years of experience in the design of filter networks are at your service to design or help you design the proper networks for your requirements. Where space requirements are severe, filters may be miniaturized by the use of wedding ring toroids and special capacitors. Typical filter cases are shown. However, cases may be fabricated to your specifications.

Write for our
latest catalog



COMMUNICATION ACCESSORIES
Company

HICKMAN MILLS, MISSOURI

GENERAL NETWORK ANALYSIS

Just Published!

Develops both underlying phenomena and techniques of analysis. Covers steady state in lumped networks, steady state in distributed systems, and transients in lumped networks. Gives specialized techniques such as matrices, symmetrical components, transmission-line charts, Fourier series, Fourier integral, and Laplace integral. By **Wilbur LePage** and **Samuel Seely**, both of Syracuse University. 505 pages, 561 illus., 6 x 9, \$8.00.

TELEVISION PRINCIPLES

A practical treatise on the principles and theory of television transmission and reception. Emphasizes basic TV transmitter and receiver design, and such subjects as video amplifiers, cathode followers, grounded-grid amplifiers, signal-to-noise ratios in head-ends, intermediate frequency amplifiers, and detection. By **Robert B. Dome**, General Electric Co. 281 pages, 85 illus., \$5.50.

FRENCH-ENGLISH SCIENCE DICTIONARY

2nd Ed. Just Published!

Conveniently translates over 43,000 scientific and technical terms pertaining to chemistry, physics, mathematics, etc., and related fields, adapting to the increasing overlapping of the sciences. Second edition supplement defines terms in aeronautics, electronics, radar, and television. By **Louis DeVries**, Iowa State College. 2nd Ed. 596 pages, \$6.50.

RADIO ENGINEERING HANDBOOK

Provides quick answers to routine and special assignments in communications, broadcasting, aircraft radio, television, and related fields. Reflecting modern developments in the field, this handbook gives a complete coverage of every aspect of radio engineering—from inductance, power-supply systems, and electron tubes . . . to receiving systems, and code reception—all arranged in concise, quick-reference form. By **Keith Henney**, Editor-in-Chief. 4th Ed. 1197 pages, 1038 illus., \$10.00.

SEE THESE BOOKS 10 DAYS FREE

McGraw-Hill Book Co., 330 W. 42nd St., NYC 36
Send me book(s) checked below for 10 days' examination on approval. In 10 days I will remit for book(s) I keep, plus a few cents for delivery, and return unwanted book(s) postpaid. (We pay for delivery if you remit with this coupon; same return privilege.)

- LePage & Seely—GEN. NETWORK ANAL. \$8.00
 Dome—TELEVISION PRINCIPLES . . . \$5.50
 DeVries—FR. ENG. SCIENCE DICT. . . \$6.50
 Henney—RADIO ENGINEERING HDBK. \$10.00

(Print)

Name

Address

City Zone State

Company

Position I-2

This offer applies to U. S. only



Thomas A Edison

Cuts Costs in Half with SPEED NUTS®

Edison specifies SPEED NUTS after cost comparisons reveal 50% savings over other militarily acceptable fastening methods.

In the very earliest design stages of their aircraft fire detection relay panel, engineers of Thomas A. Edison, Incorporated, checked various methods of attaching connectors to the panel.

Their requirements were rigid. The fastening means had to be light in weight, resist vibration loosening, provide quick and easy assembly, and be in line on cost. Tinnerman Aircraft Connector Mounting Rings proved to be the only fastener

that qualified on all counts. Connectors are quickly inserted through these mounting rings and the panel.

As for cost, Tinnerman SPEED NUTS turned in the finest record by far! Easily 50% assembly savings over acceptable military substitute fasteners were provided by faster, easier, better SPEED NUTS. Complex or simple, solving fastening problems is Tinnerman's specialty. New booklet, "A Story of Quality", reveals how we can help you. Write for your copy. TINNERMAN PRODUCTS, INC., Dept. 12, Box 6688, Cleveland 1, Ohio. In Canada: Dominion Fasteners Ltd., Hamilton. In Great Britain: Simmonds Aeroaccessories, Ltd., Treforest, Wales.

Cut-away view of Edison Fire Detection Relay Panel, left, shows two SPEED NUT Connector Mounting Rings in position. "U" Type SPEED NUTS, self-retained on 4 corners of ring, line up with screws driven from outside panel. Detail drawing, below, is close-up of assembly.

TINNERMAN *Speed Nuts*[®]
Trade Mark Reg. U. S. Pat. Off.
FASTEST THING IN FASTENINGS[®]

the world's toughest transformers

wear these exclusive one-piece drawn-steel cases



CHICAGO

NEW EQUIPMENT TRANSFORMERS

THE ONLY COMPLETE*, VERSATILE LINE WITH TOUGH SEALED-IN-STEEL CONSTRUCTION**

When tougher transformers are made, CHICAGO makes them—in rugged, streamlined drawn-steel cases that provide the fullest enclosure and protection, that look well with other modern electronic components and enhance the appearance of the equipment. The exclusive CHICAGO one-piece drawn-steel case (no seams or spot welds) is the strongest, toughest type of mechanical construction. Further, the one-piece design provides a continuous electrical and magnetic path which means better electrostatic and magnetic shielding. Seamless construction assures maximum protection against adverse atmospheric conditions—means longer, more dependable transformer life.

Whether your transformers must pass the most rigid MIL-T-27 specifications or are intended simply for average, normal applications, it's wise to choose CHICAGO "Sealed-in-Steel" Transformers (the world's toughest) for that extra margin of dependability under all operating conditions.

***COMPLETE.** There's a CHICAGO "Sealed-in-Steel" unit for every application: Power, Bias, Filament, Filter Reactor, Audio, MIL-T-27, Stepdown, Isolation—all in one-piece, drawn-steel cases.

****VERSATILE.** Available in 3 constructions to meet most requirements—a type for every application.

H-Type. Steel base cover is deep-seal soldered into case. Terminals hermetically sealed. Ceramic bushings. Stud-mounted unit. Meets all MIL-T-27 specs.

S-Type. Steel base cover fitted with phenolic terminal board. Convenient numbered solder lug terminals. Flange-mounted unit.

C-Type. With 10" color-coded stripped and tinned leads brought out through fibre board base cover. Flange-mounted unit.



SEND FOR "NEW EQUIPMENT" TRANSFORMER CATALOG

Have the full details at your fingertips on CHICAGO'S New Equipment Line—covering "Sealed-in-Steel" transformers designed for every application and geared to today's circuit requirements. Write for your copy of this important catalog today, or get it from your electronic parts distributor.

CHICAGO TRANSFORMER

DIVISION OF ESSEX WIRE CORPORATION

3501 ADDISON STREET • CHICAGO 18, ILLINOIS



front panel of the panoramic adapter and the oscilloscope may be adjusted to present a portion of spectrum varying in width from 10 to 200 kc. Hence, two or more signals may be studied concurrently which may be particularly desirable in studies of adjacent carrier interference.

The views expressed in this article are the private ones of the author and are not to be construed as official nor as representing the views of the Navy Department or the Naval Service at large.

Gain-Stabilized Mixer

RETENTION OF GAIN CALIBRATION over long periods of time is an outstanding feature of a new type of feedback mixer developed by the National Bureau of Standards. This feature makes the device especially applicable to continuous radio field intensity recorders as well as to other types of frequency-selective measuring equipment.

Gain stabilization is accomplished in the mixer circuit by using the difference frequency voltage from the output of a superheterodyne as negative feedback. When a high degree of feedback is employed, the gain is approximately proportional to the ratio of two constants determined by the switching or modulating function of the mixer tube. One constant is related to the average value of amplifier transconductance and the other refers to the conversion transconductance. Variations in the constants are mainly due to tube aging but are also affected by changes in circuit impedances, oscillator and supply-voltage instability, and so on.

If both constants are changed in a similar manner by approximately the same percentage, there is little

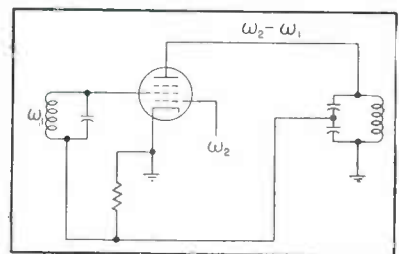

FIG. 1—Schematic diagram of a single-tube feedback mixer using the gain-stabilization principle

Why "dag" Colloidal Graphite is Best for CRT Exterior Walls

"Dag" Exterior Wall Coating has better adhesion . . . requires no baking . . . resists scratching . . . and is economical.

The smooth, uniform, conductive black film obtained with "dag" Exterior Wall Coating adheres tenaciously to all types of glass. Its adherent properties are so good that it resists scratching and readily withstands water immersion.

This specially processed electric-furnace graphite coating is dispersed in a lacquer-base vehicle and is easily applied to CRT surfaces by spraying. It dries so rapidly that tubes can be handled in 2 or 3 minutes after coating. Maximum adherence is obtained by drying at room temperature for 24 hours . . . but the same action will result with infrared drying at 100°C. for ½ hour.

More information on the advantages of "dag" Exterior Wall Coating . . . as well as data on other "dag" dispersions for the electronics and electrical industries . . . is contained in a recent bulletin. Write today for your free copy of Bulletin No. 433-5B.



Acheson Colloids Corporation, Port Huron, Mich.

... also Acheson Colloids Limited, London, England

**For simple,
reliable,
economical
remote
control**

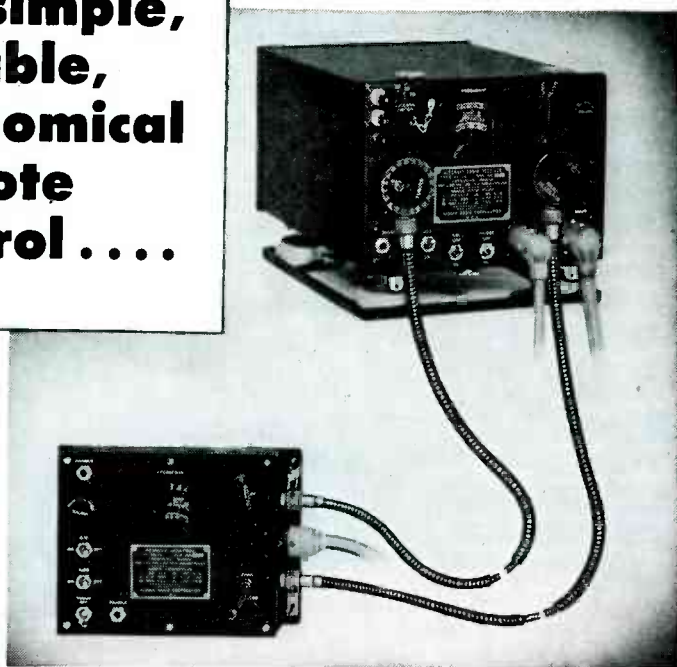

Use **S.S.WHITE** Flexible Shafts

Whether your design calls for transmitting rotary control over long distances—as in the aircraft radio receiver above—or for just a few inches, you'll find S.S.White flexible shafts the ideal way to do it. Here's why—

- S.S.White remote control flexible shafts are specifically engineered for this service. They provide smooth sensitive tuning between any two points regardless of curves, congested conditions or distance.
- They give you full freedom in locating both the controlled parts and their controls wherever desirable to suit space conditions, to facilitate wiring, assembly and servicing and to provide more convenient operation.
- They can be quickly and easily installed and require little or no attention in service.
- Their wide range of sizes and characteristics allow you to satisfy the requirements of practically any remote control application.

**SEND FOR THIS 256-PAGE
FLEXIBLE SHAFT HANDBOOK . . .**

It contains complete authoritative facts on flexible shaft construction, selection and application. Copy sent free if you write for it on your business letterhead and mention your position.



**THE *S.S. White* INDUSTRIAL DIVISION
DENTAL MFG. CO.**



Dept. E, 10 East 40th St.
NEW YORK 16, N. Y.

Western District Office • Times Building, Long Beach, California

- **ELECTRONIC
DESIGN ENGINEERS**
- **TECHNICAL WRITERS**
- **DESIGN DRAFTSMEN**
- **PHYSICISTS**

Westinghouse

offers you

SECURITY AND OPPORTUNITY

EE's and ME's with over 3 years experience . . . a number of excellent positions are now available in our Electronic & X-ray and Air-Arm Divisions for work on:

- Broadcast Transmitters
- Power Line Carrier Communication Equipment
- Railroad Radio
- Radio Frequency Heating
- Medical and Industrial X-ray
- Commercial Radar
- Balancing Equipment
- Military Radar (ship, ground, airborne)
- Military Transmitters
- Specialized Electronic Equipment
- Fire Control Systems
- Automatic Pilots
- Guided Missiles

Check These Outstanding Benefits: Top pay, ideal working conditions, advancement on merit, graduate study opportunities, employee scholarships, paid re-location expenses, Baltimore location.

Send resume of experience and education to: Manager of Industrial Relations, Westinghouse Electric Corp., 2519 Wilkens Ave., Baltimore 3, Md.

**YOU CAN BE SURE...IF IT'S
Westinghouse**



RELAYS BY GUARDIAN



- POWER
- TURRET CONTROL
- GUN FIRING
- COMMUNICATIONS

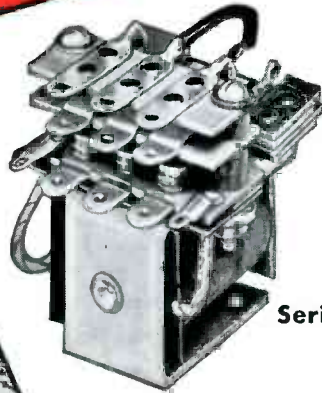

Series 345 D.C.
Relay



- BUSINESS MACHINES
- ALARM SYSTEMS
- AUTOMATIC CONTROLS

FOR TANKS OR BANKS

Fast . . . accurate . . . the power, gun firing, turret control and communications in a fighting tank depend on expert industrial design and production techniques on the homefront, where speed and precision meet again in business machine "paper work". In mills, factories and in banks Guardian Relays control devices that count—compute—sort—convey—package—vend—meter and mail. Basic . . . flexible . . . government approved . . . *hermetically sealed* or open type mounted . . . Guardian Relays serve all fronts . . . will serve you well!



OCTAL PLUG



A. N. CONNECTOR

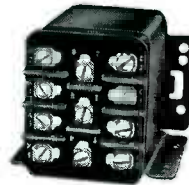

SCREW TERMINAL LUG HEADER



AN-3320-1 D.C.



AN-3324-1 D.C.



Series 595 D.C.



Series 610 A.C.—615 D.C.

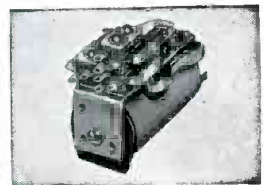

Series 695 D.C.

Get Guardian's New HERMETICALLY SEALED RELAY CATALOG Now!

GUARDIAN ELECTRIC

1625-B W. WALNUT STREET

CHICAGO 12, ILLINOIS

A COMPLETE LINE OF RELAYS SERVING AMERICAN INDUSTRY

DO *You* READ the General Radio Experimenter?

SENT WITHOUT CHARGE each month to scientists, engineers, technicians and others interested in communication-frequency measurements and control instruments, and in electronic laboratory test equipment generally.

Each month the *Experimenter* contains eight pages of engineering articles describing new G-R instruments, new ways of using G-R equipment, or a number of applications of a general engineering nature not specifically related to G-R products.

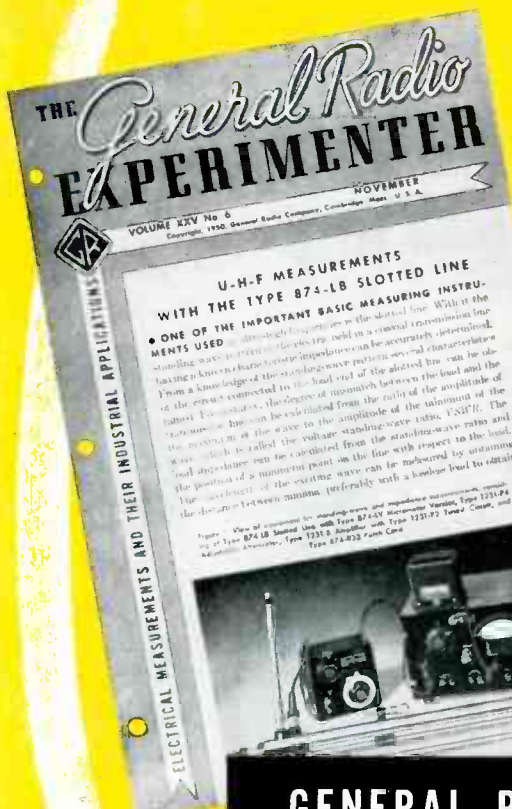

GENERAL RADIO Company

275 Massachusetts Avenue, Cambridge 39, Massachusetts

90 West St., NEW YORK 6 • 920 S. Michigan Ave., CHICAGO 5 • 1000 N. Seward St., LOS ANGELES 38

MAIL THIS COUPON NOW!

If you do not want to cut this magazine, write us, giving all the information requested on the coupon.

effect upon the gain with feedback. Such tubes as the 6SA7 and 6SB7-Y react this way.

In an experimental single-stage circuit, as shown in Fig. 1, a 6SB7-Y was employed as the mixer tube. With 26 db of feedback and a plate supply of 100 v or greater, the gain variation was less than 5 percent of that which would be experienced without feedback. In order to make substantial improvement in the gain stability, a relatively high degree of feedback is required. For this reason, a tube with a high conversion transconductance should be selected. If a relatively narrow bandwidth is desired, the tuned plate circuit should

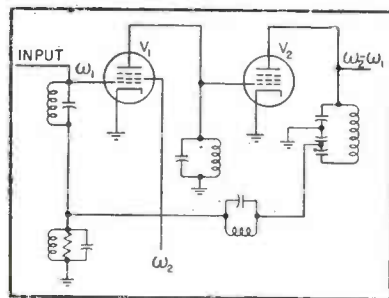

FIG. 2—Circuit using an extension of the gain stabilization principle to a mixer couple

have a high impedance and a high Q.

If feedback is applied over two stages, Fig. 2, using practically obtainable coils of high Q, improved flatness with a relatively narrow bandwidth will result. Feedback voltage is obtained from the capacitive voltage divider of a tuned-plate circuit and is returned to the cathode of the first stage through a parallel resonant circuit. Resulting improvement in gain stability for the mixer couple operating at 3.75 mc with 23 db of feedback is greater than that obtained in the single tube circuit.

Degeneration of both signal and oscillator voltages is appreciable when the mixer tube is operated with a fairly large cathode resistor. In order to avoid this, the phase of the feedback voltage is reversed by suitable means and the feedback applied to the signal grid of the mixer. The circuit is similar to the mixer couple described except that the feedback voltage returns to a junction between a parallel-tuned grid circuit and a grounded shunt

circuit composed of R, C and L. The purpose of the grounded shunt is to furnish the correct terminating impedance for the feedback circuit as well as to provide a sufficiently low impedance at the signal frequency to bypass the grid return. This arrangement has been used to maintain a constant feedback ratio over a frequency range of 1 to 20 mc.

The mixer couple provides improved gain stability, increased gain bandwidth and a gain-frequency characteristic which more nearly approaches an ideally rectangular shape as compared to a cascade, synchronous, single-tuned mixer-amplifier arrangement.

R-F Noise Test for Solderless Connectors

TO DETERMINE whether crimped solderless connectors produce noise in high-gain r-f circuits, a reel containing 7,000 connectors in series was made up by Aircraft-Marine Products Inc. of Harrisburg, Pa. After aging the reel for two years in a warehouse, it was connected as



Connectors on reel for noise test, with battery, r-f choke, variable capacitor and noise meter above. Magnified view below shows the series connectors, spaced apart by an insulating rope



The General Radio *Experimenter* has been published continuously since 1926. Included in recent issues have been such articles as: Description of a Versatile Aperiodic Power Amplifier with a Frequency Range of 20 cycles to 3 Mc; Variac® in Phase-Shift Circuits; A Simple r-f Capacitance Meter; A Technical Discussion of Intermodulation Distortion; A Dynamic Microphone for the G-R Sound-Level Meter; Improved Variac Speed Control; A New Push-Pull Amplifier circuit; A New Octave-Band Analyzer for Noise Measurements; A Sample Holder for Solid Dielectric Materials, and many other Articles of this nature. To receive the *Experimenter*, merely fill in, clip and mail the coupon below.



GENERAL RADIO Company

275 Massachusetts Avenue, Cambridge 39, Massachusetts

90 West St., NEW YORK • 920 S. Michigan Ave., CHICAGO 5 • 1000 N. Seward St., LOS ANGELES 28

Enter my **COMPLIMENTARY** subscription to the *G-R Experimenter*. **504**

Name _____ PLEASE PRINT

Name of Company _____

Company Address _____

STREET CITY & ZONE STATE

Type of Company Business _____

Your Exact Position _____

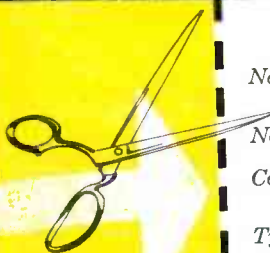

**MANUFACTURERS AND DESIGNERS OF
CONTINUOUSLY VARIABLE
REGULATED DC SUPPLIES**

**MODEL
D6-DUAL,**

HEAVY DUTY



- ✓ DUAL regulated outputs, continuously variable, 0 to 600 volts.
- ✓ Maximum current 200 milliamperes each, or 400 combined.
- ✓ Regulation better than .5%.
- ✓ 6.3 volts AC at 10 amperes center-tapped.
- ✓ Ripple voltage less than 10 millivolts.
- ✓ Stabilized bias supply.
- ✓ Request Bulletin 53 for Detailed Information.

MODELS

A3 AND A3A



- ✓ Continuously variable, 0 to 350 volts.
- ✓ Ripple voltages less than 10 millivolts.
- ✓ Regulation better than .5%.
- ✓ Maximum current 200 milliamperes.
- ✓ Stabilized variable bias supply.
- ✓ 6.3 volts AC at 5 amperes.
- ✓ Request Bulletin 52 for Detailed Information.

Oregon ELECTRONICS

2232 E. BURNSIDE STREET, PORTLAND 15, OREGON, U.S.A.

MFG. CO.

**ONLY
SPECIFIC COILS
CAN DO
THIS JOB-**



The components of high altitude airborne radar installations must be extremely accurate because a given voltage jumps a longer distance in the stratosphere where the atmospheric pressure is lower. The focus coil, shown below, goes around the neck of the Cathode Ray Tube and focuses the beam. The nature of its use demands that it meet the most exacting electrical and physical specifications.



Builds Them!

When you need electrical coils, why not take advantage of 34 years of experience, engineering competence, and modern production facilities. Coto coils are built for you, to your specifications.

COTO-COIL CO., INC.
COIL SPECIALISTS SINCE 1917
65 PAVILION AVE
PROVIDENCE 5, R.I.



D-H RADIO ALLOYS

Provide Important Parts for

DUMONT'S

Selfocus Teletron

Latest development in picture tubes is the Du Mont Selfocus Teletron which provides *automatic focus at all times without the aid of external circuits or devices*. This eliminates the focusing coil or PM unit now used on standard electromagnetic-focus picture tubes, affording a substantial saving of vital materials in the manufacture of television receivers.

The Selfocus Teletron employs electrostatic focus with magnetic deflection, and this type of receiver is unique among electrostatic-focus tubes because its focusing element is operated at zero volts and is tied internally to the cathode through a resistor.

The elimination of focus circuits from the receiver is made possible largely by the focusing cylinder of the Selfocus picture tube. The unusual design of the cylinder and the precision with which it can be located in the electron gun produce increased picture quality by minimizing defects which have been inherent in conventional picture tubes. With greater control of these defects, it is possible to maintain quality uniformly from tube to tube.

Driver-Harris, who has been supplying Du Mont with alloys for cathode ray tubes for more than 10 years, supplies Stainless Steel 18-12 and special D-H Nickel No. 599 for manufacture into important parts of the electron gun of Du Mont's new Selfocus Teletron. The special requirements of this facet of the television industry are well served by the properties of these metals.

At present, strategic materials and the alloys made from them are inevitably on strict allocation. However, we shall be glad to make recommendations based upon your specific needs, and serve you to the best of our ability.

*Makers of the most complete line of
electric heating, resistance and electronic alloys
in the world*

Driver-Harris Company

HARRISON, NEW JERSEY

BRANCHES: Chicago, Detroit, Cleveland, Los Angeles, San Francisco

In Canada: The B. GREENING WIRE COMPANY, LTD., Hamilton, Ontario, Canada

*T.M. Reg. U.S. Pat. Off.



**"I'm tough and rugged..
but the SWEETEST mike you ever owned!"**



TOUGH?

Yes, the Turner Model 99 Dynamic is the greatest mike in the world for taking hard knocks...yet retains the perfect response and sensitivity that make the 99 an outstanding microphone value.

Indoors or outdoors — for ham rig, broadcast remotes, sound installations — the Turner 99 is completely dependable. For mobile public address systems, paging systems, communications or recording machines, the 99 delivers crisp, clear results. Its smooth response is not affected by heat, cold or humidity.

Specify the Turner Model 99 Dynamic microphone with confidence. Use it with pride. Order from your Turner dealer or representative, or write direct for complete microphone literature.



**TURNER
Model 99**

Response: 60 — 9000 c.p.s.
Level: 52 db below 1 volt/dyne/
sq. cm. at high impedance
Impedance: 50, 200, 500 ohms
or high impedance
List Price -----\$36.00

THE TURNER COMPANY

IN CANADA:

Canadian Marconi Co., Ltd.
Toronto, Ont., & Branches

EXPORT:

Ad. Auriema, 89 Broad Street
New York 4, N. Y.



905 17th Street N.E.
Cedar Rapids, Iowa

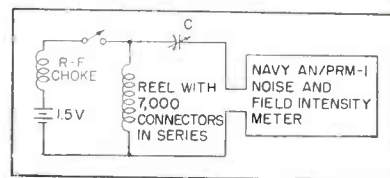

Test setup for solderless connectors. The r-f choke blocks noise originating in the battery

shown to a noise meter, using a variable capacitor to tune out the inductance. Results indicated that any noise that exists either with or without direct current flowing in the connectors is less than an order of magnitude above the inherent thermal noise of the circuit.

Fast Construction of Temporary Circuits

By ARTHUR R. JUBENVILLE

*Electrical Instructor
R. L. Simpson High School
Huntington, New York*

A RECENT development in the bread-board technique has been engineered which completely eliminates the aggravating time-consuming factors as well as the unreliability and awkwardness of existing methods for temporary circuit construction.

This latest approach to temporary circuitry is unusually practical because of its design. Components are mounted on individual bases in which two retaining pins $\frac{1}{8}$ in. in diameter are fitted. Holes for these pins are drilled throughout the base panel on 1-in. centers. This situation makes it possible to mount speedily any series of components in the desired physical and electrical relationship.

Elements of all components

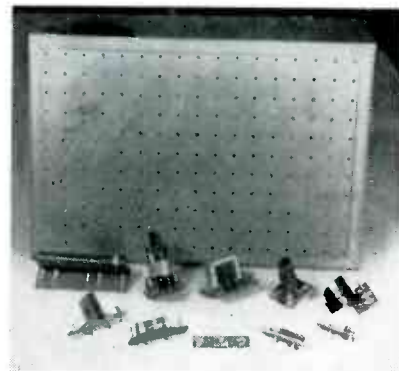

Components ruggedly mounted on individual bases may be securely positioned on panel as first step in circuit construction

GREATER **AEROCOM** PRODUCTION! SAME **HIGH** QUALITY!

Illustrated here are a few of AeroCom's high-quality products, designed and engineered for the communications industry. Other equipment manufactured: a very-high-frequency (AM) transmitter (VH 200), a dual automatic package-type radio beacon, 50, 100, and 1000-watt M. F. transmitters, an airborne H. F. transmitter, meteorological instruments, and a 50-watt H. F. (AM) transmitter — all top-quality products.

A letter is all that is needed to get technical information on any of AeroCom's equipment. All the equipment manufactured by AeroCom is ruggedly constructed and conservatively rated, assuring you long, trouble-free service.



446
Four-channel,
H. F. transmitter

12GLX-M
1 kw Beacon
transmitter

AK-3
Identification keyer

BEACON
Package 50 or 100 watt
transmitter

LMI-72
Line match
indicator

ACA
Auto transfer

DA-200
Artificial antenna

AR-72
H. F. Airborne
receiver

CONSULTANTS, DESIGNERS AND MANUFACTURERS OF STANDARD OR SPECIAL
 METEOROLOGICAL AND COMMUNICATIONS EQUIPMENT



AERONAUTICAL COMMUNICATIONS EQUIPMENT, INC.
 3090 Douglas Road, Miami 33, Florida

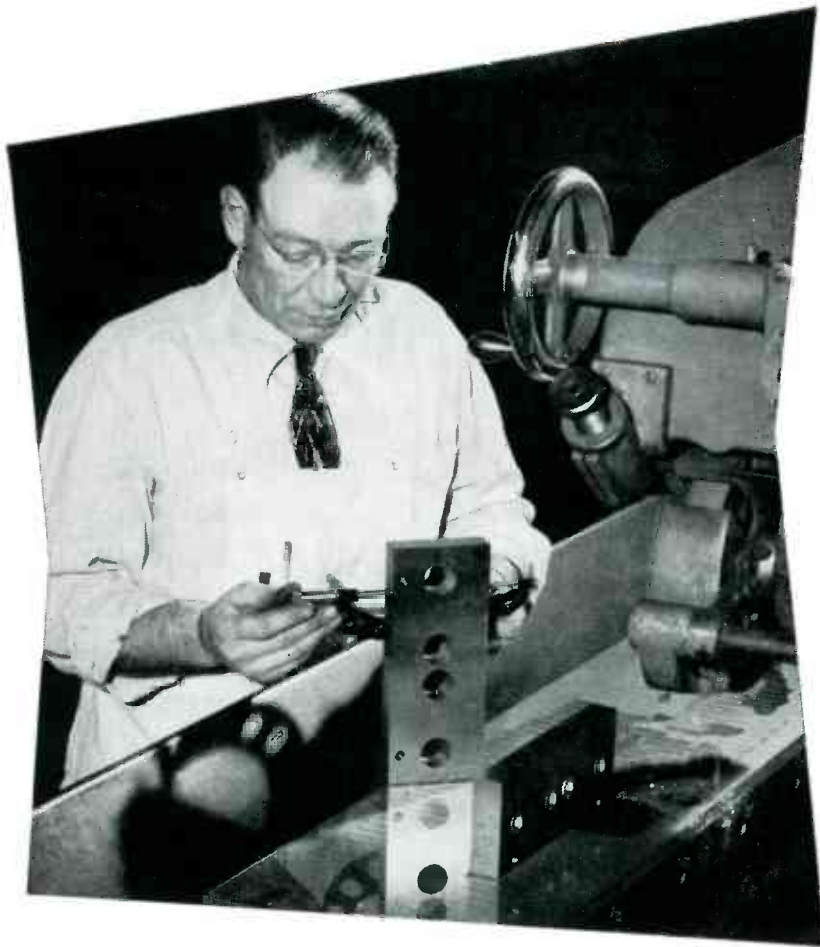

Here's Where Quality Begins in Corry-Jamestown Housings

Quality begins in the tool room at Corry-Jamestown, where our skilled tool makers have the complete facilities to make the precise machine tools we need to produce your housings, cabinets or completed assemblies. And that same high degree of quality carries through every step of our production.

We have a large force of skilled metal fabricators who have up to thirty years experience operating our wide variety of shears, presses and brakes . . . automatic welding equipment . . . and modern finishing equipment. That's why you can count on Corry-Jamestown for the precision construction that will *always* meet your exact specifications. ● Just give us the word and we'll immediately put our engineers to work on your production problem, and let you know *exactly* how we can serve you.

CALL, WRITE OR WIRE US TODAY!

CORRY-JAMESTOWN MFG. CORP.

CORRY, PENNSYLVANIA

Makers of famous Steel Age office furniture

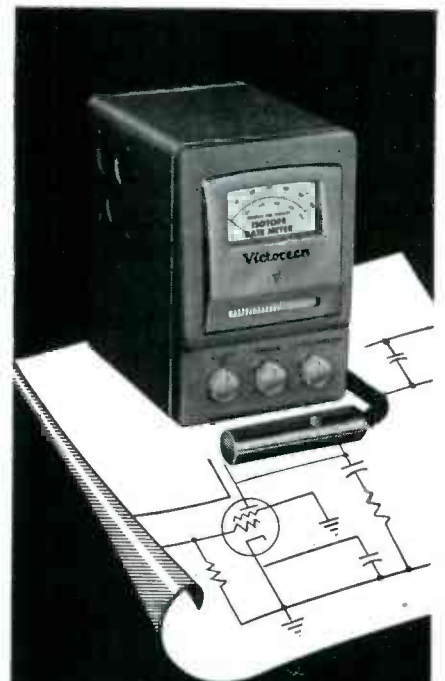

a product of . . .
Technical Know-how
Sound Engineering
Quality Workmanship

THE ISOTOPE RATEMETER

A New Laboratory Counting Ratemeter

The Model 524—Isotope Ratemeter is a laboratory-quality, counter-type ratemeter for detecting and monitoring alpha, beta, and gamma radiation. It has been designed for the exacting requirements of medical or laboratory personnel for use in chemical or isotope research laboratories. This instrument is applicable to civilian defense and numerous industrial requirements.

A wide selection of counting rates is provided: 0-300, 0-1000, 0-3000, 0-10,000, 0-30,000, and 0-100,000 counts per minute. Aural as well as visual presentation is featured. A three-position meter time-constant switch allows the operator to select the most desirable speed of response. The probe assembly uses standard co-axial base counter tubes and is connected to the case by means of a four-foot flexible cable. The instrument operates from a 115 volt AC supply. The rugged 10 x 7 x 8" case is finished in gray baked enamel.



For more complete information on the Isotope Ratemeter, write for Bulletin (Form 3002-B).

Victoreen
Instrument Co.

5806 HOUGH AVE.
 CLEVELAND 3, OHIO

Only One Source gives you Double Duty TV!

Highest Quality Studio
Programming Resources — plus



Portable Packaging for Maximum
Studio-Field Flexibility!

When you invest in GPL TV *studio* equipment, you're buying *field* equipment as well. Every GPL unit provides unparalleled flexibility, light weight, easy handling, precise control. Let GPL engineer *your* station, from camera to antenna. Have *The Industry's Leading Line* — in quality, in design.

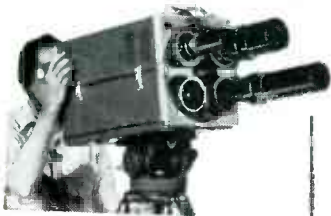

Camera Unit

Precision-built, lightweight, fast-handling. Push-button turret, remote iris control, remote focus and range selection. Easiest to service.



Camera Control Unit

Touch-identified controls. 8½" monitor tube. Split or single headphone intercom system. CRO views horizontal, vertical, and vertical sync block. Iris control.



Camera Power Unit

Rugged, dependable, compact. Matched to other units in GPL chain. Standard relay panels swing out for maintenance.



Synchronizing Generator

Affords maximum circuit reliability without operator adjustment. Binary counters and delay lines, stable master oscillator. Built-in power supply.

Complete TV Station Installations from Camera to Antenna



Video Switcher

Full studio flexibility anywhere. Control can view, preview, fade, dissolve, etc. Views any of 5 inputs, 2 remotes, outgoing line. Twin fade levers.



3-2 Projector

Portable sync unit. No need for special phasing facilities. Projects rear-screen or "direct in." Ideal for remote origination of film. Relieves load on Telecine.

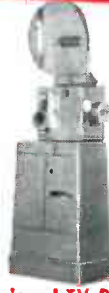

Professional TV Projector

Highest quality 16-mm projector designed specifically for TV. Delivers 100 foot-candles to tube. Sharp, steady pictures from 4000-foot film magazine.



Remote Control Box

Provides revolutionary remote control of camera focus, lens change, pan, tilt. Styled to match other components in the GPL TV line.

See Remote Control in Action—Booth 18-20 IRE Show.

WRITE
WIRE
OR PHONE
FOR DETAILS



General Precision Laboratory

INCORPORATED

PLEASANTVILLE

NEW YORK

TV Camera Chains • TV Film Chains • TV Field and Studio Equipment • Theatre TV Equipment

BALLANTINE STILL THE FINEST IN ELECTRONIC VOLTMETERS



Ballantine Model 300
SENSITIVE
ELECTRONIC
VOLTMETER
Featuring a Logarithmic
Voltage Scale and
Uniform Decibel Scale

PRICE . . . \$210.

- Measures 1 millivolt to 100 volts over a frequency range from 10 to 150,000 cycles on a single logarithmic scale by means of a five decade range selector switch.
- Accuracy: 2% at any point on the scale up to 100 KC and better than 3% above 100 KC.
- Input Impedance: $\frac{1}{2}$ megohm shunted by 30 mmfds.
- Generous use of negative feedback assures customary Ballantine stability.
- Output jack and output control permit voltmeter to be used as a flat high gain (70DB) amplifier.
- Available accessories permit range to be extended up to 10,000 volts and down to 20 microvolts.
- Available Precision Shunt Resistors convert voltmeter to microammeter covering range from 1 to 1000 microamperes.

For additional information on this Voltmeter and Ballantine Battery Operated Voltmeters, Wide-Band Voltmeters, Peak to Peak Voltmeters, Decade Amplifiers, Multipliers and Precision Shunt Resistors, write for catalog.

BALLANTINE LABORATORIES, INC.

100 FANNY ROAD, BOONTON, NEW JERSEY



mounted on the bases terminate in $\frac{1}{8}$ -in. posts, which provide excellent contact with the Jiffy Clip connector used in completing the circuit. Accessibility of all terminals plus the ease and speed with which any junction may be opened or closed, permits rapid, efficient component substitution and evaluation and greatly facilitates electrical-measurement and trouble-shooting procedures.

The fact that no tools are required, with no soldering or wire preparation necessary, presents a unique situation. The operator may concentrate completely on circuit interpretation, construction and testing without being distracted and retarded by difficult and im-

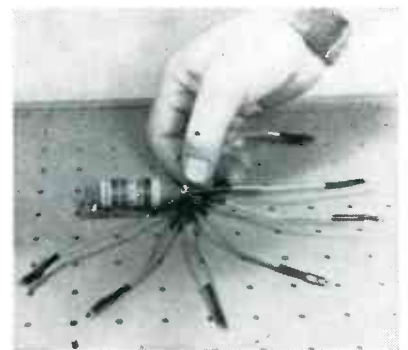

Connector is attached to post by pressing on at right angles to post or by fitting to top of post and sliding to desired position

practical mechanical connections or confusing lash-ups.

Up to seven conductors may be connected to a given terminal as easily as one may be connected. The nature of the connector is such that accidental shorts or disconnection of jumpers is not likely, yet complicated circuits may be "undressed" completely and easily in a matter of seconds.

As a result of the excellent conductivity of the connector, all circuits function as normally as if soldered. Tests have proved that the conductivity of the connector compares favorably with any present method of joining wires to elements, including soldering.

The design of the Jiffy Clip makes possible the above mentioned features. The clip is fundamentally a U-shaped device, fabricated from 0.051-in. round phosphor-bronze spring wire. It has been life tested

**YOU ARE LOOKING AT
THE MOST Accurate and MOST Rugged
TIME-MEASURING INSTRUMENT IN GENERAL USE
IN THE WORLD!**

The
STANDARD

PRECISION TIMER

It's There — in the "Clutch"
the Heart of STANDARD'S
Uncanny Precision
Performance

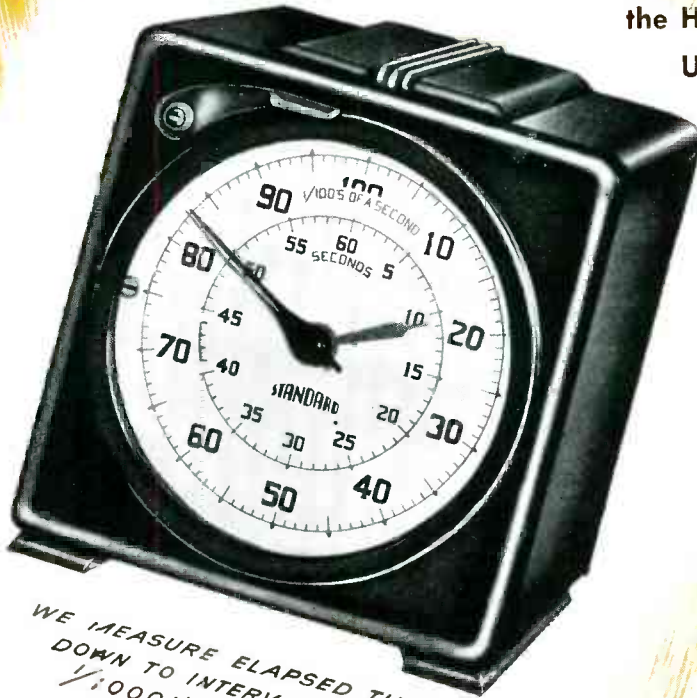

WE MEASURE ELAPSED TIME
DOWN TO INTERVALS OF
 $\frac{1}{10000}$ th SECOND

Available
in 12 Models
Manually and
Electrically
Operated
•
Portable Cases
or
Panel Mounting
•
Optional
Changes to
Conform to
Customers'
Requirements

WRITE
for



Government
Educational
Institutions
Electrical
Industries
Scientific
Laboratories
Aviation
Automotive
Chemical
Food
Textile
Paper
Petroleum
Hundreds of Other
INDUSTRIAL
Classifications

Let our Engineers
help you with
Your Special
Timing Problems

THE STANDARD ELECTRIC TIME COMPANY

97 Logan Street, Springfield 2, Massachusetts

TIMERS AND CHRONO-TACHOMETERS

LABORATORY PANELS

PROGRAM CLOCK SYSTEMS

PIPELINE ANALYZERS

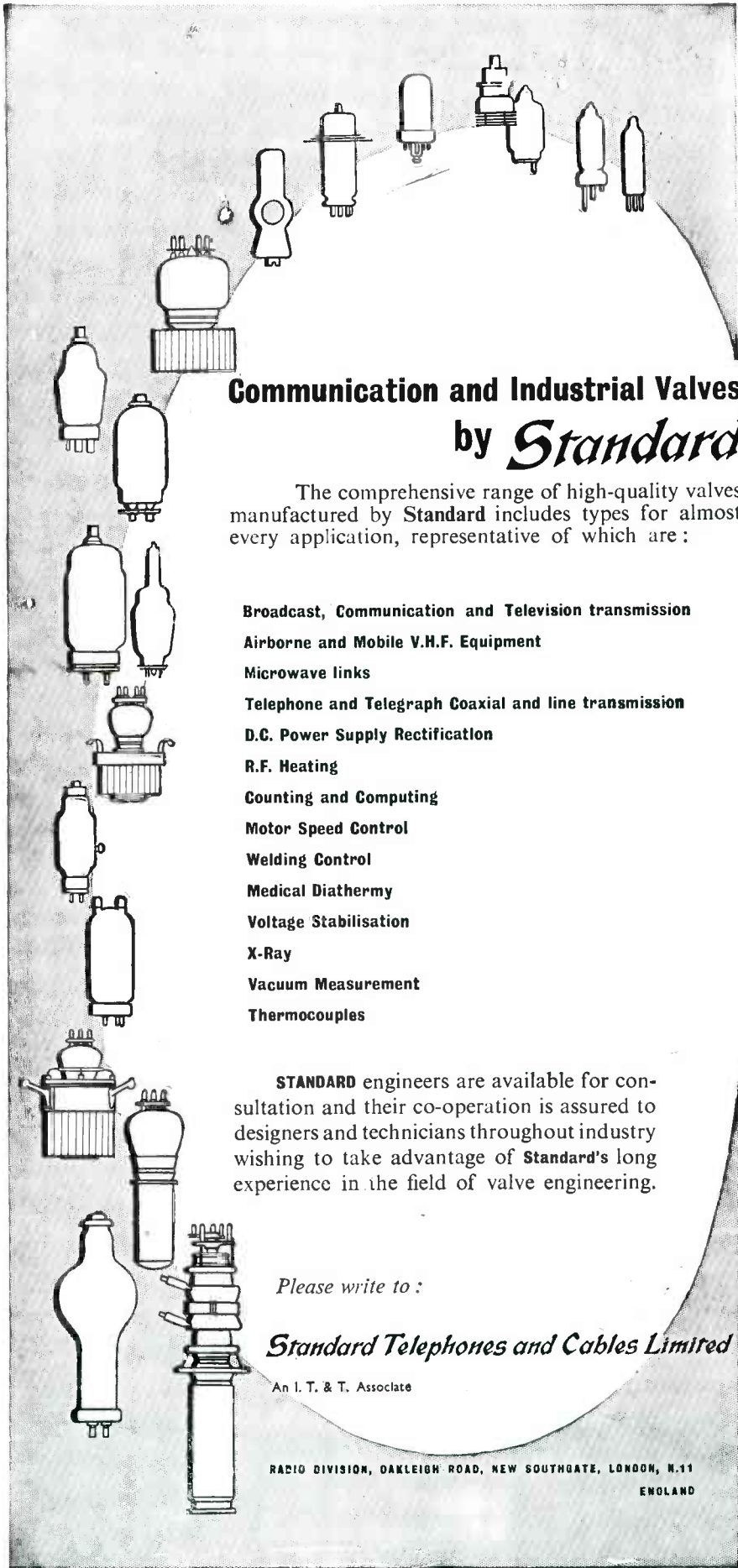

Communication and Industrial Valves by *Standard*

The comprehensive range of high-quality valves manufactured by **Standard** includes types for almost every application, representative of which are:

- Broadcast, Communication and Television transmission
- Airborne and Mobile V.H.F. Equipment
- Microwave links
- Telephone and Telegraph Coaxial and line transmission
- D.C. Power Supply Rectification
- R.F. Heating
- Counting and Computing
- Motor Speed Control
- Welding Control
- Medical Diathermy
- Voltage Stabilisation
- X-Ray
- Vacuum Measurement
- Thermocouples

STANDARD engineers are available for consultation and their co-operation is assured to designers and technicians throughout industry wishing to take advantage of **Standard's** long experience in the field of valve engineering.

Please write to:

Standard Telephones and Cables Limited

An I. T. & T. Associate

RADIO DIVISION, OAKLEIGH ROAD, NEW SOUTHGATE, LONDON, N.11
ENGLAND

Prime and Sub-Contractors

**Look First to
PHOENIX**

Phoenix is geared to meet the most stringent specifications for electronic apparatus in both government and civilian fields. Phoenix is first in production efficiency of



We are equipped to work with you on your special problems. Write today for complete details.

PHOENIX ELECTRONICS
INC.
LAWRENCE, MASS.

DONGAN Transformers ARE INSULATED WITH NATVAR Varnished Cambric

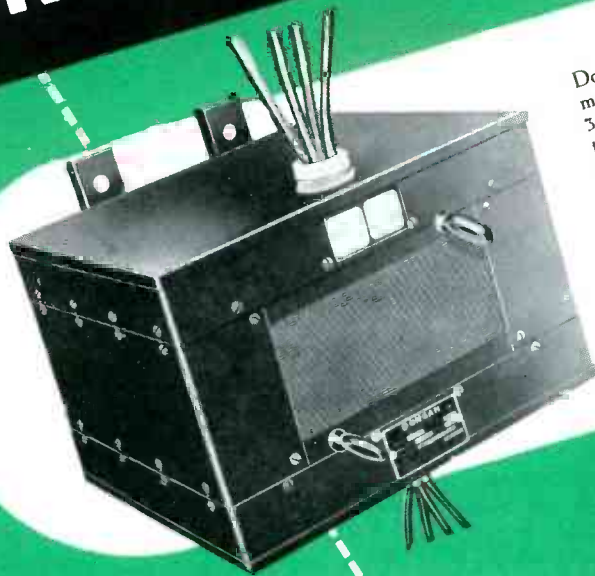

Dongan power circuit transformers are made in capacities from .050 KVA to 57.5 KVA, single phase and from 3 KVA to 50 KVA, three phase. Single phase transformers have two primaries and two secondaries which can be connected either in series or in parallel. Dongan #55-1000, illustrated, is rated 10 KVA; primary, 460/230 volts; secondary, 230/115 volts; 50/60 cycles. Natvar varnished cambric is used as insulation between the four windings and also as an outside wrap for the entire coil assembly.



Natvar Products

- Varnished cambric—straight cut and bias
- Varnished cable tape
- Varnished canvas
- Varnished duck
- Varnished silk
- Varnished special rayon
- Varnished Fiberglas cloth
- Silicone coated Fiberglas
- Varnished papers
- Slot insulation
- Varnished tubing and sleeving
- Varnished identification markers
- Lacquered tubing and sleeving
- Extruded plastic tubing and tape
- Extruded plastic identification markers

Ask for Catalog No. 22

Dongan Electric Manufacturing Co., Detroit, has manufactured "The Dongan Line Since 1909." This line of dry-type transformers includes air cooled power circuit transformers, transformers for gas and oil burner ignition, for neon sign and cold cathode lighting, for electronics and communications equipment, and for machine tools.

Natvar Varnished Cambric has been used as insulation for many years because of its consistently good electrical and mechanical properties.

All Natvar flexible insulations are consistently uniform no matter when or where purchased. They are available either from your own wholesaler's stock or directly from us.

THE NATIONAL VARNISHED PRODUCTS Corporation

Telephone
Rahway 7-8800

Cable Address
NATVAR: Rahway, N. J.

201 RANDOLPH AVENUE ★ WOODBRIDGE, NEW JERSEY

**When in need of electrical
INSULATING MATERIALS...
Remember the BRAND name**

*Place your
Confidence in*

TURBO

**CAMBRIC CLOTHS,
TAPES and PAPERS**

Whatever your need — be it varnished insulation for electrically operated apparatus or equipment, transformers or electric power cables — there is a Turbo quality product to provide the required safeguard. The Turbo line includes: straight-cut and seamless-bias varnishes cambric and tape; splicing tapes, glass and glass coated materials; glass and cambric slot insulation; varnished kraft, coated asbestos, varnished and special processed papers; silicone coated asbestos and treated asbestos cloth; and special products to meet specific applications other than standard.

For complete satisfaction in mechanical and electrical properties with outstanding flexibility, specify and buy the Turbo brand of insulating materials. Write today for catalog information listing physical and electrical properties, colors, packaging and other technical data.



TURBO

THE WILLIAM BRAND AND CO., INC.

INSULATING MATERIAL SPECIALISTS SINCE 1920
106 VALLEY STREET, WILLIMANTIC, CONNECTICUT, U.S.A.



TURBO Insulated Wire and Wire Markers
Extruded Tubing • Glass Tubing • Varnished Tubing
Glass Sleaving • Saturated Sleaving
Cambric Cloths • Tapes • Papers • Mica

SALES REPRESENTATIVES IN PRINCIPAL CITIES

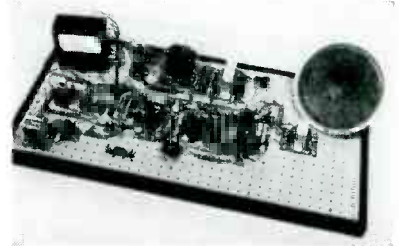

Circuit of a three-stage 15-watt phase-inversion amplifier. Construction time. 30 to 35 minutes; disassembly time. 3 to 5 minutes

to 7,000 applications to and from the post and remained effective. A notch with a radius of $\frac{1}{8}$ in., with a minimum of 2,500 circular mills area of contact is swaged into the inner side of each of the extending arms. This notch is held to a very close tolerance, resulting in a mating fit with the post that insures a maximum resistance not greater than one thousandth of an ohm. The contact area is such that up to 30 amperes may be effectively carried.

The inner portion of the ends of the arms are swage beveled to facilitate application to the post by pressure at right angles to post. The connector may also be simply fitted to the top of the post and pressed down to the desired position. Any single connector may be easily removed from a group without disturbing remaining connectors. The plastic sleeve is for insulation purposes only, the grip at the junction being maintained by the action of the phosphor-bronze spring wire.

**Line-Terminated Pulse
Stretcher**

By L. REIFFEL and G. M. BURGWARD

*Armour Research Foundation
Illinois Institute of Technology
Chicago, Illinois*

THE IDEAL pulse stretcher produces a rectangular pulse rather than the exponential decaying type. One possible technique recently described¹ utilizes the shunt charging of a lumped parameter line. This technique requires a charging diode for each section of the line and a very-low impedance charging circuit making the stretching of high-amplitude signals difficult with stretching by a factor of 25 being a practical upper limit.

It is possible to terminate

LITTON INDUSTRIES NEWS

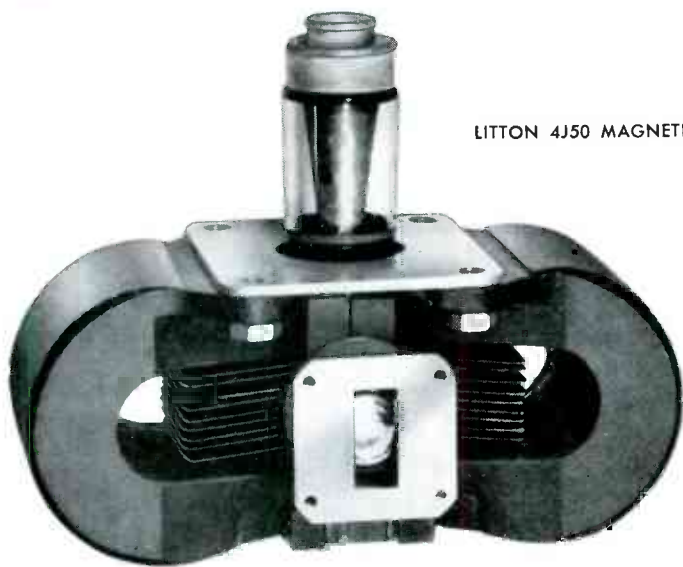

LITTON 4J50 MAGNETRON

SNAP-ON OPERATION, LONG SHELF LIFE WITH LITTON X BAND MAGNETRONS

Two high-quality pulse magnetrons in the 9345 to 9405 mc/sec range are now being manufactured by Litton Industries. Designated 4J50 and 4J52, these magnetrons require no aging or seasoning. Special design and processing have resulted in tubes with long shelf life and snap-on operation to full power immediately after completion of the cathode warm-up period.

These tubes offer either high or medium power outputs. Litton 4J50 is a high-power magnetron providing 225 kw minimum peak at .001 duty. 4J52 is a medium power magnetron offering 65 kw minimum peak at .001 duty. Both operate at or beyond ratings.

MOLECULAR LUBRICANT PRODUCTS

Litton Molecular Lubricant "C" has a vapor pressure of approximately 10^{-7} mm. Hg. at room temperature. In the presence of ionization it will

give an indicated pressure of 10^{-6} mm. Hg. Its principal use is in vapor pumps and as a lubricant for bearing operation in vacuum.

Great care has been exercised in its refinement, and the product has a very narrow boiling range. The color and fluorescence are inherent to the material.

This oil has excellent lubricating qualities at temperatures below 100° C. and is suitable for use with anti-friction bearings operating within dynamic vacuum systems.

OIL VAPOR VACUUM PUMPS

The Litton Oil Vapor Vacuum Pumps are of all-steel construction which obviates the possibility of glass breakage and substantially increases the length of service of the equipment.

Boiler and charcoal baffles are easily demountable for cleaning purposes. Litton pumps feature replaceable external heaters, special cooling coils and demountable baffles. These pumps can be obtained in various combinations with high vacuum valve, with charcoal baffle for straight-through operation or side opening.

The Litton pump with charcoal baffle (straight-through operation) has an ultimate vacuum of 5×10^{-8} mm. of mercury. The speed (measured at 10^{-5} mm. of mercury) is 75 to 100 liters.

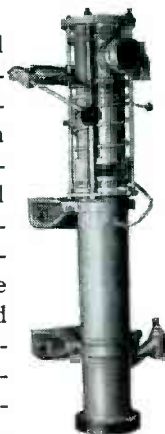

NEW LITTON PLANT ADDITION

Litton Industries has added a new building to its plant at San Carlos, California. 40,000 square feet of space is now used for research, manufacturing and general offices. The new building is windowless concrete-and-glass-block construction, completely air conditioned. The interior is light engineered for optimum working conditions.



Write for price and delivery information. Data subject to change without notice.

LITTON INDUSTRIES

SAN CARLOS, CALIFORNIA, U. S. A.

2370

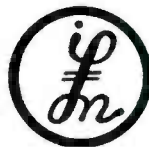

DESIGNERS AND MANUFACTURERS of:

Glassworking Lathes and Accessories, Vertical Sealing Machines, Burner Equipment, Precision Spotwelders, Oil Vapor Vacuum Pumps, Glass Baking Ovens, Vacuum Tubes and Tube Components, Magnetrons, High Vacuum Molube Oil, Microwave Equipment.

**A responsible
low-cost source
of supply for
quantity users
of *precision***

shaped wire

we produce these and any other special shapes, in all ferrous and non-ferrous metals and alloys, to customers' specifications up to 3/4" wide and 3/16" thick. Tolerances: ± .0005

stampings & piercings

any shape, any type to customers' specifications, in all ferrous and non-ferrous metals and alloys, within these dimensional limits: Over-all size—up to 1". Thickness of stock—up to 1/16". Tolerances: ± .0005

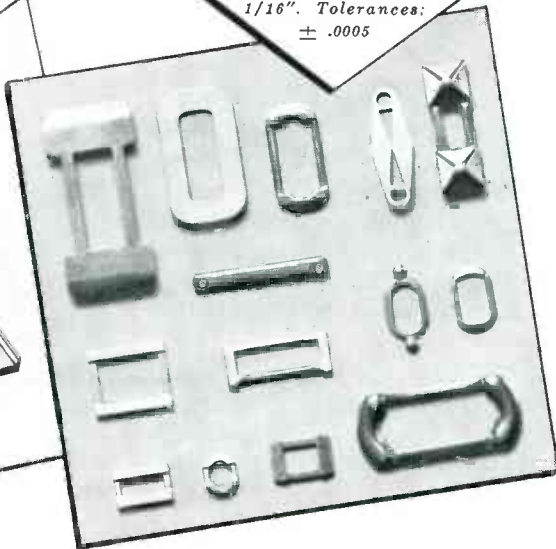
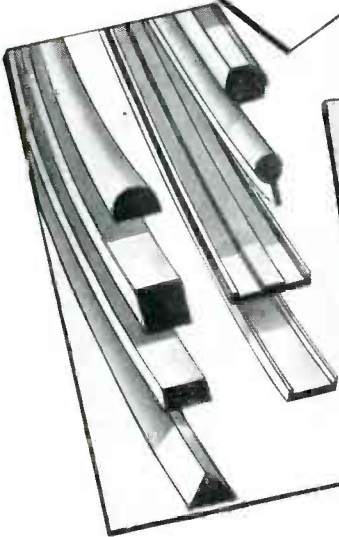

As one of the country's foremost manufacturers of fine quality jewelry chain, our plant is equipped with hundreds of high-speed wire drawing and forming machines. Many of these machines, which were designed and built by this organization from the ground up, are also capable of producing the most

intricate stampings and piercings to customers' specifications.

• • • Additional facilities such as an up-to-date tool shop plus complete finishing equipment — including tumbling, polishing, heat treating — assure you of on-time deliveries to meet your defense work schedules.

SEND BLUEPRINT OR SAMPLE & QUANTITY REQUIREMENT FOR COST COMPARISON & DELIVERY, OR CALL SOUTH ORANGE 2-7600.

universal chain co. inc.
92 burnett avenue, maplewood, n.j.



**WIND more
COILS faster**

**WITH YOUR
PRESENT
COIL-WINDING
MACHINE!**

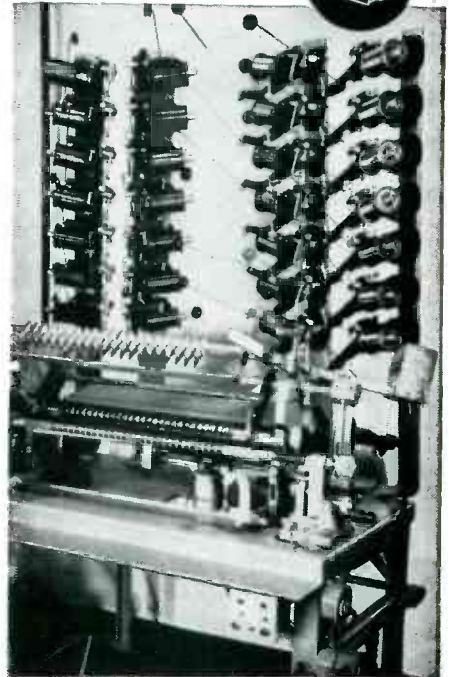

— use
PAMARCO
Wire DeReeling Tensions
for PERFECT COILS

Installation of these inexpensive PAMARCO tensions lowers winding costs because each machine will accommodate more coils at higher winding speeds. In addition to increased production, PAMARCO tensions raise production quality. Free-running action practically eliminates wire breakage and shorted turns. Simple thumb screw setting quickly adjusts for any wire gauge. No tools or special skill are needed for operation. For complete data call or write.



**PAPER MACHINERY
& RESEARCH, INC.**

1014 OAK STREET
ROSELLE, NEW JERSEY

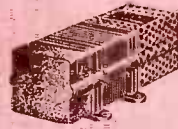
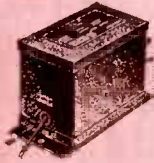

SOLA voltage regulation

for Military Components

TYPICAL EXAMPLES

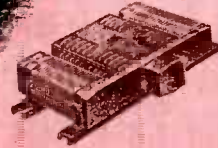

OF THE MANY REGULATING

Unfailing voltage control is vital to the performance of today's complex, sensitive electrical and electronic military devices. The manufacturer of such a device can insure its continuous optimum performance by "building in" a SOLA Constant Voltage Transformer to insure the proper input voltage required.

SOLA regulators are ideal for military use. They are rugged . . . completely automatic . . . instantaneous in response . . . have no moving or expandable parts . . . require no manual adjustment or maintenance . . . and are self-protecting against short circuit. The standard units will regulate secondary voltage output within $\pm 1\%$ regardless of continuous line voltage fluctuations as great as 30%.

In addition to line voltage regulation for 115 and 230 volt service, SOLA regulators are available in many special types such as: harmonic-neutralized units for commercial sine wave output; regulated plate and filament power supply transformers; adjustable, regulated A.C. voltage supplies; low voltage, high current filament transformers for oscillators and other large tubes.

The engineering skill and production facilities of the SOLA ELECTRIC CO., the world's largest manufacturer of constant voltage transformers, are available for defense production. SOLA regulators were purchased during World War II directly by the Signal Corps, Air Force and Navy as well as primary military contractors.

We invite your inquiries about standard and custom designed regulators, or the use of SOLA engineering and production facilities as a sub-contractor. Your request will be promptly answered.

TRANSFORMER TYPES

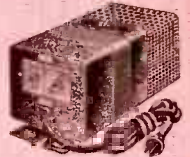
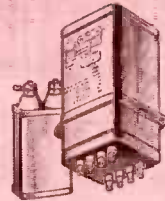

PRODUCED BY THE

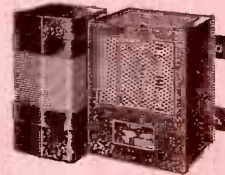

SOLA ELECTRIC CO.

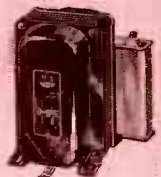

SOLA *Constant Voltage* TRANSFORMERS

Transformers for: Constant Voltage • Fluorescent Lighting • Cold Cathode Lighting • Airport Lighting • Series Lighting • Luminous Tube Signs • Oil Burner Ignition • X-Ray • Power • Controls • Signal Systems • etc. • SOLA ELECTRIC CO., 4433 W. 16th Street, Chicago 50, Illinois

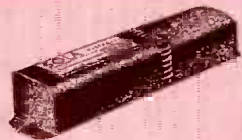

NEW - Fast - Reliable - Lower Cost!



- * DIRECT READING
- * COUNTING TO 1,000,000 CPS
- * RUGGED PLUG-IN CONSTRUCTION

Berkeley's complete line of decimal counting units includes the improved Models 700A and 705A, now offering higher counting speeds, increased stability and longer operating life. Two new units, the 706A and 707A, have been added to provide maximum counting rates of 350,000 and 1,000,000 cps respectively. All units are designed for cascade arrangement to provide any desired total count capacity. All units of same model number interchangeable without adjustment. Instantaneous reset to zero through opening of grid return circuit.

SPECIFICATIONS

	MODEL 700A	MODEL 705A	MODEL 706A	MODEL 707A
Maximum Counting Rate	40,000 cps	100,000 cps	350,000 cps	1,000,000 cps
Resolution—Pulse Pairs	5 μ sec.	5 μ sec.	1 μ sec.	0.8 μ sec.
Tubes	4-5963	4-5963	4-5963 5-6AL5	4-5687 6-6AL5
Plug-In Mounting	Octal	Octal	11 pin	11 pin
Dimensions	1 $\frac{3}{8}$ "x5 $\frac{1}{2}$ "x5 $\frac{1}{2}$ "	1 $\frac{3}{8}$ "x5 $\frac{1}{2}$ "x5 $\frac{1}{2}$ "	2 $\frac{1}{2}$ "x5 $\frac{1}{2}$ "x5 $\frac{1}{2}$ "	3 $\frac{1}{4}$ "x5 $\frac{1}{2}$ "x5 $\frac{1}{2}$ "
Weight	12 oz.	12 oz.	24 oz.	24 oz.
Price*	\$50	\$60	\$95	\$145

* **LOWER COST — A Berkeley Policy**

Continually-widening applications for Berkeley instruments and components have enabled us to realize substantial economies in manufacturing cost. These benefits are distributed equably among those who have made them possible—our customers, our engineering and manufacturing group, and our field organization. To you, the user of Berkeley instruments, these benefits accrue in the form of better and better equipment at lower and lower cost.

FOR COMPLETE INFORMATION, please write for bulletin 700-E

Berkeley Scientific Corporation

2200 WRIGHT AVENUE • RICHMOND, CALIFORNIA

abruptly the stretching action of the circuit of Fig. 1 so that the long residual signal is eliminated and essentially a square pulse of arbitrary duration will appear across capacitor C_1 . This is accomplished through use of the circuit shown in Fig. 2, wherein the delay line which may be either of the ordinary distributed or lumped-parameter type is used to control the time of application of a clamping signal to capacitor C_1 . The stretched pulse duration will be equal to the time delay introduced by the line.

The capacitor C_1 , which can be very small, is charged by the input pulse just as it was in Fig. 1, through diode V_1 . At the same time, the input pulse begins traveling down the delay line L . The voltage on C_1 after charging is complete begins to leak off very slowly through resistor R_1 . The time constant R_1C_1 can be made long so that during the time T_d equal to the delay in the line L the voltage on the capacitor has decreased, say, less than 1 percent.

At the time T_d the input pulse emerges from the line and is applied to the control grid of the clamp tube V_2 which in turn pulls all positive charge off capacitor C_1 and may charge the capacitor negatively, thus causing undershoot which may be eliminated by a second clamping diode V_3 . In this manner one is able to produce an essentially rectangular pulse of amplitude equal to that of the input pulse with time duration T_d and rise and decay times about equal to the rise time of the input pulse provided this rise time is not less than approximately 10^{-8} sec.

Where time durations greater than those easily obtained by a delay line are required, the line may be replaced by a univibrator whose differentiated trailing edge may be used to trigger the clamp tube V_2 .

It is interesting to note that when the pulses to be stretched are

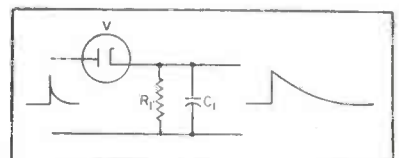

FIG. 1—Peak detector pulse stretcher

WHY YOU CAN DEPEND ON ALSIMAG[®]

New designs submitted to American Lava Corporation are studied:

1. To see if ALSIMAG components will do the job required.
2. For the practicality of producing the design in our materials by our processes.
3. To learn if the design can be simplified to reduce cost or speed delivery.
4. For the best production methods.
5. To determine when production will be available for the job.

All this takes a little time. But it gives you information you can depend on. With two new plants in production we can now give you favorable delivery dates on most requirements.

In addition you get:

1. Engineering know-how accumulated during half a century of specialization.
 2. Unexcelled production facilities.
 3. The widest choice of ceramic materials available in the industry.
 4. Equipment of a size and completeness that can handle YOUR job.
 5. Research which has constantly improved known ceramics and has led in the development of new special-purpose ceramics.
 6. The highest quality custom made ceramics, delivered when and as promised.
- Send us your problem. Let us show you what we can do for you.

50TH YEAR OF CERAMIC LEADERSHIP

AMERICAN LAVA CORPORATION

CHATTANOOGA 5, TENNESSEE

OFFICES: METROPOLITAN AREA: 671 Broad St., Newark, N. J., Mitchell 2-8159 • PHILADELPHIA, 1649 North Broad St., Stevenson 4-2823
SOUTHWEST: John A. Green Co., 6815 Oriole Drive, Dallas 9, Dixon 9918 • NEW ENGLAND, 1374 Massachusetts Ave., Cambridge, Mass., Kirkland 7-4498
LOS ANGELES, 232 South Hill St., Mutual 9076 • CHICAGO, 228 North LaSalle St., Central 6-1721 • ST. LOUIS, 1123 Washington Ave., Garfield 4959



General Industries'
Model TR 3-Speed Phonomotor

Dependability...

an important reason why leading manufacturers prefer General Industries' 3-Speed Phonomotors

Year after year, General Industries' *Smooth Power* Phonomotors provide trouble-free performance—backing up fine radio, television and record-changer engineering with highest quality motor design and construction.

Write for complete information, including specifications, design features and dimensions. Quantity price quotations available on request.



THE GENERAL INDUSTRIES CO.
Department MA, Elyria, Ohio

Where the
Requirements
are Extreme...

Use
**SILVER
GRAPHALLOY**

For extraordinary
electrical performance



THE SUPREME BRUSH
AND CONTACT MATERIAL

for **BRUSHES**

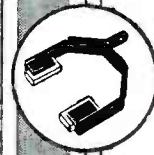

- for high current density

- minimum wear



- low contact drop

- low electrical noise

- self-lubrication

for
CONTACTS



- for low resistance

- non-welding character



* Graphalloy is a special silver-impregnated graphite

Accumulated design experience counts — call on us!

**GRAPHITE METALLIZING
CORPORATION**

1055 NEPPERHAN AVENUE, YONKERS 3, NEW YORK

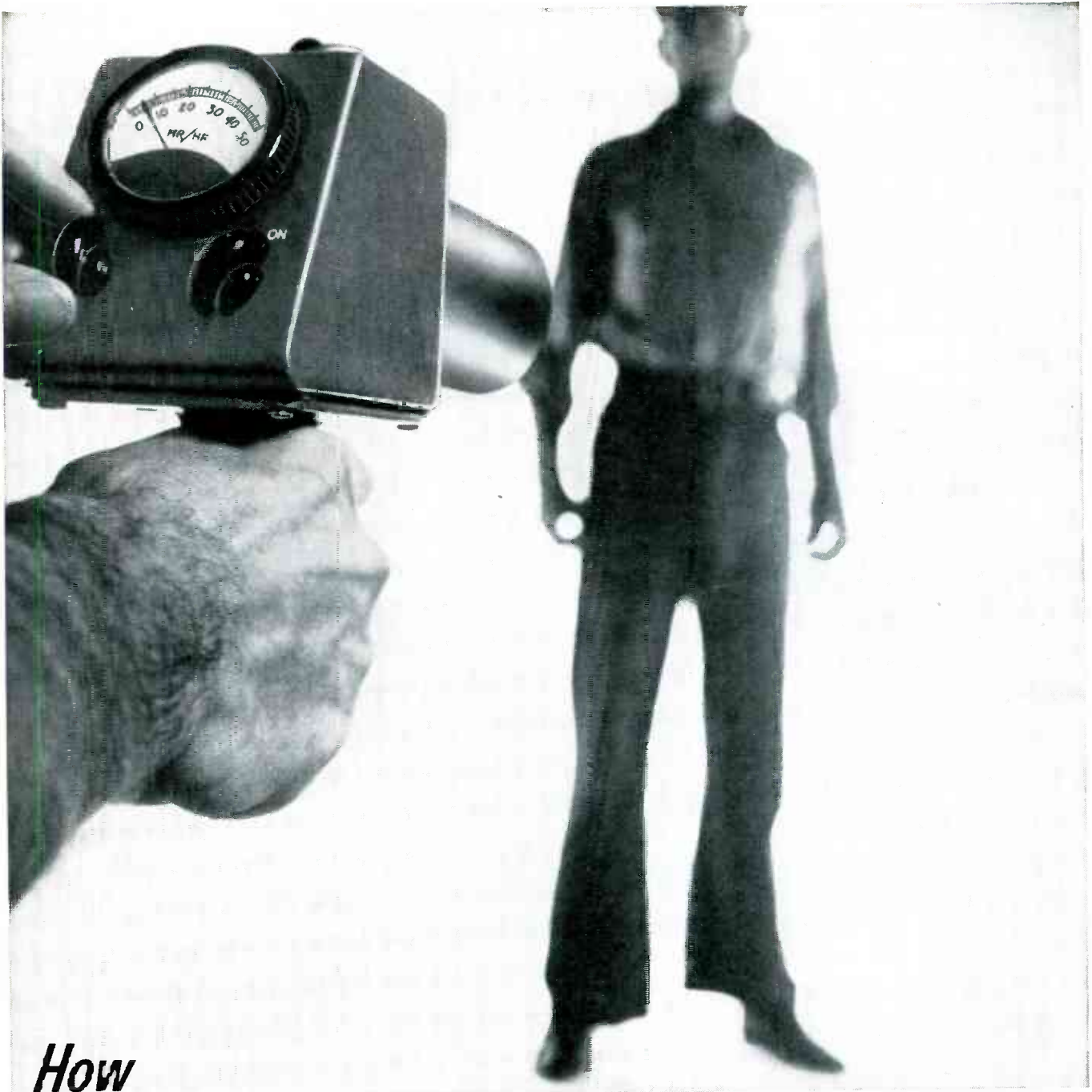

How to catch an atomic killer!

Today, there's a potential killer in labs and factories — radioactivity!

But atom workers are safe — thanks to the weapons of science.

Besides every precaution, workers get daily check-ups with ion-chamber "guns" and other radiation-detection instruments. They catch the killer before it strikes!

With atomic industry booming, demand for nuclear instruments is great.

Delivery must be certain — and it must be *fast*.

That's why, when shipping these and other precision instruments, both shipper and receiver stamp their orders: via Air Express!

The world's fastest shipping service brings this vital equipment safe, sound and *soon* to laboratories and defense production centers everywhere.

Whatever your business, *you* can profit from regular use of Air Express. Here's why:

IT'S FASTEST — Air Express gets *top priority* of all commercial shipping services — gives the fastest, most complete door-to-door pick-up-and-delivery service in all cities and principal towns at *no extra cost*.

IT'S DEPENDABLE — Air Express pro-

vides one-carrier responsibility all the way and gets a *receipt upon delivery*.

IT'S PROFITABLE — Air Express service costs less than you think, gives you many profit-making opportunities.

For more facts, call Air Express Division of Railway Express Agency.



AIR EXPRESS
GETS THERE FIRST

ORTHO-SIL...

Oriented Thin Steel Laminations



OrthoSil is Thomas & Skinner's new 4 mil orthographic iron-silicon laminations for high frequency inductors. The laminations have exceptionally high permeabilities from very low to very high inductions with correspondingly low core losses. OrthoSil is oriented to provide directional magnetic characteristics.

Developed primarily for frequencies of 400 to 2000 cycles, these thin laminations are also adaptable to the audio ranges.

Thomas and Skinner is producing

Specialists in Magnetic Materials—Permanent Magnets and Laminated Cores



THOMAS & SKINNER Steel Products Company
1120 East 23rd Street • Indianapolis, Indiana

OrthoSil laminations in standard as well as in special shapes. Our UI and EE series are designed especially for the OrthoSil, and are excellent for 400 cycle applications. These silicon steel laminations will frequently replace scarce nickel materials.

Transformers, such as power and 3 phase, chokes, saturable reactors and filters are but a few of the many electrical components for which OrthoSil is designed.

Write today for bulletin giving electrical characteristics and other pertinent data on OrthoSil oriented laminations.

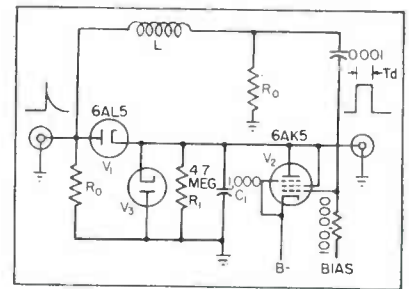

FIG. 2—Line-terminated pulse stretcher

of sufficient amplitude and a small amount of residual signal is tolerable, the plate-supply voltage for the clamp tube V_2 may be derived solely from the charge on capacitor C_1 . The circuit described has proven to be both reliable and flexible in its applications and may be used to stretch pulses by as much as a factor of 1,000 in a single step since the discharging impedance can be made very large permitting fast charging of the correspondingly small stretching capacitor.

REFERENCE

(1) J. F. Craib, Improved Pulse Stretcher, *ELECTRONICS*, p 129, June 1951.

Control System for Induction Heaters

WHEN SILVER SOLDERING or brazing near rubber or plastic insulation, the operation should be completed as rapidly as possible to avoid damage to the insulation and to the parts being brazed or soldered. The control system to be described reduces the power when the desired temperature has been reached and disconnects the power when the braze is completed.

The system arrived at controls power up to 40 kw at 10 kc. Full power is first made available and then reduced to the level required to keep the temperature constant at the operating point. When the operation is completed, a detector circuit turns off the power.

Operation

The radiation from the work is compared to that of a standard lamp to control the power fed to the work by the induction heater. A photocell, see Fig. 1, is switched back and forth between the work and lamp by means of a spinning

STOKES HIGH VACUUM EQUIPMENT... for every requirement of vacuum processing

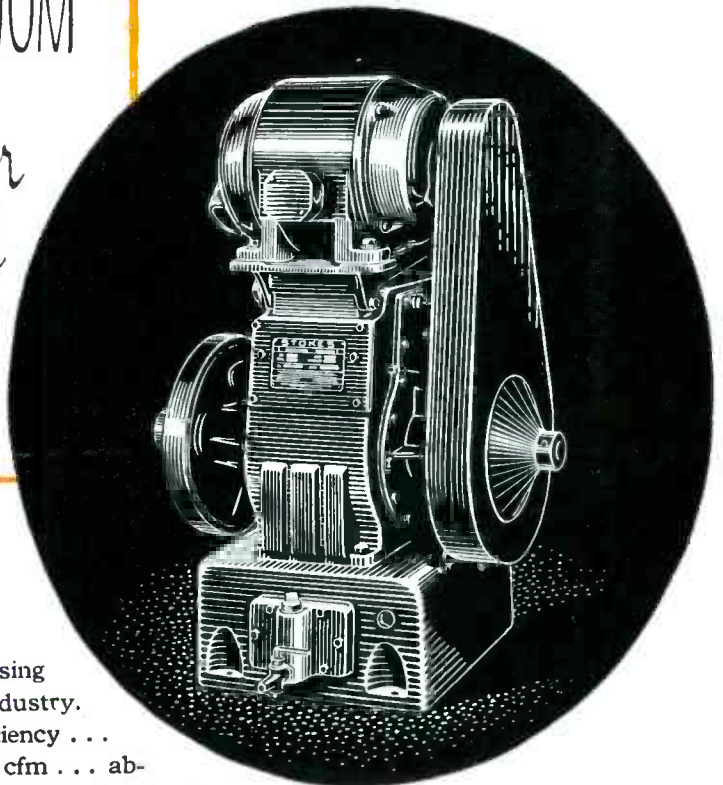

Stokes Microvac Pumps — basic to vacuum processing
—are designed for the broadest requirements of industry.
They have high volumetric and mechanical efficiency . . .

capacities of 15 to 500 cfm . . . ab-
solute pressures to 10 microns. Power
consumption is low. Compact design
with top-mounted motor requires minimum floor space.

Send for FREE Stokes
Vacuum Calculator. This
slide rule determines needed
pump capacity for any job . . . shows
Centigrade to Fahrenheit conversion.
Other useful conversion tables
and scales on reverse
of rule.



There are but four moving parts including the high speed, full-opening
exhaust valve of corrosion-resistant Teflon. Lubrication is completely
automatic, without packing, stuffing-boxes or grease fittings.
Wear is kept to a minimum, and long trouble-free service assured.
Parts are precision-finished, standard and interchangeable.

Stokes is the only manufacturer of equipment for complete vacuum
systems, including Microvac mechanical pumps, oil diffusion
pumps, McLeod Gages and Vacuum Valves.

Consult with Stokes on the application of vacuum to rotary exhaust
machines, house vacuum
systems, vacuum impreg-
nation, vacuum furnaces,
vacuum metallizing, and
to other applications in
which vacuum deserves
exploration.

STOKES MAKES

- Plastics Molding Presses,
- Industrial Tableting
and Powder Metal Presses,
- Pharmaceutical Equipment,
- Vacuum Processing Equipment,
- High Vacuum Pumps and Gages,
- Special Machinery

STOKES

F. J. STOKES MACHINE COMPANY, 4046 TABOR ROAD, PHILADELPHIA 20, PA.



when line "feathers" make
the feathers fly...

... Switch to Arkwright Tracing Cloth! You can re-ink clean, sharp lines over any erasure without "feathering" or "blobbing" to spoil your work.

Painstaking Arkwright inspection guards your drawings against pinholes, thick threads or other imperfections—Arkwright quality insures them against brittleness, opaqueness, or paper-fraying due to age. That is why Arkwright Tracing Cloth takes clean, sharp drawings that yield clear, sharp blueprints years after you make them.

Remember: if your work is worth saving, put it on Arkwright Tracing Cloth. Would you like a sample? Write Arkwright Finishing Co., Industrial Trust Bldg., Providence, R. I.



ARKWRIGHT
Tracing Cloths

AMERICA'S STANDARD FOR OVER 25 YEARS

*Want to know
about the . . .*

Augetron
Eccles-Jordan Circuit
Kathetron Tube
Mekapion Tube
Permatron
Petoscope
Schlieren Method
Scophony
Sema-graph
Sirufer
Syndec
Theremin
Tratonium
Voder

*or other early
electronic
developments?*



You can find out about
them in the early issues
of **ELECTRONICS**



The cumulative index to
ELECTRONICS' first decade,
pages C-1 to C-36
in the 1951-1952
electronics **BUYERS' GUIDE**
tell you where to look



Boost

feeble
input signals
with

Sensitrol[®] ultra-sensitive relays.....

How many devices do *you* know of that use an amplifier to boost a feeble input signal up to where it will operate a relay? Most of them would be more reliable . . . more compact . . . more economical—if the amplifier could be omitted.

It can be omitted! For rugged Weston Sensitrol Relays operate reliably on input signals as slight as *1 millivolt* or *½ micro-ampere*, handle substantial wattage *at 110 volts!* They require no power for excitation.

Engineering assistance is freely offered to help you adapt these Sensitrol Relays to present products, or any new problems you may have in mind. Simply consult your nearest Weston Representative, or write Weston Electrical Instrument Corporation, 595 Frelinghuysen Avenue, Newark 5, New Jersey . . . manufacturers of Weston and TAGliabue instruments.

A Type for Every Need

So sensitive that they operate direct on the output of a photo-electric cell or thermocouple, Sensitrol relays enable the instrument engineer to dispense with amplifiers, vacuum tubes and auxiliary power supplies. Single or double contacts, fixed or adjustable, manual or solenoid reset. Be sure you have a copy of Bulletin B-25-B, which gives detailed data on Sensitrol and other Weston relays.

WESTON *Instruments*

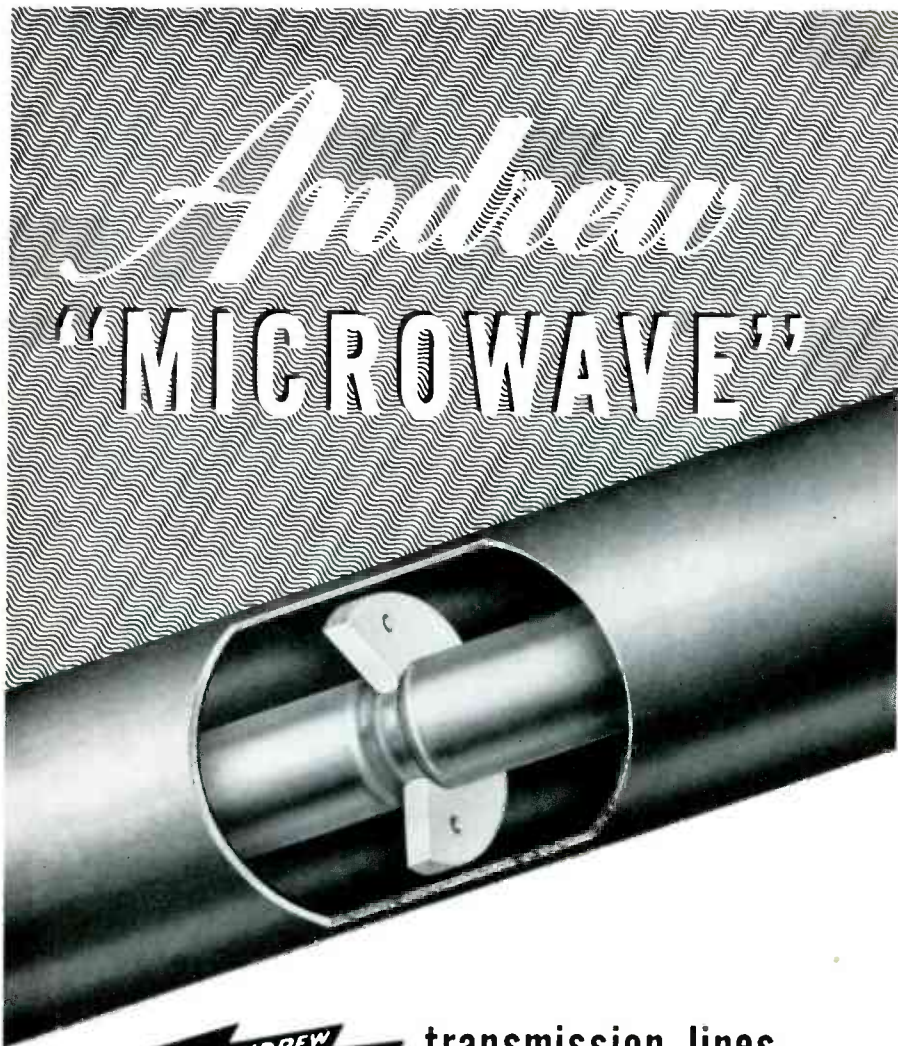

ANDREW transmission lines

Andrew Type 551 coaxial transmission lines feature insulators of **TEFLON***—the remarkable dielectric which has high voltage breakdown and extremely low power loss. These 1 5/8" diameter, 51.5 ohm lines are ideal for microwave applications.

ATTENUATION LESS THAN 1 DB PER 100 FT AT 2000 MCS
In addition to the excellent low loss factor of **TEFLON***, Andrew compensates by undercutting the inner conductor thus minimizing impedance discontinuities. The result is a line having the high efficiency and low VSWR required for microwave applications. A complete line of accessories is available. Write For Further Information.

*TRADE-MARK FOR DU PONT TETRAFLUOROETHYLENE RESIN

Andrew
CORPORATION

363 EAST 75TH STREET, CHICAGO 19

ANTENNA SPECIALISTS

TRANSMISSION LINES FOR AM-FM-TV-MICROWAVE • ANTENNAS • DIRECTIONAL ANTENNA EQUIPMENT • ANTENNA TUNING UNITS • TOWER LIGHTING EQUIPMENT

BURTON BROWNE ADVERTISING

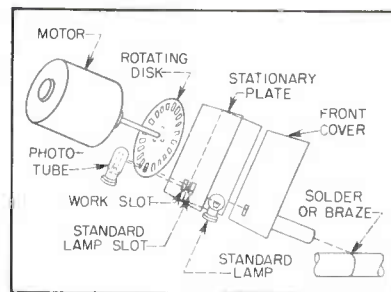

FIG. 1—Optical commutator for temperature control

slotted disk. The slots in the stationary plate are aligned with those of the disk. The lamp is behind one stationary slot and the work is behind the other. As a disk slot scans across the two stationary slots, a wave shape of the incident light on the photocell is produced.

A separate lamp, in addition to the standard lamp, radiates through another portion of the rotating disk into a second photocell. A reference wave is produced by this lamp to perform switching functions in the electrical circuit. The reference wave has a frequency of 600 cps with the disk rotating at 1,800 rpm.

Figure 2 shows a block diagram of the temperature-control system. The preamplifiers are located in the viewing unit. The control and amplifier unit also contains the circuits for the delay feature which disconnects the power when the braze is completed.

The phase-sensitive rectifier is an important part of the system. It is fed by a temperature-comparison signal and the phase-reference signal from the respective preamplifiers. The phase-sensitive rectifier rectifies these two signals and develops a d-c output voltage proportional to the magnitude and phase sense of the temperature com-

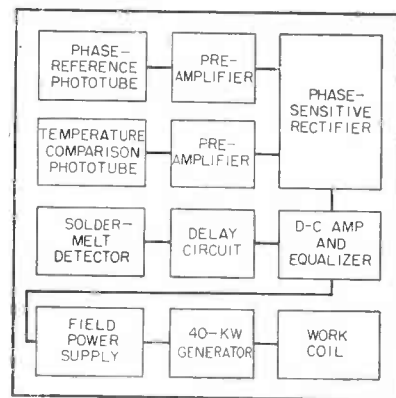

FIG. 2—Block diagram of temperature-control system

Stupakoff Printed Circuits

*Save space and weight
Speed Assembly
Reduce Costs
Minimize Assembly errors*

Soldered connections are reduced by 25% to 80%, assemblies are lighter and more compact, your production time is reduced and better products are made when Stupakoff Printed Circuits are used. These sturdy, compact, accurately produced units combine resistors and capacitors of precision values, in circuits designed in accordance with the requirements of individual applications. One Stupakoff Printed Circuit will replace

many individual components, with consequent simplification of the assembly and reduced costs.

Send for Bulletin →

Contains complete specifications of a number of typical standard circuits and detailed information on the design and construction of Stupakoff Printed Circuits. Ask for Bulletin 1151.



STUPAKOFF Products for Electrical and Electronic Applications

ASSEMBLIES—Metallized ceramic induction coils and shafts; metallized plates for fixed rigid assemblies; ceramic trimmer condensers.

CERAMICS—Precision-made ceramic products for electrical and electronic applications, all voltages, frequencies and temperatures.

RESISTOR CERAMICS—Used for temperature indicating or measuring equipment, for infrared light source and for heating elements. Complete with terminals, in the form of rods, tubes, discs, bars, rings, etc.

CERAMIC DIELECTRICS—For by-pass, lead-through, blocking, stand-off and trimmer applications. Temperature compensating Ceramic Dielectrics and high K materials. Tubes, discs and special shapes, plain or silvered.



STUPALITH—Will withstand extreme thermal shock. May be made to have zero, low-positive or negative expansivities. Safely used at temperatures up to 2400° F.

SEALS, KOVAR-GLASS—Terminals, Lead-ins; Stand-offs—for hermetically sealing and mechanical construction in radio, television, electronic and electrical apparatus. Single or multiple terminal units, in a wide variety of sizes and ratings.

KOVAR METAL—The ideal alloy for sealing to hard glass. Used for making hermetic attachments. Available as rod, wire, sheet, foil—or as cups, eyelets and other shapes.

STUPAKOFF CERAMIC & MFG. CO., Latrobe, Pennsylvania

YOUR COIL CAN BE WOUND FASTER, CHEAPER, EASIER ON A GEO. STEVENS WINDER!

- **MORE OUTPUT... LOWER COSTS...** from **EXCLUSIVE SPEED FEATURE.** Variable speed motors permit speed changes without changing belts or pulleys. Coil design permitting, speeds as high as 7500 RPM are not uncommon.
- **MUCH FASTER CHANGING OF SET-UPS.**
- **MUCH LOWER ORIGINAL COST.**
- **LONG LIFE.** Most of the original Geo. Stevens

Machines bought in 1936 are still operating daily at full capacity.

- **EASIEST TO OPERATE.** In one hour, any girl can learn to run a Geo. Stevens Machine.
- **MORE GEO. STEVENS** coil winding equipment is in use than all other makes combined.

**SOON TO BE ANNOUNCED
NEW TORROIDAL WINDING MACHINE**

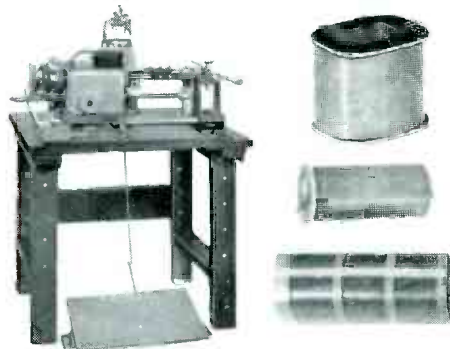

MODEL 117-A Automatic Heavy Wire Bobbin and Transformer Winder (Screw Feed)

—especially suited for winding heavy wire in tight, perfectly uniform layers for one or several Bobbin and Transformer Coils for regular production, laboratory or experimental use in *military and other types of equipment where space is limited.* Also winds single layer close or space wound coils.

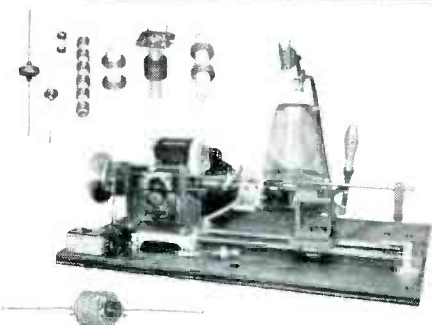

MODEL 120-A Universal Automatic Winder

—winds self-supporting, lattice wound universal coils. More than 2 universal coils may be wound simultaneously. Also winds R.F. Chokes, single or Pi-wound

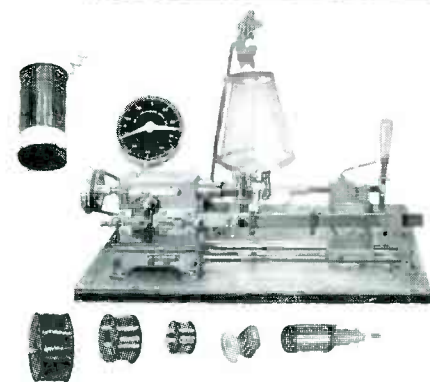

MODEL 112 Bobbin Winder

—winds all types of random wound Bobbin Coils; Solenoids; Repeater Coils.

NEW GEO. STEVENS CATALOG—
describes machines that wind practically every kind of coil for laboratory or production line. Write for your copy today.



*World's Largest Manufacturer
of Coil Winding Machines*

REPRESENTATIVES

Frank Tatro
6022 No. Rogers Ave., Chicago 30, Illinois
Insulation & Wires, Inc.
2240 E. Washington Blvd., Los Angeles 21, Calif
R. F. Staff & Co.
1213 W. 3rd St., Cleveland 13, Ohio

GEO. STEVENS

MFG. CO., INC.

Pulaski Road at Peterson
Chicago 30, Illinois



ELECTRONIC ENGINEERS

WHO WE ARE:

As a result of our recent affiliation with the Westinghouse Airbrake Co., we are entering a new and accelerated expansion program directed toward permanent growth in the industrial electronics field.

WHAT WE OFFER:

To qualified, competent engineers, we offer truly permanent positions at salaries that rank among the highest in the industry. Additional compensation is paid for the extended work week.

WHERE WE ARE:

We are located just outside Washington, D. C.—away from the hustle and bustle, yet close enough for you to enjoy all the advantages the nation's capital offers. Suburban housing in northern Virginia is available only a few minutes away from where we are located.

HERE'S ALL YOU DO:

If you have experience in any of the fields listed below, you owe it to yourself to investigate career opportunities here. Of course, all replies will be strictly confidential.

- Computers
- Radar Beacons
- Telemetering
- Sub-Miniaturization
- Microwave Receivers
- Microwave Transmitters
- Millimicrosecond Pulse Circuits
- Research in Underwater Sound Systems

Send resumes to: PERSONNEL DIRECTOR

MELPAR, INC.

452-A Swann Ave., Alexandria, Va.

For Communication Circuits **PRECISION** And For Networks

TOROIDAL INDUCTORS



by **FREED**

FREED TYPE

FREQUENCY

TI-1	Up to 15 KC
TI-2	Up to 75 KC
TI-3	Up to 200 KC
TI-3A	Up to 200 KC
TI-4	Up to 15 KC
TI-5	Up to 15 KC
TI-6	Up to 75 KC
TI-7	Up to 75 KC
TI-8	Up to 60 KC
TI-9	Up to 60 KC
TI-10	Up to 60 KC
TI-11	Up to 15 KC
TI-12	Up to 15 KC
TI-13	Up to 75 KC

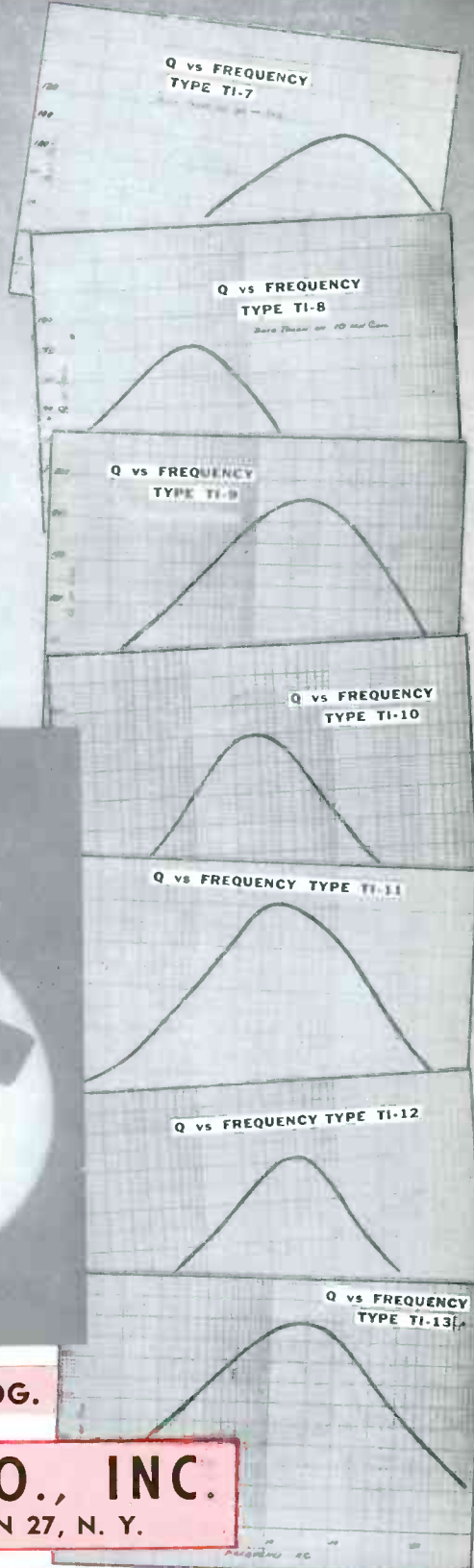
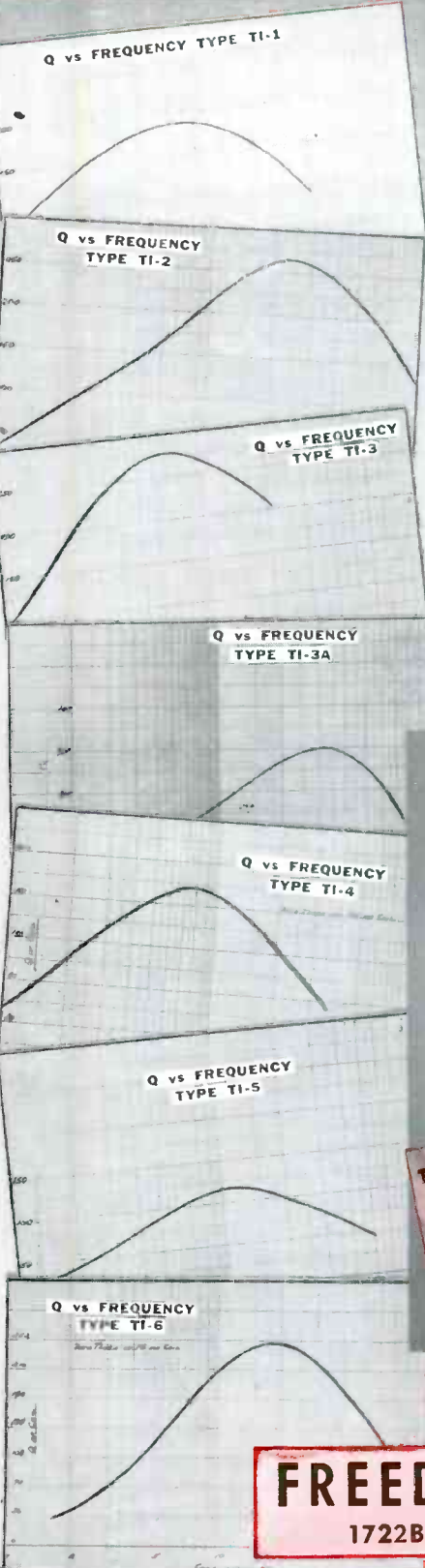

SEND FOR NEW COMPLETE CATALOG.

FREED TRANSFORMER CO., INC.
1722B WEIRFIELD ST., (RIDGWOOD) BROOKLYN 27, N. Y.

FREED TEST INSTRUMENTS — PRODUCTS OF EXTENSIVE RESEARCH



No. 1020 Megohmmeter



No. 1010 Comparison Bridge



No. 1030 Low Frequency "Q" Indicator



No. 1060 Vacuum Tube Voltmeter



No. 1110A Incremental Inductance Bridge



No. 1140 Null Detector



Decade Inductor 30 CPS to 300 KC

parison signal. The output voltage has one polarity if the braze requires more power. To reduce the heating power, the polarity is reversed. Magnitude of the voltage is proportional to the temperature unbalance between the work and the standard lamp.

The signal is next passed through an amplifier whose gain compensates for the effect of the inductance of the 40-kw generator field. The power delivered to the braze tends to lag the application of voltage to the generator field because of this inductance.

The material in this article was abstracted from an article in the *Bell System Technical Journal* for September, 1951, entitled "Induction Heater Control System" by R. W. Ketchledge.

Multichannel Remote Control System

By H. M. SCHWEIGHOFER and
A. H. WULFSBERG

*Engineering Division
Collins Radio Company
Cedar Rapids, Iowa*

IN THE DESIGN of remotely operated multichannel transmitting and receiving equipment, there is often a need for a device capable of turning a shaft to any one of a number of angular positions by remote control. The need is especially evident in the design of vhf and uhf aeronautical equipment for which frequency channels have been set up on a decimal basis.

A relatively simple mechanical device called the Autopositioner has been developed and successfully employed in a number of radio equipments for both commercial and military application. The system also shows promise in certain industrial control and indicating applications.

The basic elements of the device, as shown in Fig. 1, are a motor and its gear train, a torque-limiting clutch, a rotating shaft to which is fastened a notched stop-wheel, a pawl which engages the stop-wheel and a solenoid which actuates the pawl and also operates a pair of electrical contacts which control the motor. Associated with each unit is an electrical control system consisting of a remotely located selec-

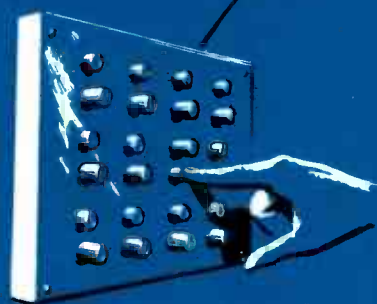

PROBLEM ... **Dependable remote control of complex circuits!**

SOLUTION ... **LEDEX CIRCUIT SELECTORS**

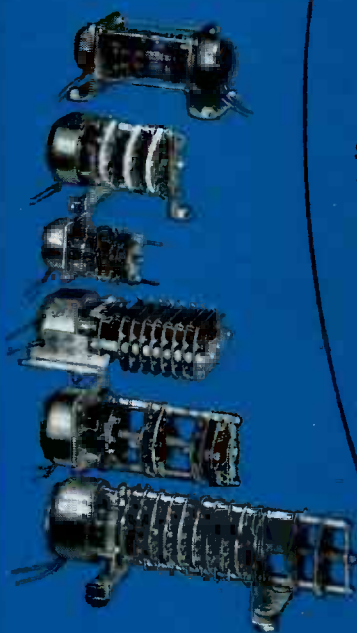

Leduc Circuit Selectors and Stepping Relays are widely used for remote control of complex circuits to assure top product performance. They are powered by dependable Leduc Rotary Solenoids . . . available with various types of mountings . . . will control practically any number of circuits . . . and can be custom-engineered to fit your product.

Let Leduc Engineers work with you to produce an efficient Leduc Circuit Selector or Stepping Relay for your product. Write today for complete information.

G. H. Leland INC.

123 WEBSTER STREET, DAYTON 2, OHIO

PROBLEM:

*How to braze silver contact to base metal
to get maximum bond area*

GENERAL PLATE

*Provided the solution with a special solder
and soldering technique*

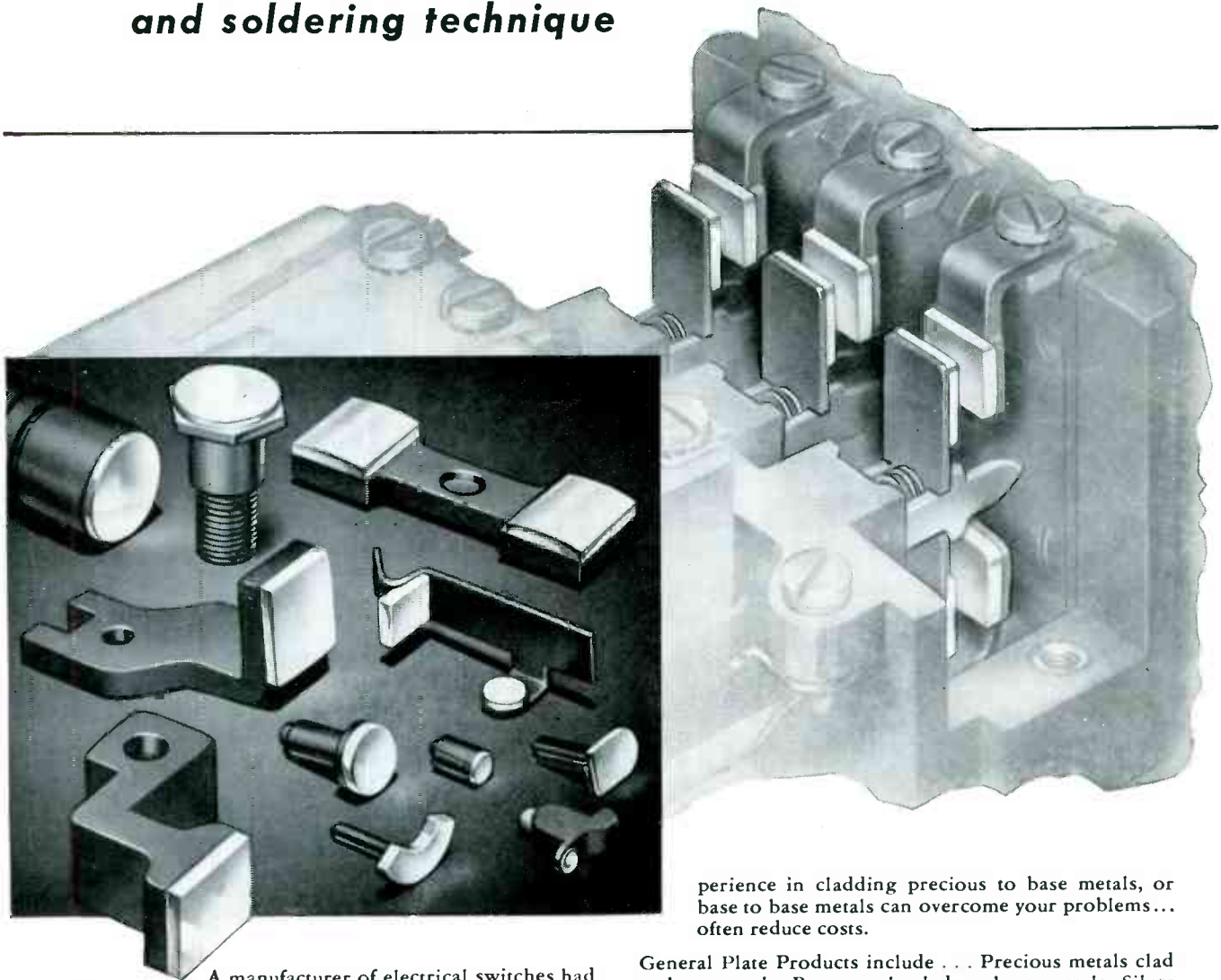

A manufacturer of electrical switches had difficulty in obtaining the required bond area in brazing a silver contact to a base metal part.

The problem was presented to General Plate engineers who provided the solution by developing a special solder and soldering technique. The result was a joint with 85% bond area which provided the necessary strength and electrical and thermal conductivity.

General Plate has extensive facilities for manufacturing brazed contact assemblies of various shapes. It will pay you to consult with General Plate on your problems.

And if you are concerned with composite metal problems, it will pay you to talk with General Plate. Their vast ex-

perience in cladding precious to base metals, or base to base metals can overcome your problems... often reduce costs.

General Plate Products include . . . Precious metals clad to base metals, Base metals clad to base metals, Silver solders, Composite contacts, buttons and rivets, Truflex® Thermostat Metals, Alcuplate®, Platinum fabrication and refining, #720 Manganese Alloy. Write for information.

*Have You a Composite Metal Problem?
General Plate can solve it for you*

GENERAL PLATE

*Division of Metals & Controls Corporation
32 FOREST STREET, ATTLEBORO, MASS.*

Sales Potentials are BIG in the NUCLEAR ENERGY FIELD

Newspapers carry headlines and a sprinkling of manufacturers have their fingers in the nuclear pie. That is the sum total in comparison to the vast numbers that should be directly concerned, that have even the slightest conception of the vast potentials of this new industry.

But it is big — fantastically big, and it's about time manufacturers became more accurately aware of their potential stake in this new and expanding market. So here are some figures to start thinking about.

One small atomic energy laboratory, and there are hundreds of them, has \$201,624.00 worth of technical equipment, \$207,915.00 worth of "special furniture". The 1,105 items of technical equipment range from an air relief bag to x-ray equipment, and include practically every type of instrumentation. Average cost per technical item is \$182.47. Furniture item is \$1,083.00.

Don't forget that while this is a lot of equipment, it's all in one small laboratory and that total industry will spend 7 billion in '52. That's quite a field in which to stake a claim.

and here's how to sell that field.

Admitted that the industry is big, but how does one go about selling it? Who are the manufacturers to contact — who in those firms are purchasing influences, and how does one get their product tried, proven and bought?

Most times the "right man" can't be seen and government channels can be labyrinths of wasted time. But these men must be seen and sold.

NUCLEONICS is the magazine those men look for and read, because it is the only one that serves their interest. Its nearly 7,000 subscribers are in every focal point of study, test and purchase. Products advertised within its pages are important to them because in this new science industry products new or established are carefully scanned for application as nuclear components or equipment.

If your products fall within any of the basic classifications that follow...

Air Cleaners	Ceramics	Motors
Amplifiers	Chronographs	Ovens
Analyzers	Containers	Phosphors
Balances	Controls	Plastics
Bearings	Detectors	Power Supplies
Bellows	Electron Tubes	Pyrometers
Blowers	Gages	Resistors
Bridges	Generators	Shielding
Burners	G-M Apparatus	Test Chambers
Bushings	Insulators	Testers
Cameras	Ionization Chambers	Tile
Capacitors	Metals	Timers
Carboys	Mixers	Transformers
Centrifuges	Monitors	X-Ray

to mention only a few

Then you can sell it most effectively in the nuclear field through...

For further information on the scope of the nuclear market, consult any NUCLEONICS representative for additional data. Complete data on the new enlarged NUCLEONICS is also available from him or write direct to our New York office.

NUCLEONICS



A McGraw-Hill
Publication



330 W. 42nd St., N. Y. 36, N. Y.

WESGO CRACK- PROOF CERAMIC SHAPES FOR Furnace Brazing

Withstand any amount of thermal shock without cracking. Proven superior to carbon or metal brazing fixtures in positioning vacuum tube components for furnace brazing.

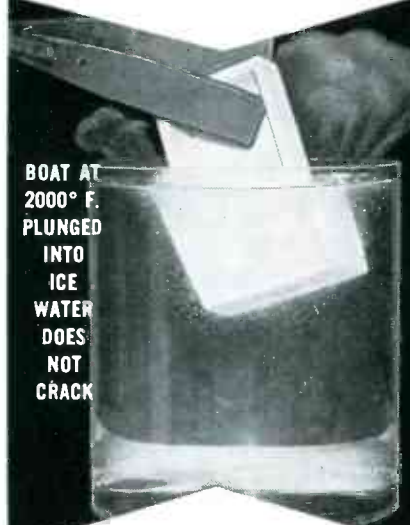

BOAT AT
2000° F.
PLUNGED
INTO
ICE
WATER
DOES
NOT
CRACK

- Non reactive with any metals
- Retains shape at high temperatures
- Clean . . . will not rub off on hands and work pieces
- Permanent . . . do not react with air or reducing gases

Available in stock forms of boats or slabs. Special shapes made to your individual specifications.

WRITE FOR DETAILS

WESTERN GOLD &
PLATINUM WORKS

589 Bryant Street • San Francisco, Calif.

AVAILABLE WITH VARIOUS STANDARD COMPONENTS TO MEET ANY REQUIREMENT

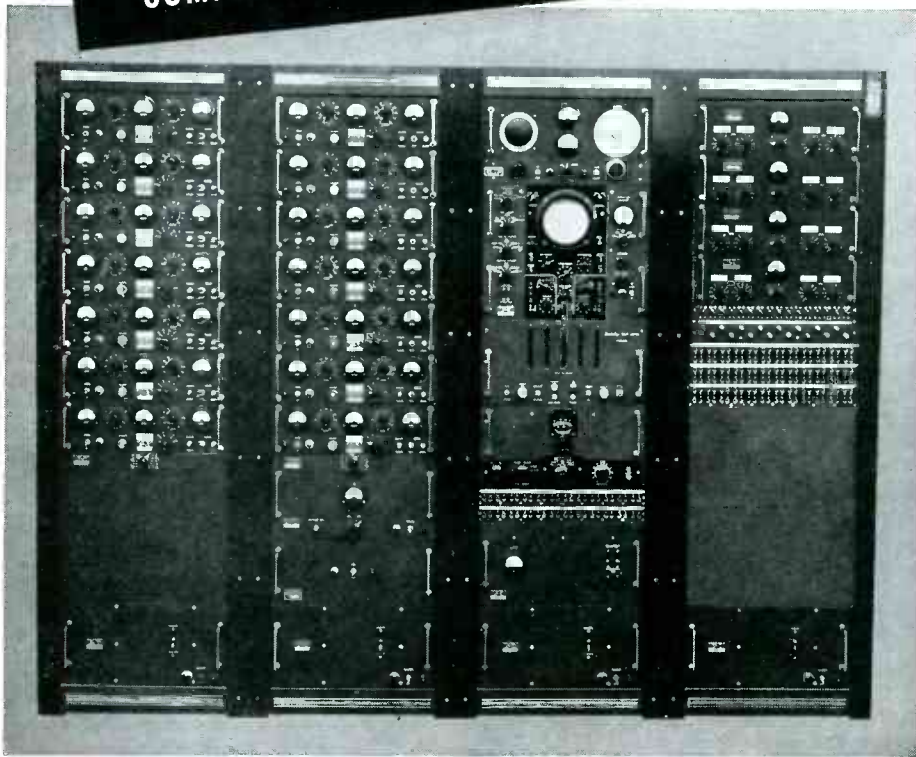

Typical Bendix 14-band Telemetry Receiving Station. Other standard component configurations can provide for reception of fewer subcarrier bands, or decommutation of up to 27 channels can be added.

Bendix-Pacific FM/FM TELEMETERING RECEIVING STATIONS

Advanced engineering features in this new equipment combine to produce the highest degree of reliability, accuracy and ease of operation in the reception and recording of telemetering signals.

The stations receive frequency-modulated radio signals employing continuous or commutated subcarriers. Any of the 18 standard subcarrier oscillator bands are available and a maximum of 14 continuous subcarriers can be received and recorded simultaneously by means of standard plug-in assemblies. Up to 27 signal channels can be separated from commutated subcarriers with each signal being recorded as a continuous trace. Reliability is assured by circuits which maintain synchronization even in the presence of noise or failure of an individual telemetering channel.

The equipment is designed to provide long life under continuous operation. Special attention has been given to ease of operation and service in the field.

Write for complete information



TO MEASURE...TO WARN...TO INDICATE...AT A DISTANCE

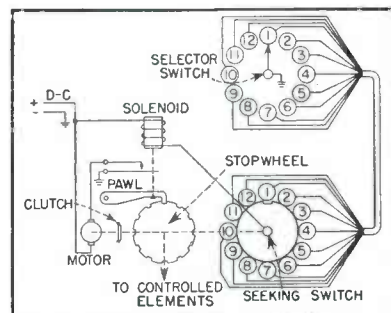

FIG. 1—Functional diagram of the system

tor switch and a "seeking" switch operated by the rotating shaft.

The control system is designed so that whenever the selector switch and seeking switch are not set to the same electrical position, the solenoid is energized, causing the unit to operate and drive its shaft to the proper position to restore the symmetry of the circuit.

The system illustrated in Fig. 1 is of the simple "open-seeking" type in which one control wire is required for each controlled position. The remote selector switch grounds one control wire, closing the solenoid circuit, until the seeking switch is driven to the proper position to open the circuit. The solenoid then permits the pawl to drop into the selected stop-wheel notch and accurately position the shaft.

To reduce the number of control wires to a practical minimum and still retain the advantages of positive control, a special system to be described later has been developed which uses the control wires in binary combinations.

Because of the use of a wedge-shaped pawl to engage the stop-wheel notches, the accuracy with which the unit can be made to repeat a position can be held to better than 0.05 deg rotation.

To absorb the kinetic energy of the motor when the pawl stops the positioned shaft and to permit the operation of two or more auto-positioner units from a common drive motor, each unit is provided with a clutch of the de-energizing type.¹

To provide a positive method of controlling the units using a minimum number of control wires, a special binary control system has been developed. This system can

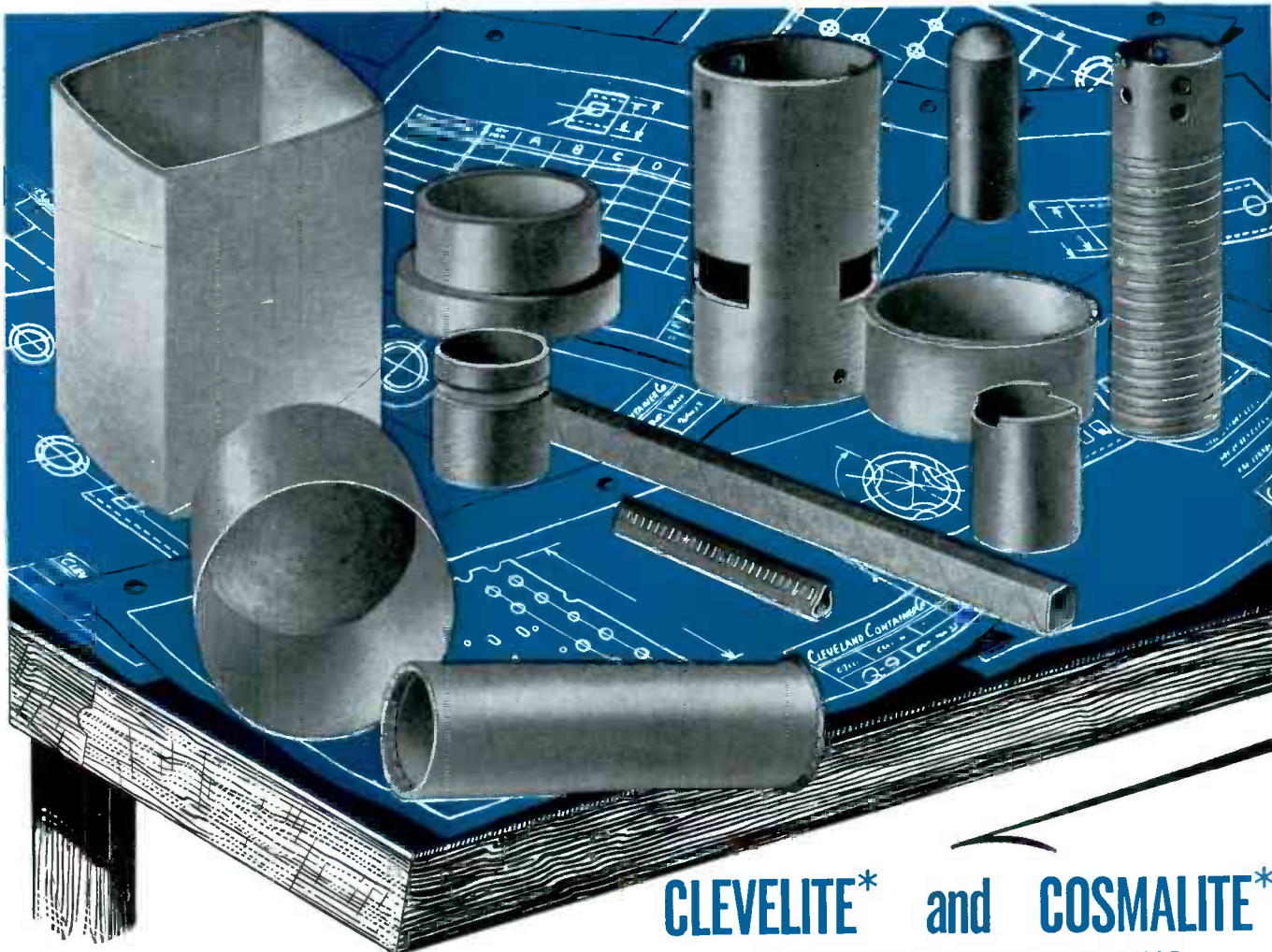

A GRADE FOR EVERY NEED!

Available in diameters, wall thicknesses and lengths to meet regular or special adaptations.

CLEVELITE

- Grade E.....Improved post cure fabrication and stapling.
- Grade EX.....Special grade for TV deflection yoke sleeve.
- Grade EE.....Improved general purpose.
- Grade EEX.....Superior electrical and moisture absorption properties.
- Grade EEE.....Critical electrical and high voltage applications.
- Grade XAX.....Special grade for government phenolic specifications.

COSMALITE

- Grade SP.....Post cure fabrication and stapling.
- Grade SS.....General purpose.
- Grade SSP.....General purpose — punching grade.
- Grade SLF.....Thin wall tubing — high dielectric and compression strength.

CLEVELITE* and COSMALITE*

LAMINATED PHENOLIC TUBING

... meets the most exacting requirements of the electronic and electrical industries!

Whether to insulate the live electrical parts of a rectifier, a high voltage transformer, or any one of countless other applications ... satisfaction is ensured.

For wherever physical strength, low moisture absorption, high dielectric strength, low loss and good machineability are of prime importance ... the combined electrical and physical properties of CLEVELITE and COSMALITE are essential.

DEPENDABLE • ECONOMICAL • LONG LASTING
Why pay more? ... for the best call CLEVELAND

* Reg. U. S. Pat. Off.

Cleveland Container Co. is known
for its **EXCELLENT SERVICE** and
PROMPT DELIVERIES.

See our exhibit #207 at
The Radio Engineering Show
in New York City, March 3-6

The CLEVELAND CONTAINER Co.
6201 BARBERTON AVE. CLEVELAND 2, OHIO

PLANTS AND SALES OFFICES at Plymouth, Wisc., Chicago, Detroit, Ogdensburg, N.Y., Jamesburg, N.J.
ABRASIVE DIVISION at Cleveland, Ohio

CANADIAN PLANT: The Cleveland Container, Canada, Ltd., Prescott, Ontario

REPRESENTATIVES

NEW YORK AREA R. T. MURRAY, 604 CENTRAL AVE., EAST ORANGE, N. J.

NEW ENGLAND R. S. PETTIGREW & CO., 62 LA SALLE RD., WEST HARTFORD, CONN.

CHICAGO AREA PLASTIC TUBING SALES, 5215 N. RAVENSWOOD AVE., CHICAGO



now
**a COMPLETE
 TYPE TESTING
 LABORATORY**
*from ONE
 source*



Bowser is the only manufacturer today who can provide a COMPLETE line of type testing equipment, custom engineered to individual requirements. Bowser environmental simulation units meet all MIL, JAN, USAF, AN and other Government specifications for testing equipment.

In addition to a complete range of standard models, Bowser can provide special equipment, with special accessories if necessary, to meet individual requirements of temperature, humidity, altitude, sand and dust etc. Bowser's Engineering staff invites you to take advantage of their long continuous experience, the most versatile in the field.

✓ CHECK AND MAIL TODAY

BOWSER TECH. REFRIG., Terryville, Conn.

Send information on test equipment checked:

- | | |
|--|--|
| <input type="checkbox"/> High Temperature | <input type="checkbox"/> Fungus Resistance |
| <input type="checkbox"/> Low Temperature | <input type="checkbox"/> Rain and Sunshine |
| <input type="checkbox"/> Temperature Shock | <input type="checkbox"/> Sand and Dust |
| <input type="checkbox"/> Humidity | <input type="checkbox"/> Immersion |
| <input type="checkbox"/> Altitude | <input type="checkbox"/> Explosion Proof |
| <input type="checkbox"/> Walk-In Rooms | <input type="checkbox"/> Vapor Tight |
| | <input type="checkbox"/> Special Engineering |

Name _____ Pos. _____

Company _____

Street _____

City _____ Zone _____ State _____

BOWSER

TECHNICAL REFRIGERATION

DIVISION BOWSER INC.

TERRYVILLE • CONN.

TEFLON MAGNET WIRE

FOR HIGHEST TEMPERATURE APPLICATIONS

We invite inquiries where requirements call for:

small SPACE FACTOR

HIGHEST ABRASION RESISTANCE

FLEXIBILITY AND ADHERENCE

DIELECTRIC STRENGTH

RESISTANCE TO CHEMICALS

capable of withstanding temperatures of 250 centigrade.

WARREN WIRE COMPANY

POWNAI

VERMONT

Producers of Nylon, Plain Enamel, and Served Magnet Wire

Tinned and Bare Copper Wire.

GENERAL CONTROL COMPANY . . . OFFERS A complete line of Lever Switches

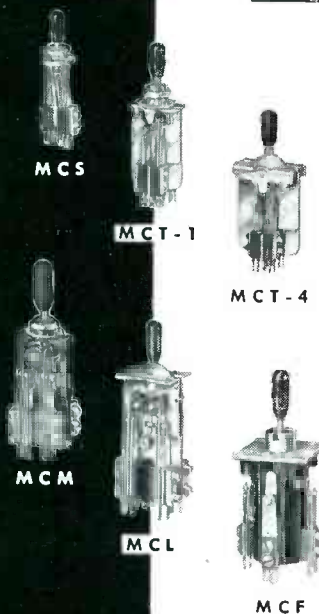

MCS A *new*, light-weight, miniature switch for instruments and communication systems. Positive lock or non-lock lever operation, various contact forms. Rating: 1 ampere.

MCT-1 Small size, telephone-type switch for control of multiple circuits. Single-hole mounting simplifies layout and fabrication of switchboard panels. Rating: 1 ampere.

MCT-4 Similar to MCT-1 but with two sets of four standard mounting holes. Static shield between contact assemblies for low-capacity circuits. Rating: 1 ampere.

MCM Utilizes a stainless steel detent and a ball for smooth, positive lever action. Waterproof lever, rotary, and angle actuators available. All parts non-corrosive. 5 amps.

MCL A heavy-duty switch for severe, constant use in electrical controls. Low-friction assembly, rugged cam, insure smooth lever action for complex buildups. 10 amps.

MCF Versatile switch; single hole mounting; one neutral and four switch positions. Lock or non-lock throw available, with any contact combination. Rating: 5 amps.

(All Ratings 125 volts a-c, n.i.)

Write for DATA SHEET E-100 today!

SPECIAL SWITCHES Our Engineering Department will be glad to supply information on *special* Lever Switches, and the use of various contact arrangements for other than manual actuation.

GENERAL CONTROL COMPANY

1200 SOLDIERS FIELD ROAD (Established 1934) BOSTON 34, MASS.

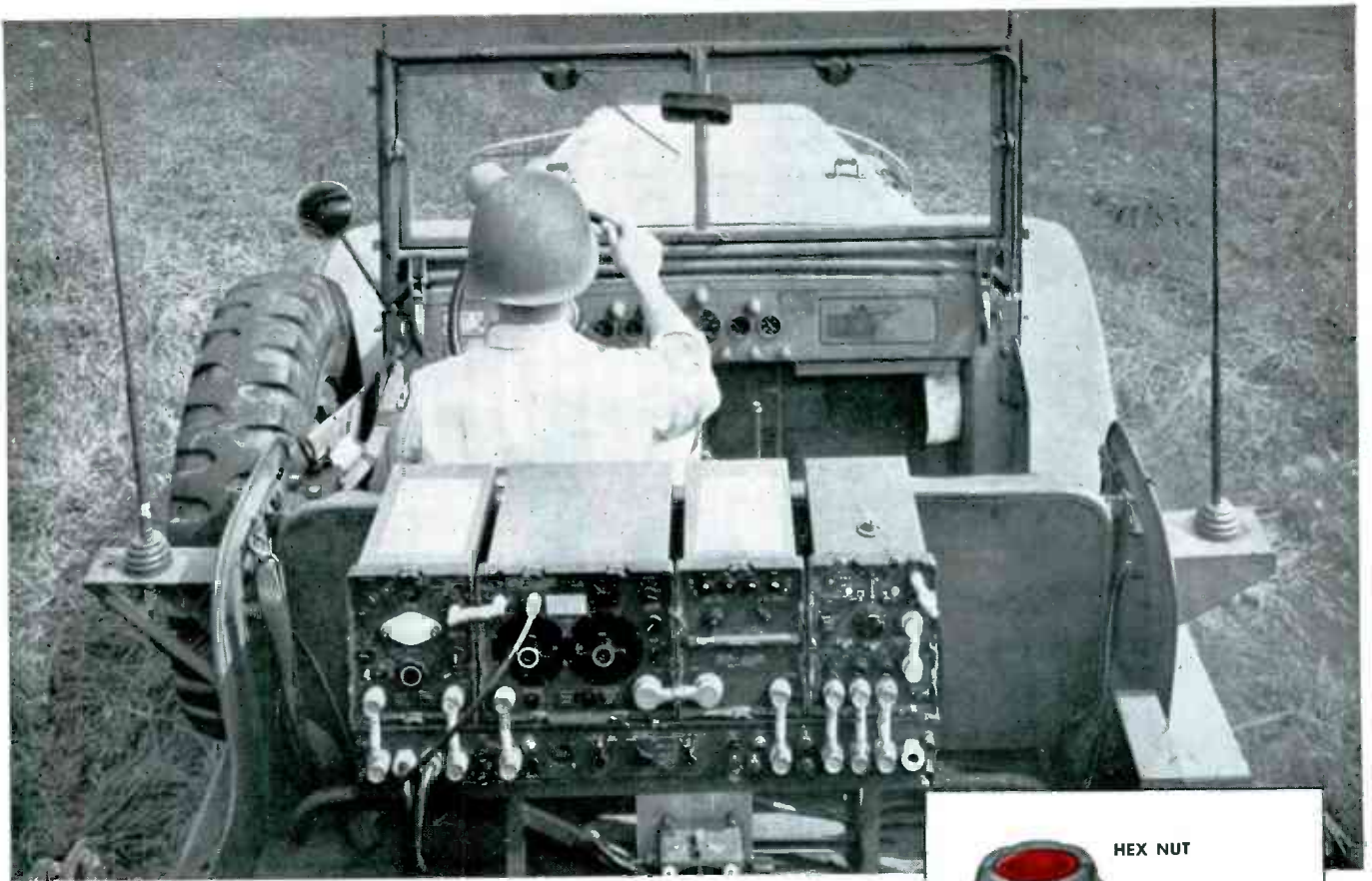

Guarding Signal Corps Equipment from Fastener Failure

Communications equipment for mobile tactical units must be sturdy enough to follow the front lines cross-country and along battle-pitted roads. This AN/GRC-3 radio equipment, installed in all types of combat vehicles, must be ready to provide communications liaison between advancing units. And it must be ready twenty-four hours a day, despite the roughest operating conditions. For vital equipment of this type there is a growing recognition of the need for self-locking fasteners to protect the expensive and critical component parts which make them function.

Helping to keep this equipment operating by holding against severe and long-continued vibration are many ESNA machine screw hex nuts and

clinch nuts. These Elastic Stop Nuts—with *fungus proof nylon inserts for extended reuseability*—offer the advantages of secure fastenings and at the same time simplify maintenance and field repairs.

ESNA HEX NUTS are quickly installed with power tools—permit accurate, precise adjustments, lock at any position along the bolt, and keep fastenings tight until deliberately removed.

ESNA CLINCH TYPE NUTS are available in various shank lengths for swaging on different gauges of sheet metal. Permanently clinched into place on frame members or to sections of the chassis, they provide permanent and pre-positioned fasteners for assembling panels or mounting component parts.



Red Nylon locking inserts
Reusable over 100 times

DESIGN AHEAD WITH ESNA

THE FAMOUS RED ELASTIC
COLLAR IS VISIBLE EVIDENCE
OF LOCKING SECURITY

Threadless and permanently elastic, it provides these 4 outstanding features:

1. Protects against nuts loosening due to VIBRATION
2. Keeps locking threads CORROSION FREE
3. Provides for accurate BOLT LOADING
4. Seals against LIQUID LEAKAGE along the bolt threads

And can be used again and again

Specify ESNA hex and clinch nuts with the new red nylon insert to assure adequate locking torque through hundreds of on-off applications.

When you design equipment that needs similar fastening security, specify Elastic Stop Nuts. For complete dimensional and installation data write to Elastic Stop Nut Corporation of America, Vauxhall Road, Union, N. J.



ELASTIC STOP NUTS

DESIGN HEADQUARTERS FOR VIBRATION-PROOF FASTENERS

ELECTRONICS — February, 1952

The Latest and Most Revolutionary Development
in COAXIAL RF SWITCHES...
Double Pole Double Throw!



FIRST CONCEIVED
FIRST DEVELOPED
FIRST PRODUCED
BY **TRANSCO**

RF PERFORMANCE CHARACTERISTICS

- ★ Frequency range up to 11,000 Mc./Sec.
- ★ V.S.W.R. less than 1.3 to 1.
- ★ Insertion loss less than .5 db throughout operating range.
- ★ Attenuation between unused connectors 55 db average.
- ★ Power handling capabilities equal to improved type N connectors.
- ★ Motor driven actuator rating 24-28 V.D.C.

TRANSCO Model 1460-22 Double Pole Double Throw coaxial RF switch replaces TWO Single Pole Double Throw Switches and provides substantial saving in weight and flexibility of installation.

TRANSCO coaxial switches are specified because in addition to outstanding performance characteristics, they incorporate such advanced features as (1) motor operated instead of solenoid, (2) straight end connections which eliminate the use of lossy angle connectors, save time and space, (3) simple and easy mounting.

TRANSCO offers a complete and unsurpassed line of coaxial RF switches, precision built for the most critical applications requiring efficient performance under extreme temperature and shock conditions. They meet or surpass the most exacting specifications.

Write for complete
engineering data
and counsel.

TRANSCO PRODUCTS, INC.

DESIGNERS & MANUFACTURERS OF MECHANICAL & ELECTRONIC AIRCRAFT EQUIPMENT

12210 NEBRASKA AVENUE, LOS ANGELES 25, CALIFORNIA

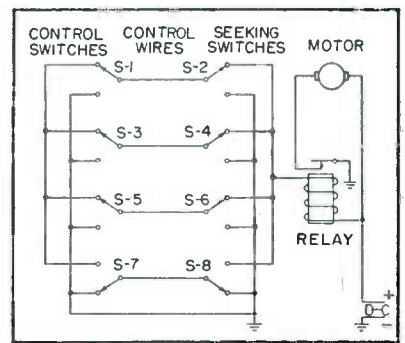

FIG. 2—Functional diagram of the binary control system

be understood best by considering a system of single-pole double-throw switches as shown in Fig. 2. Note that when the switches are set symmetrically (S-1 in the same position as S-2, etc.), there is no current path from the relay coil to ground and the motor will remain unenergized. If any one of the control switches is set to a position different from that of its seeking switch, a path to ground will be created and the motor will operate until the symmetry of the system is restored.

The total number of different combinations in a system such as this is equal to 2^n where n is the number of control wires used. In the case of the four-wire system shown, 16 combinations exist. However, one combination is not usable in this application. Consider what will happen if all the seeking switches were set to off. Then there can be no closed circuit regardless of how the control switches are set. Hence the maximum number of usable combinations is $2^n - 1$. A three-wire system can control 7 positions, four-wire 15 positions and a five-wire 31 positions.

The unit is adaptable for use with a number of different control systems.

REFERENCE

- (1) R. W. May and N. H. Hale, Automatic Positioning Control Mechanisms, *Electronic Industries*, Jan. 1946.

R-F Rewarming

THE DEPARTMENT OF SURGERY, University of Toronto, has been conducting experiments on r-f rewarming techniques. During the past year, results from tests conducted with animals indicate that the same procedure might be applied to the resuscitation of humans with low-

NEWS FLASH



FROM LONDON

ALUMINUM SOLDERING REVOLUTIONISED by world's first commercial **ULTRASONIC** soldering equipment



A PRODUCT OF MULLARD LTD.

IS the soldering of aluminum one of your production difficulties? Then here's the biggest—and best—news for you in years. The industrial problem of soldering aluminum and other metals that form refractory oxides has at last been overcome in a practical, commercial form by the use of ultrasonics.

The new soldering equipment developed in the Mullard Research Laboratories destroys oxide film by ultrasonic cavitation and provides a "clean" metallic surface.

The equipment comprises a small electronic amplifier, for supplying the ultrasonic power, and a soldering gun.

Two controls, a mains switch on the amplifier and a trigger on the gun, make the operation simple.

No flux is needed and standard soft solders can be used. Unskilled workers can operate the equipment with absolute ease and

safety. And, since the ultrasonic frequency employed is inaudible to the human ear, there is no discomfort to the operator.

Here is the practical solution to the tinning of aluminum and its alloys. The following are some of the companies who have been supplied with the equipment:

- Westinghouse Electric Corp.*
- North American Aviation Inc.*
- Sylvania Electric Products Inc.*
- Bell Telephone Laboratories Inc.*
- Boeing Airplane Company*
- Hamilton Watch Company*



The Mullard Ultrasonic Soldering Gun and Amplifier. The unit operates from A.C. mains and is robustly made to suit workshop conditions.

Isn't there a soldering problem it can settle for your company, too?

Deliveries can now be made immediately from stock.

Mail the coupon below for more details.



Mullard

ELECTRONIC TUBES · RADIO · TELEVISION · X-RAY TUBES · LAMPS
SCIENTIFIC INSTRUMENTS · COMMUNICATIONS EQUIPMENT · MAGNETIC
MATERIALS · ULTRASONIC GENERATORS

Mullard Overseas Ltd., Electronic Equipment Division, Century House,
Shaftesbury Avenue, London, W.C.2, England.

Mullard Overseas Ltd., Century House, Shaftesbury Avenue, London, W.C.2, England

ENQUIRIES IN U.S.A. TO International Electronics Corp., 137 Hudson Street, New York 13, N.Y.

Please send full information of the Mullard Ultrasonic Soldering Equipment to:—

NAME

COMPANY

ADDRESS

CITY STATE

(MRE105 REV.)



MACDONALD Proportional TEMPERATURE CONTROL

The THYRATRON Control allows PROPORTIONAL regulation of output power to electrically heated furnaces. Instead of turning current on-and-off, or adjusting the time of application of full power, the power level is continually monitored in accordance with the furnace demand. In this way the number of expansions and contractions of the heated elements is greatly reduced, increasing heater element life. The controller operates proportionally from a resistance thermometer, and thus insures maximum sensitivity of control.

SPECIFICATIONS:

Resistance Thermometer Actuated
Controls up to 7½ amperes @ 220V
Standard Ranges: —55 to 200°C; 0-1000°F; 0-1000°C
Controls to 0.1°C (0.01°C or better with improved furnaces)

W. S. MACDONALD CO., INC.

University Road • Cambridge • Massachusetts

**"IT'S GOTTA BE
RIGID and
FLEXIBLE—
TRANSPARENT
and
OPAQUE...
I BETTER GO
TO THE
PLASTICS SHOW!"**



Every facet of the vast plastics industry will be concentrated in Philadelphia's Convention Hall. You will see what's *new* in research, raw materials, machinery, and production techniques. If there's an answer to your problem in the plastics industry, you'll find it at the Exposition. *This exposition is not open to the public. Requests for admission tickets should be written on your company letterhead directed to THE SOCIETY OF THE PLASTICS INDUSTRY, Inc., 67 W. 44th Street, New York 18, N.Y.*

Something worth thinking about—

**ARE DAILY
ADJUSTMENTS
NEEDING
YOUR
OPERATING COSTS?**

There's a big factor showing up in the tape recording world... it's the tragedy of *High Maintenance Costs*. Many radio stations are confronted with the daily ritual of recorder checking and adjusting. Added to the time cost of such inspections is the cost of frequent parts replacements and loss of program time.

In contrast, Ampex users find their equipment will operate continuously eighteen hours a day with but infrequent inspection. Upkeep and replacements are almost nil; heads have remarkably long life. Ampex performance is constant over long periods of continuous operation. Long life with low maintenance is assured in each Ampex recorder by high manufacturing standards and complete test of each machine before shipment. It all adds up to one sure fact—Ampex quickly pays for itself out of savings from lower operating costs and added dependability.



**Model
300**

Complete Specifications on Request

Shown is the time proven Model 300 Console. Throughout the field of professional audio recording this machine is the recognized leader.

**1952 NATIONAL
PLASTICS
EXPOSITION**

**PHILADELPHIA
CONVENTION HALL
MARCH 11-14, 1952**

STANDARD OF THE GREAT RADIO SHOW



AMPEX ELECTRIC CORP.
Redwood City, California
Dealers in Principal Cities

AMPEX

Magnetic Tape Recorders

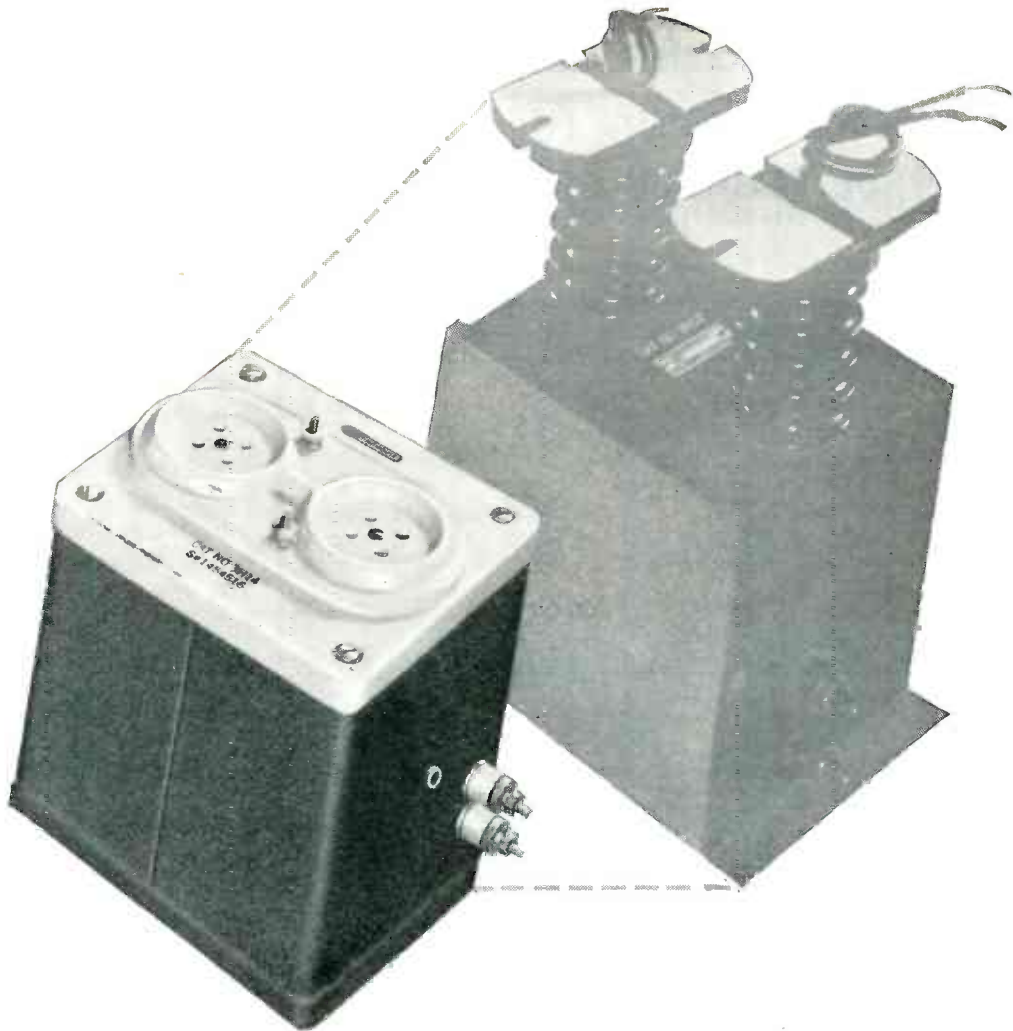

Making little ones out of big ones . . .

Many a design problem has been simplified by the Westinghouse ability to reduce transformer size and weight.

Here, for example, is a case where a transformer was required to work in a voltage-doubler circuit at 18,000 volts. The old model created a space problem.

First step in redesigning, Westinghouse engineers applied a smaller, lighter Hipersil® Core. That, plus improved insulation, made it possible to reduce coil size and spacing. Then a wet-process porcelain cap, with integral tube sockets, eliminated the need for stand-off insulators. The net result was an over-all reduction of 30% in both size and weight of the completed power unit . . . with a great big bonus: The saving to the equipment assembler in installation

costs alone made the new design highly profitable, because it was no longer necessary to wire tube sockets.

Savings like this are available to you, too. If size, weight, performance, or quantity production have any bearing on your transformer problem, call your Westinghouse representative, or write Westinghouse Electric Corporation, Specialty Transformer Department, Sharon, Pennsylvania.

J-70610



SAVE DRAFTING TIME

Right Way to MEASURE MACHINE SCREWS

By dimensioning and naming machine screws as indicated, you avoid misunderstanding, cut down on drawing changes and save time in purchasing.

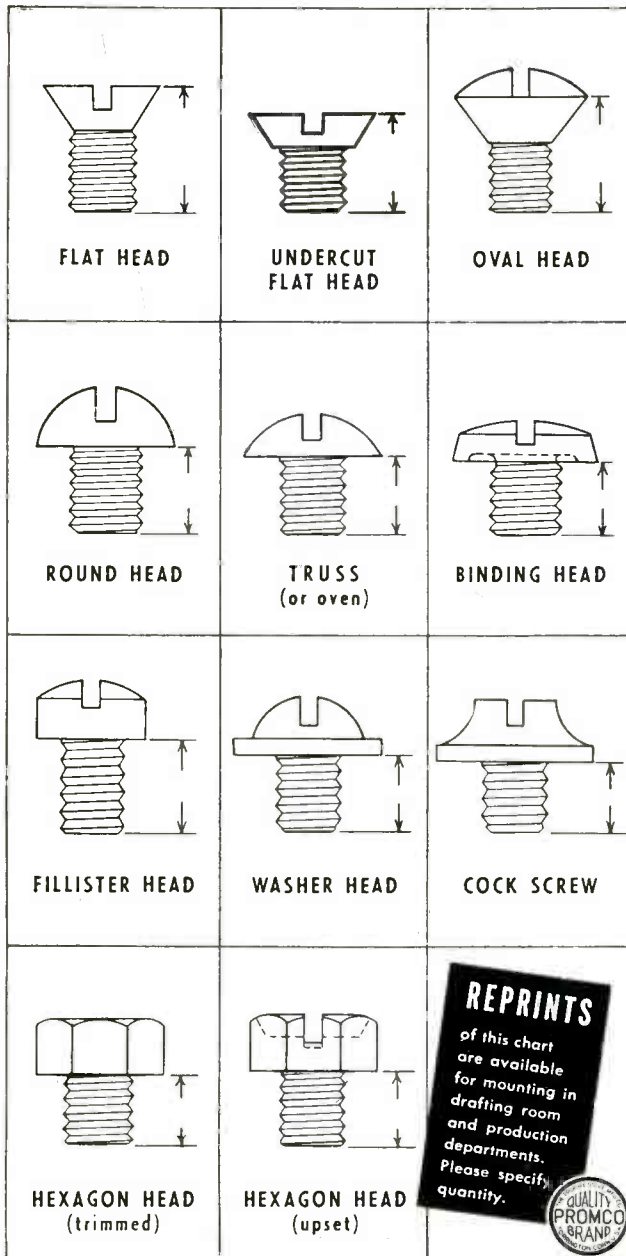

MACHINE SCREWS AND SPECIAL FASTENERS ARE OUR BUSINESS



WRITE FOR
OUR CATALOG

THE PROGRESSIVE MANUFACTURING COMPANY

50 NORWOOD ST., TORRINGTON, CONN.

ered body temperatures brought about by exposure to cold air or immersion in cold water.

Preliminary experiments indicate that r-f powers of 200 to 300 watts may be necessary for adequate human rewarming rates. Tests so far have employed from 125 to 150 watts. Because the thermal-regulating mechanism of the body assists in a return to normal body temperature, it seems likely that the higher power and a faster warming rate can be tolerated.

This information was abstracted from the Progress Report for January-March 1951 of the National Research Council of Canada, Radio and Electrical Engineering Division.

Ultrasonic Tire Testing

BY JOHN H. JUPE
Middlesex, England

AN INSTRUMENT which embodies one of the most important applications of industrial ultrasonics, namely the nondestructive testing of materials, has been put into operation for the production testing of aircraft and motor vehicle tires of all kinds. The device is used in the aircraft industry to determine whether the internal structure of aircraft tires has been damaged by the stresses brought about in landing.

The method depends on the fact that any internal discontinuity such as imperfect bonding between rubber and fabric, will necessarily lead to the presence of an air film. The air film will necessarily cause 100-percent reflection of ultrasonic waves which reach it. Such a fault makes it inadvisable to renew the treads.

The equipment to be described is used on a production basis and can detect faults which have an area of $\frac{3}{8}$ by $\frac{3}{8}$ in. or more. It consists of an ultrasonic generator, amplifiers and pneumatic handling equipment for lowering the tires into an adjacent tank of water.

A water bath is used because water produces a good transmission path between the transmitter and receiver together with reasonable acoustic matching with the rubber. There is negligible absorption or

Let **JOY** handle Your **FAN ENGINEERING** on **ELECTRONIC COOLING PROBLEMS**

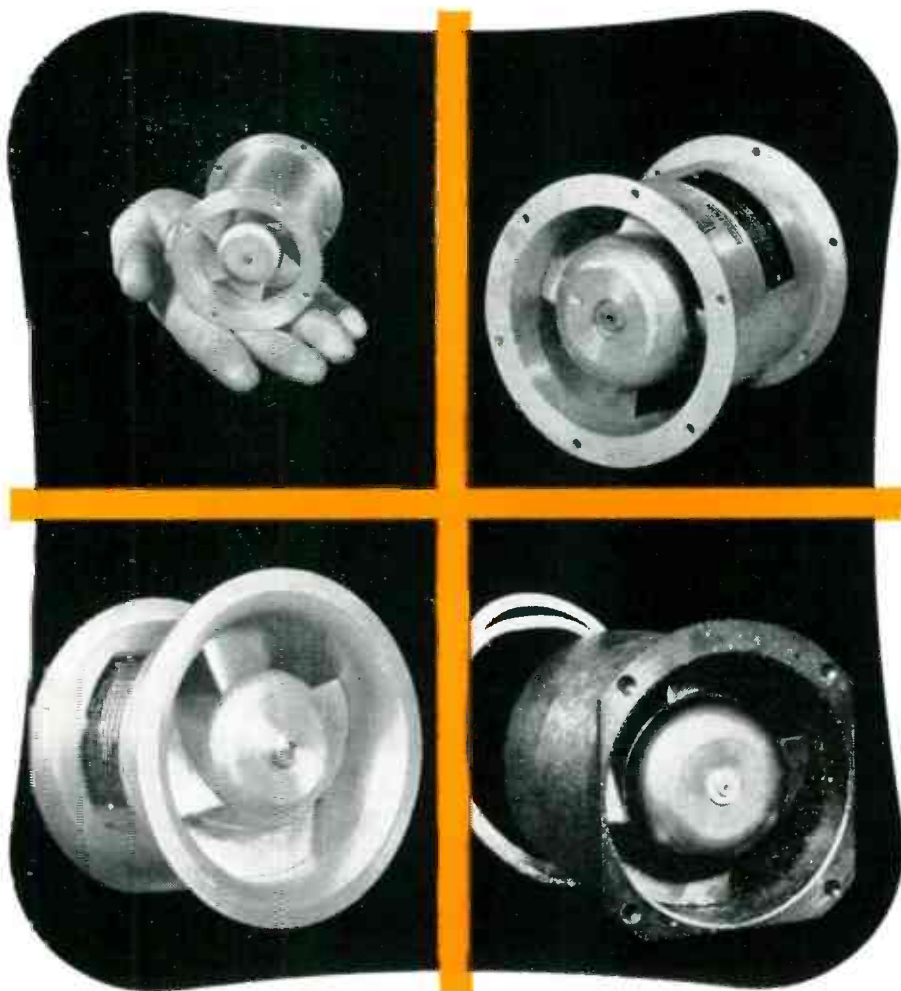

*Reg. U. S. Pat. Office

WAD 1-4010

JOY AXIVANE* Fans offer you advantages in electronic equipment cooling which have been thoroughly proved in service. The higher pressure-output of these vaneaxial blowers generally permits more compact arrangement of the equipment. Additional advantages are: light weight, high strength, high shock and vibration resistance, and high efficiency in low or high pressure service.

For minimum weight, JOY electronic cooling fans are made of aluminum, magnesium, or combinations of these metals. They are designed to meet all present Air Force and Naval electronic specifications, and are available in fan sizes from 2" I.D. up. Totally-enclosed or explosion-proof motors can be furnished where required.

• If you have a problem in heat dissipation from electronic units, no matter what the service conditions may be, let us place at your disposal JOY'S experience as the world's largest manufacturers of vaneaxial-type fans.

*Consult a Joy
Engineer*

Over 100 Years
of Engineering Leadership



JOY MANUFACTURING COMPANY

GENERAL OFFICES: HENRY W. OLIVER BUILDING • PITTSBURGH 22, PA.

IN CANADA: JOY MANUFACTURING COMPANY (CANADA) LIMITED, GALT, ONTARIO

when timing poses a problem its time to
consult the **A. W. HAYDON** company



Regardless of the intricacies of an application, you can depend on prompt and thorough evaluation by experienced engineers of The A. W. Haydon Company.

From problem statement through quantity production, the specialized know-how of The A. W. Haydon Company is devoted to expeditiously fulfilling your requirements.



The
A. W. HAYDON
COMPANY
235 NORTH ELM STREET
WATERBURY 20, CONNECTICUT
Design and Manufacture of Electrical Timing Devices

WRITE FOR
CATALOG

NEW!
MODEL 208-A
REGULATED
POWER SUPPLY



FEATURING:

- PRECISE REGULATION • HIGH STABILITY
- LOW RIPPLE • LOW OUTPUT IMPEDANCE
- 3 STAGE DC AMPLIFIER • COMPACT SIZE

OUTPUT NO. 1 0-600 VDC @ 200 MA (continuously variable). Regulation .5% from no load to full load. Hum less than 5 MV. Output impedance less than 2 ohms at 20 cycles or more. Positive or negative ground. Low voltage 6.3 VAC @ 10 amps unregulated. Metered output.

OUTPUT NO. 2 0-150 VDC @ 5 MA (continuously variable). Regulation within 1% at 150 volts. Line Input: 105-125 volts. Voltages available from front and rear. Size: Panel 8 3/4 x 19. Overall 8 3/4 x 19 x 12.

For Complete Information Write for Catalog "A"

ELECTRONIC MEASUREMENTS COMPANY • RED BANK, NEW JERSEY



NUMBERALL
CUTS THE COST OF STAMPING NUMBERS

NUMBERING MACHINES
For Stamping Metal and Plastic Products

AUTOMATIC INDENTING
NUMBERING HEAD—MODEL 50



Model 50.

Automatic indenting numbering head of consecutive or repeat numbering. 1/32" up to 3/8" high figures can be furnished in sharp face Gothic or shaded Roman figures. Can be used in foot and power presses. Numbers radio, airplane, tool parts, name plates, and other objects in brass, steel, fiber, plastics.

Heads are of sturdy construction and give uninterrupted marking service. Bulletin E50.

SELECTIVE NUMBERING HEADS
All wheels • **QUICK SET**

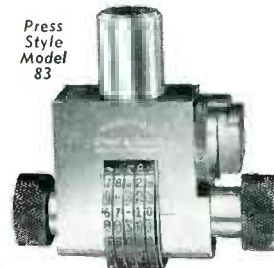

Press Style Model 83

Model 83 Heads for all stamping operations requiring quick selective numbering. Wheels engraved with direct sight figures at front of machine. Set to the required character by turning the knobs. By pushing the knobs right or

left anyone of the wheels may be engaged. Indexed wheel selector knob serves as a positive stop for every wheel. 1/16" to 1/4" size figures. Letter wheels, with up to 11 letters and a blank on each wheel can also be supplied. Heads are more efficient and durable than old style lever machines. Furnished in sizes from 1 to 15 wheels. Bulletin E83.

NEW MODEL 70
Multi-Wheel Numbering Machine
MACHINE AND SHANK ALL ONE PIECE



Model 70

The most efficient method of stamping numbers into metal. Repeats the same numbers until changed. Model 70 NUMBERALL Machines are used in all industries to mark various parts. Stamps numbers, etc., quickly . . . neatly. Perfectly aligned. Much better marks are reproduced by these machines than by single stamps or steel type, and at a far lower cost. Shank for Hand or Press and with any number of wheels from 3 to 20. Bulletin E-70.

NUMBERALL STAMP & TOOL CO.
HUGUENOT PARK STATEN ISLAND 12, N. Y.

IBM relies on MICRO Precision Switches

for vital functions in its
Type 604 Electronic Calculating Punch



Let a MICRO SWITCH Engineer
show you how you can
"use MICRO Precision Switches
as a principle of good design"

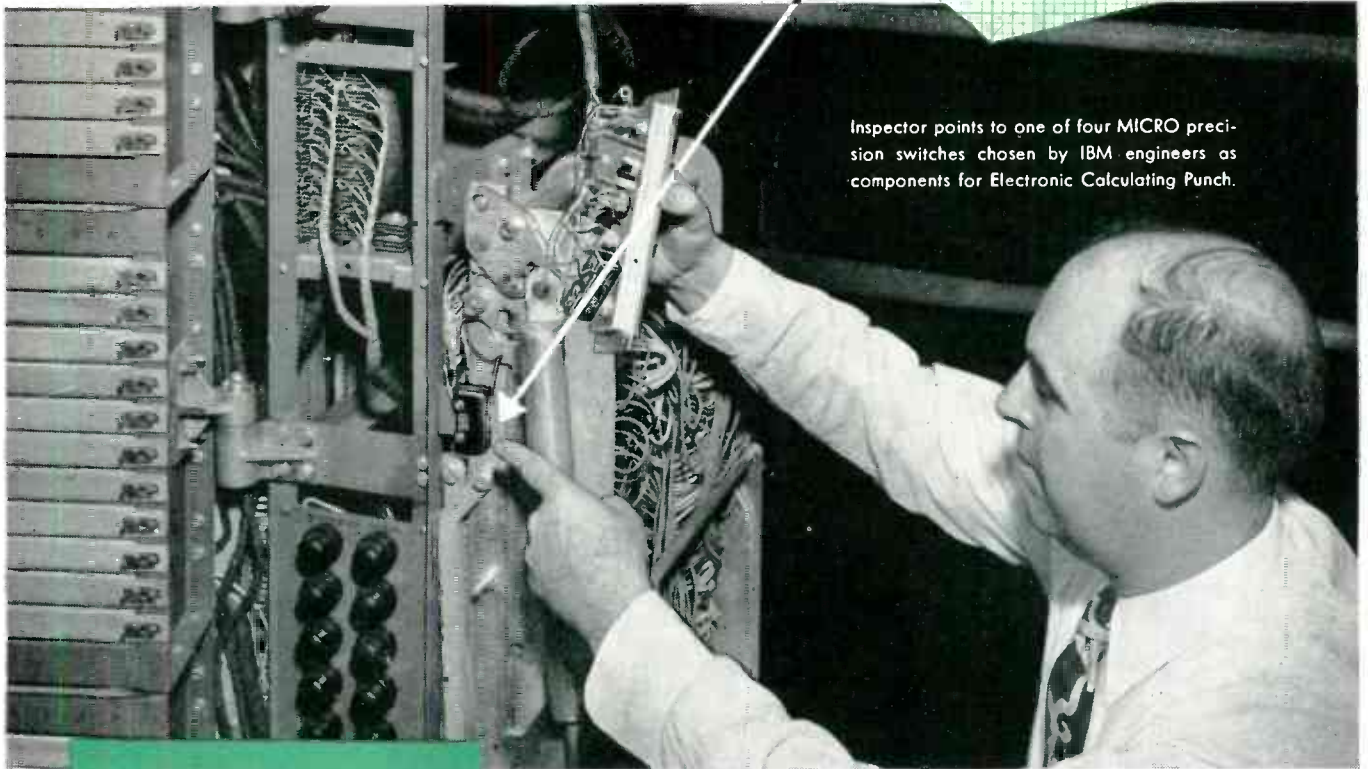

Inspector points to one of four MICRO precision switches chosen by IBM engineers as components for Electronic Calculating Punch.



The large cabinet is the all-electronic unit; the smaller is the electrical card reading and punching unit.

HUNDREDS of International Business Machines Type "604" electronic calculators... 1400 tube electronic digital computing machines... are helping solve some of the most difficult calculating problems in science, engineering, business and government.

Four MICRO precision switches were selected by IBM engineers to perform important functions in this highly complex machine which operates at the rate of 50,000 pulses per second.

These MICRO units were chosen because—(a) their positive switching action insures good electrical connection in either position instantaneously, (b)

fine adjustment minimizes travel necessary to make or break circuit, (c) ease of adaptability to the application, (d) low cost, (e) long life and dependability.

This use of MICRO SWITCH products by IBM engineers is typical of the reliance placed on these precise, accurate, snap-action switches for applications which demand only the best in all components. MICRO SWITCH field engineers, fully experienced in the requirements of electronic controls, are available to show YOU how MICRO products can help in the design and performance of your product. Call your nearest MICRO SWITCH branch.

MICRO Snap-Action Switches...
Honeywell Mercury Switches

MICRO SWITCH

FREEPORT, ILLINOIS



A DIVISION OF MINNEAPOLIS-HONEYWELL REGULATOR COMPANY

EXTRA! EXTRA! EXTRA!

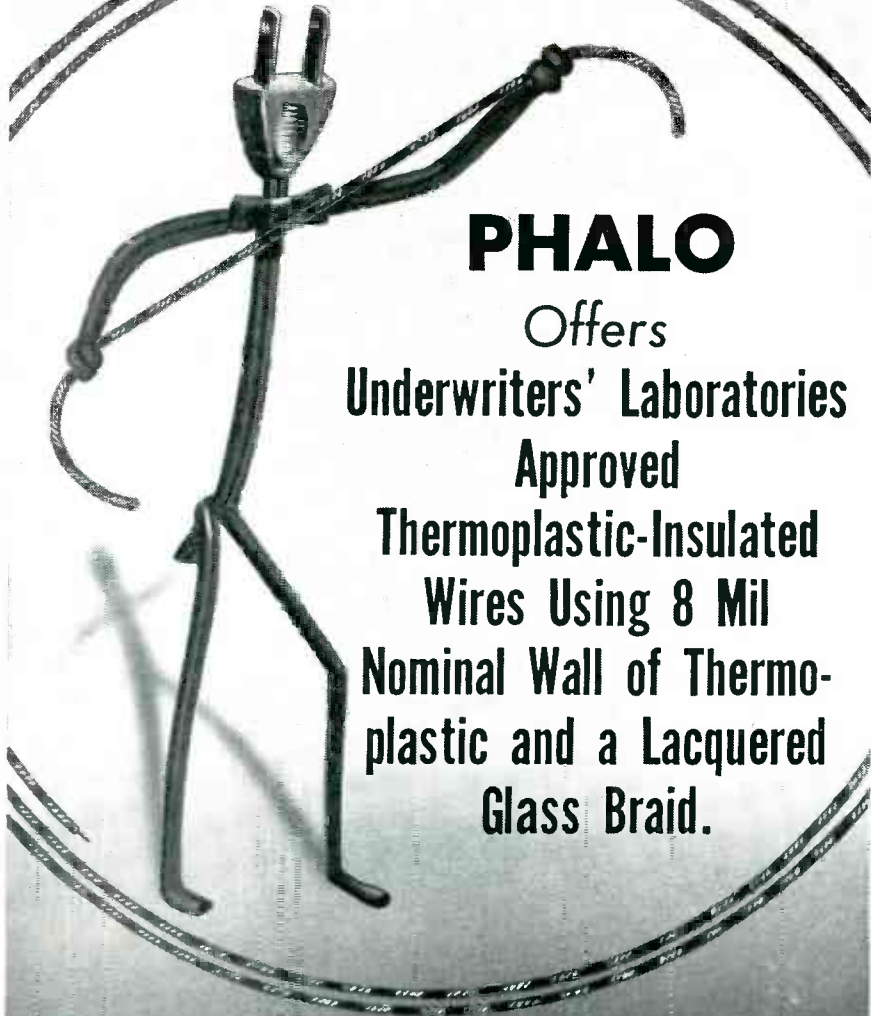

PHALO

Offers
Underwriters' Laboratories
Approved
Thermoplastic-Insulated
Wires Using 8 Mil
Nominal Wall of Thermo-
plastic and a Lacquered
Glass Braid.

For use in appliances, such as radio receiving equipment, exposed to temperatures not exceeding 105 C (or 90 C with cotton or rayon braid).

Sizes 16 to 26 AWG inclusive, any desired color.

PHALO
Plastics Corporation

Full construction and other details are yours on request.

Manufacturers of Thermoplastic Insulated Wire, Cables and Cord Sets to Commercial and Government Specifications

CORNER OF COMMERCIAL ST., WORCESTER, MASS.

reflection at the water-rubber boundary.

When the tire is lowered into the bath it rests on two rollers which are mounted in the tank above the water. The rollers can be used to revolve the tire at speeds up to 10 rpm during a test.

The ultrasonic transmitter head houses a $\frac{5}{8}$ -in. diameter quartz crystal mounted in a brass holder placed 1 in. from the rubber, in the wall of the tire, which is under water. The ultrasonic beam is radiated at an angle of 120 deg and a single transmitter within the tire can be

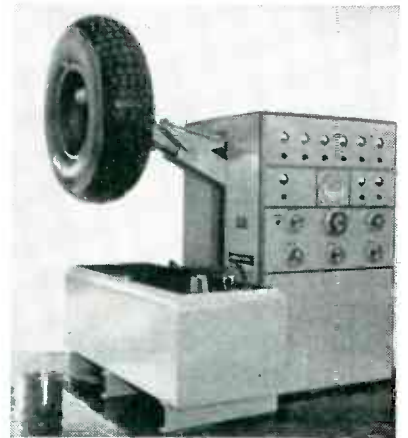

Ultrasonic tire tester showing the pneumatic loading equipment in operation

used with up to six receiving crystals spaced around the outer wall. Leads are taken from each of the crystals to separate amplifiers. Outputs from the amplifiers are used for visual indication on six meters and for the operation of six alarm circuits.

Frequency of the ultrasonic generator is 50 kc and the power output about 1 watt. Absorption of ultrasonic energy by rubber increases rapidly with frequency and therefore sets a practical industrial upper limit of about 500 kc. By using 50 kc instead of 500 kc, a wide angle of radiation is produced and a single transmitter can serve six receiving crystals.

The instrument has been put in operation by the Dunlop Rubber Co., Ltd., in Britain and was developed jointly by the Dunlop Research Center and the General Electric Company of England.

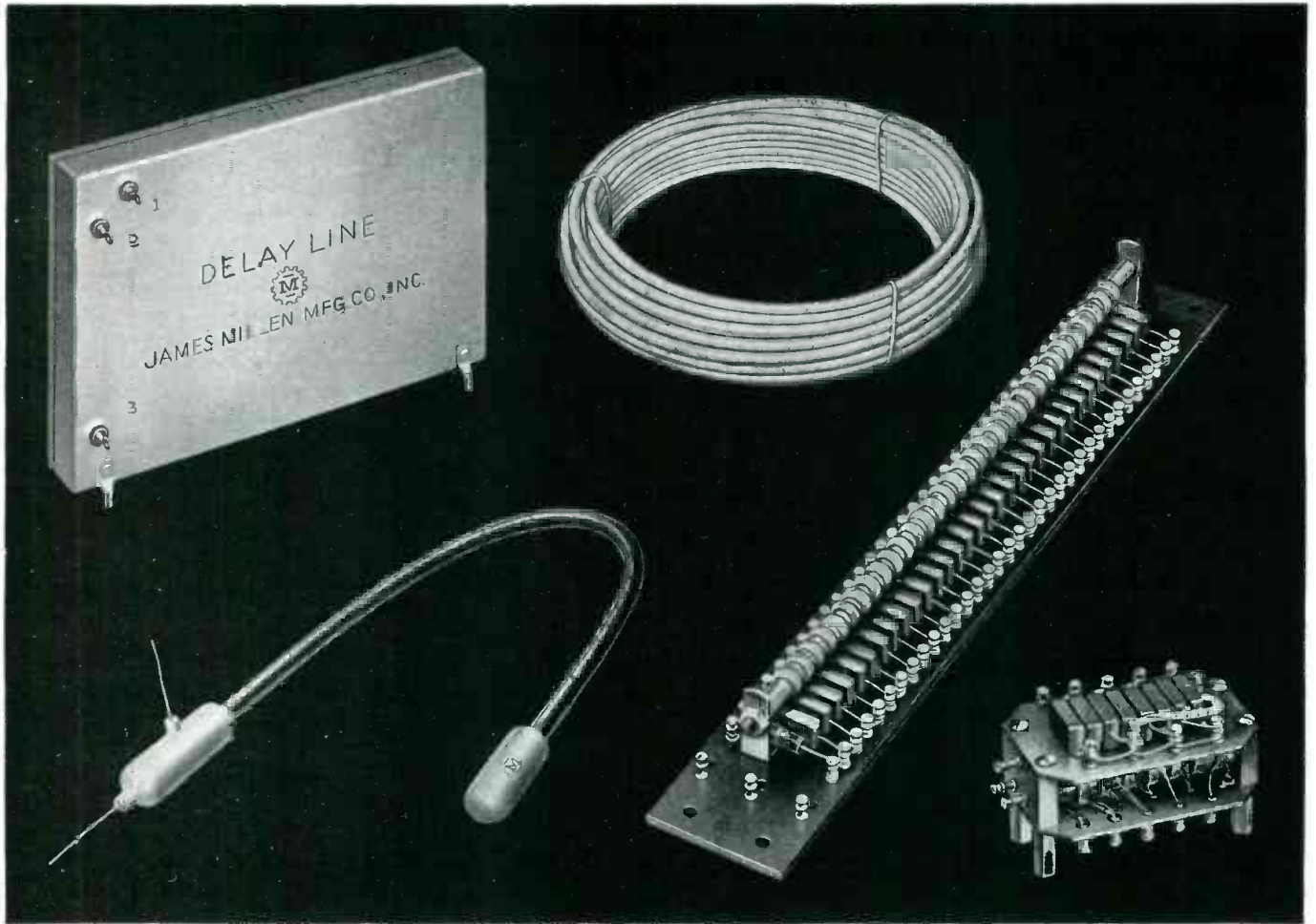

"Designed for Application"

Delay Lines and Networks

The James Millen Mfg. Co., Inc. has been producing continuous delay lines and lump constant delay networks since the origination of the demand for these components in pulse formation and other circuits requiring time delay. The most modern of these is the distributed constant delay line designed to comply with the most stringent electrical and mechanical requirements for military, commercial and laboratory equipment.

Millen distributed constant line is available as bulk line for laboratory use and in either flexible or metallic hermetically sealed units adjusted to exact time delay for use in production equipment. Lump constant delay networks may be preferred for some specialized applications and can be furnished in open or hermetically sealed construction. The above illustrates several typical lines of both types. Our engineers are available to assist you in your delay line problems.

JAMES MILLEN



MFG. CO., INC.

MAIN OFFICE

AND FACTORY

MALDEN, MASSACHUSETTS, U. S. A.

Production Techniques

Edited by JOHN MARKUS

Inexpensive Match Safes Hold Parts... 220	Cable Harness Techniques 228
Masks for Spray Painting..... 220	Detecting High-Loss Electrolytic Capacitors 224
How to Bend Tubing..... 222	Paper Containers Cut Potting Costs... 248
Plastic-Tubing Puller 222	Leak Tester 256
Dolly Rack Eliminates Cartons for Shipping Record Changers 222	Soldering Hermetic Seals..... 260
Rosin Fire Extinguisher..... 224	Special Iron Solders Tube Base Pins 264
Casting-Rod-Tips Guide Wire 224	Picture-Tube Carton 266
Anchoring Coil Leads..... 228	Miniature-Tube Inserter 268



Safety-match holders costing only 11 cents each hang on horizontal bars of racks

Inexpensive Match Safes Hold Small Parts on Benches

WHERE a large number of different kinds of small parts must be kept within easy reach of an operator, metal match safes proved more effective and far lower in cost than any other holder that could be purchased or fabricated for the purpose at DuMont's Television Transmitter Division in Clifton, N. J. The No. 320 match safe made by Continental Can Co. was obtained through the New York City office

of the firm at 11 cents each on quantity orders.

These safes normally come painted in white, with floral decals and with side cutouts to expose the striking sandpaper area of the match box. Masking tape was used to cover the openings, and some were spray-painted a uniform color. If a sufficient number are ordered at one time the manufacturer indicates willingness to modify the dies

STARTING this month, techniques for expediting the production of military and commercial electronic equipment and components will be presented to the readers of **ELECTRONICS** in this entirely new full-length department.

Here, production and methods engineers will see how problems comparable to theirs are solved in other plants.

The index at the left shows the topics covered in this first issue, starting with the jigs and fixtures of incoming inspection and going all the way down assembly lines to end up with the tricks of final packaging. Coming issues will cover still other techniques applicable to the production of electronic equipment or components, showing how to boost output, simplify an operation, improve quality or cut costs.

Contributions are welcomed, and will be paid for, with full credit to the author and his company.

so there will be no holes in the sides of the safes.

The safes are easily mounted by bending the top mounting tab over $\frac{1}{8}$ "x $\frac{1}{2}$ " strap iron bars on racks developed for holding them.

Masks for Spray-Painting

SHORT LENGTHS of spaghetti and cardboard tubing make ideal reusable masks for protecting terminals of hermetically sealed units during spray-painting. If the spaghetti sections are at least twice the terminal height, the ends can be left open without risk of getting paint in. With larger-diameter

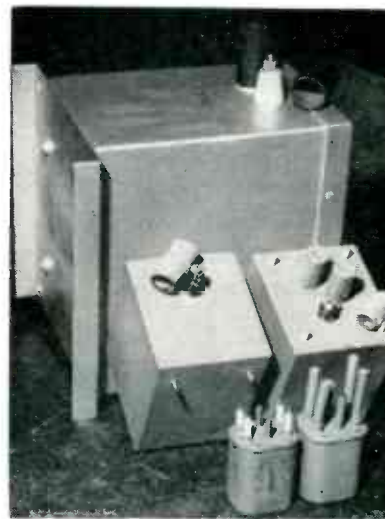

Re-usable cardboard and spaghetti masks protect terminals of hermetically sealed components during final spray-painting

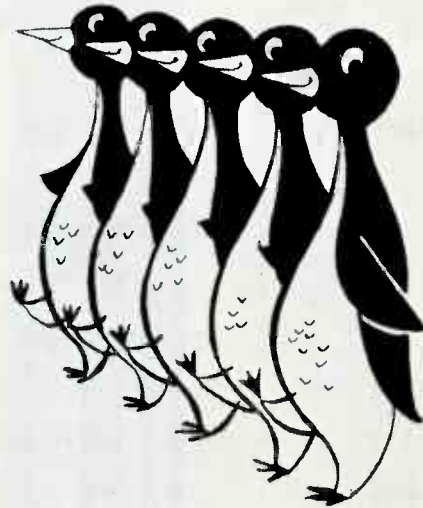

UNIFORM



KESTER FLUX-CORE SOLDER

UNIFORM In Alloy

UNIFORM In Flux Content

Right down the line, spool after spool, Kester "44" Resin, "Resin-Five" and Plastic Rosin-Core Solders offer these features of uniformity so necessary to the best in soldering.

Alloy . . . just the right amount of Tin and Lead, complying with your specifications *every time*, and only the best metals used!

Flux content . . . not a single inch of the solder is without uniform flux distribution . . . and remember, *only* Kester can give you that flexibility in core size or flux content, more or less as needed, the exact *predetermined amount*. Kester is truly an engineered Solder.

Kester meets all applicable Government Specifications.

Free Technical Manual—write for your copy of "SOLDER and Soldering Technique."

KESTER SOLDER COMPANY

4204 Wrightwood Ave., Chicago 39
Newark 5, New Jersey • Brantford, Canada

**KESTER
SOLDER**

Over 100,000 types
Kester Flux-Core Solder
Available



pieces of cardboard tubing the open end must be covered with masking tape or plugged with a cork to keep paint out. A large assortment of these tubular masks is kept on hand for immediate use at DuMont's Television Transmitter Division in Clifton, N. J.

How to Bend Tubing

SOFT copper tubing for the work coils of induction heating generators or for any other purpose can be bent easily without deformation if first pushed into a tight-fitting close-wound steel spring having about the strength of a screen-door spring, according to Wallace Barnes Co., spring manufacturers in Bristol, Conn.

Plastic-Tubing Puller

TO SPEED up the pulling of protective plastic tubing over cables comprising up to a dozen or more plain and shielded wires used in interconnecting units of television transmitters, the tubing is first placed over a quarter-inch iron rod about 15 feet long. One end of the rod is attached to the wall. At the other end of the rod, a short length of braided metal sleeving is permanently attached.

The end of the sleeving is expanded with the fingers, the cable wire ends inserted, and the sleeving is squeezed until it grips the wires firmly just as do cable grips. A few turns of electrical Scotch tape over wires and sleeving maintain the grip for the pulling operation, in which the plastic tubing is pulled easily over the wires. The new technique, used in the cable harness department at DuMont's Television Transmitter Division in Clifton, N. J., is many times faster than the former method of pushing the wires laboriously into tubing.

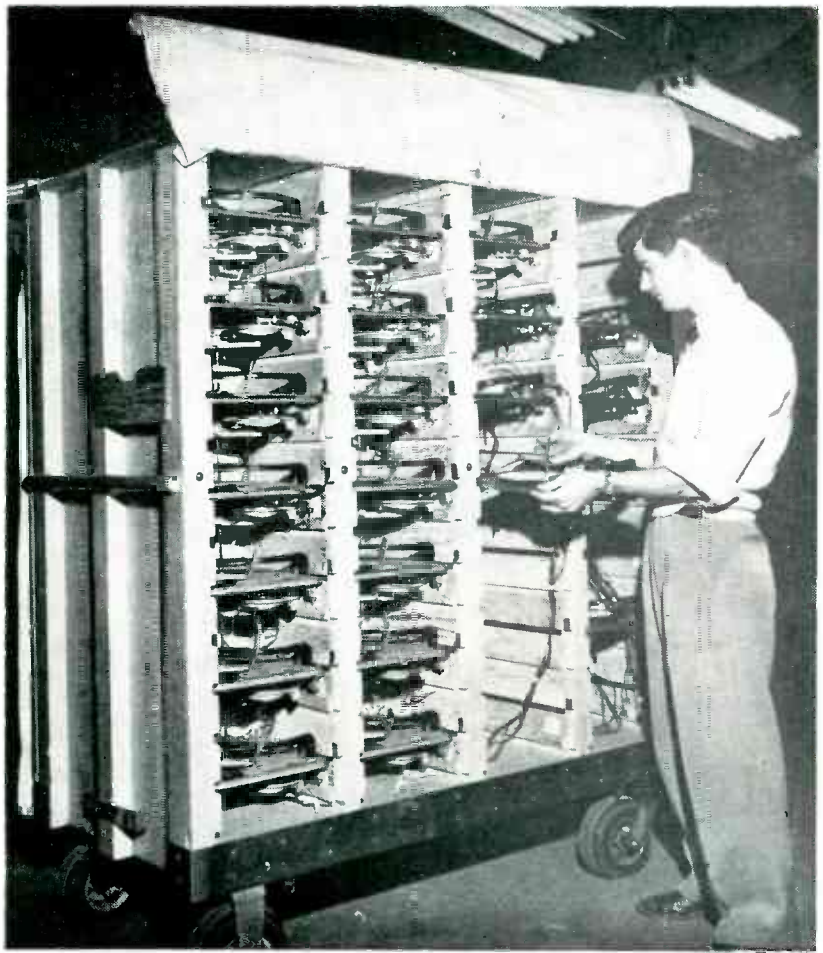

Dolly holding 28 record changers on each side is easily rolled from loading platform into trucks for delivery to receiver manufacturers, eliminating cost of cartons

Dolly Rack Eliminates Cartons for Shipping Record Changers

DOLLY-MOUNTED racks each holding 56 record changers are used by General Instrument Corp. for trucking changers from Elizabeth, N. J. to Emerson's Jersey City plant and to other locations in the New York metropolitan area. Technique saves 30 to 40-cent cost of corrugated shipping carton normally needed for individual changers, saves time of packing and unpacking cartons,

and reduces risk of damage en route.

Changers are slid into grooves in racks on each side of the cart, and heavy canvas is pulled down over sides to keep them in and keep out dust. The only packing material needed is a piece of corrugated cardboard pushed over the tone arm to keep the needle in the air; this is later needed when shipping the

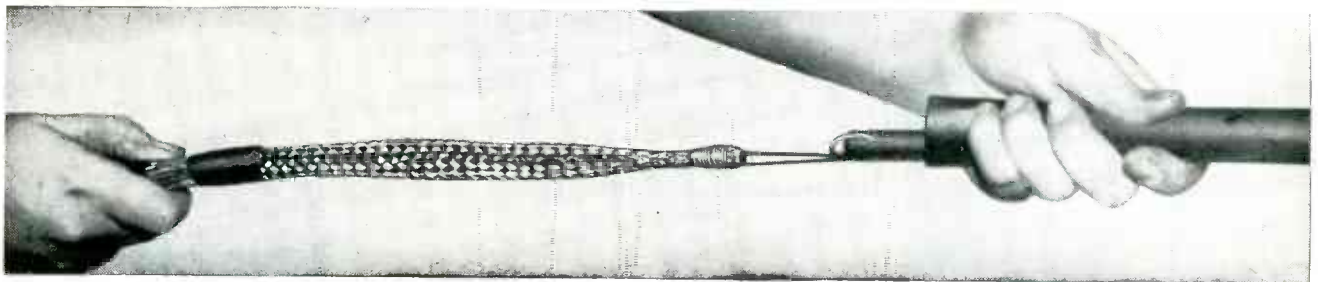

Left to right: Wires in hand ready to go into tubing; electrical Scotch tape that holds wires inside sleeving; braided metal sleeving serving as grip for cable wires; wire for attaching sleeving permanently to iron rod; plastic tubing ready to be pulled over wires



Collins 17L VHF
aircraft radio
transmitter

NOW! Full use of VHF radio by owners of executive aircraft

Civilian "non-carrier" pilots are no longer confined to VHF frequencies of 122.1-122.9 megacycles for air-to-ground radio communications. By amendment of its Rules and Regulations Governing Aeronautical Services, the FCC has enabled *all owners of aircraft regardless of type* to utilize certain frequencies within the band 118.1-126.7 megacycles.

Not only that! Under the new Controlled Materials Plan we are now authorized to use priority DO-J-6 to get materials with which to fill orders from corporation plane owners for Collins 17L transmitters.

The businessman can now equip himself to operate in the same way under instrument conditions as the scheduled airline.

The Collins 17L transmitter provides transmitting facilities on all channels reserved for aircraft

communication in the VHF band. Its frequency range is 118.0-135.9 megacycles, and all of the 180 channels assigned in this range are easily selectable over a simple and positive remote control system. The power output on voice is conservatively rated at eight watts. With this power, and the greatly increased number of frequencies now available, the pilot is assured that transmissions will be received and answered at the busiest air terminals.

The 17L is a companion to the 51R navigation receiver with which many executive planes are already equipped. The pair provides reliable two-way radio telephone communication.

We will be glad to send you a more complete description of the 17L transmitter on request.

For reliable radio communications, it's . . .



COLLINS RADIO COMPANY, Cedar Rapids, Iowa

11 W. 42nd St., NEW YORK 18

1937 Irving Blvd., DALLAS 2

2700 W. Olive Ave., BURBANK



Supplying
**TODAY'S
NEEDS**

They're "anchors to the airwaves", these JK crystals which pinpoint the RIGHT frequencies. Like much of today's fine equipment, this Collins communications receiver prefers the JK H-9.

and
**DESIGNING
TOMORROW'S**

So new their possibilities remain comparatively unexplored, JK ultrasonic transducers have become the youngest pioneers in laboratory research. They are supplied in any cut desired.



A MODERN THERMOMETER FOR OIL FIELDS

Deep in the oil fields, the JK ultrasonic transducer has found another dramatic application. It is used to measure temperatures far into the depths of the ground. When the signal changes frequency below the ground, the temperature is thus recorded. **WHATEVER** the crystal requirement, James Knights labs can furnish the crystal to do the job.

Crystals FOR THE *Critical*

Critical tolerances and precision work have put James Knights UP FRONT. Their aim: to furnish every type crystal ever made, whether out-of-date or still unheard of. To be sure, consult JK design engineers.



THE JAMES KNIGHTS CO.

SANDWICH 3, ILLINOIS

WRITE for free catalog, listing JK crystals.

completed receiver, hence is not an extra cost.

Empty dollies are taken back to the record changer plant by trucks on their return trips, for refilling.

Rosin Fire Extinguisher

WHEN rosin pots catch fire in RCA's plant, the heat melts a catch that releases a hinged metal lid, snuffing out the fire. The catch is a commercially available window-



Fire in rosin pot is snuffed out automatically by lid when heat of flame melts solder in overhead link serving as catch in Camden plant of RCA Victor

closing link whose parts are fastened together with a low-melting-point solder. When used conventionally in factory window-opening chains, heat of a fire makes the catch come apart so that windows drop automatically to cut off draft.

Casting-Rod-Tips Guide Wire

INEXPENSIVE agate-type tips for casting rods work well as guides on automatic multiple coil-winding machines at DuMont's East Paterson plant in New Jersey. The steel rod sections have adequate flexibility yet can be bent readily to required shapes. Extra springiness is obtained for guides nearest the spools of wire by using a pivot mount and a coil spring attached to

A Pen That Automatically Records Two Variables With Precision Accuracy.



You are looking at a plotting pen of one of the Model 205 Series Variplotter Plotting Boards.

With this self-balancing potentiometer type recorder, you can plot on a 30-inch square plotting surface a precise, graphic representation of one variable DC voltage as a function of a second variable DC voltage. It is also possible to plot two sets of two independent variables simultaneously, both using the full surface of the plotting board.

The Variplotter permits you to do this with speed and great accuracy — less than the width of the pen line itself. It produces a large, clear, permanent presentation that is easily interpreted.

Permit us to forward to you complete data on the new Variplotters and their accessories. We will also be very happy to study your plotting problems and make recommendations. Simply contact Electronic Associates, Inc., Long Branch, New Jersey.

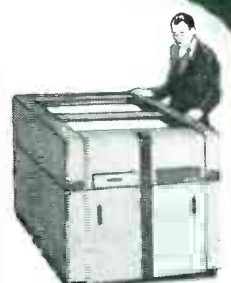

**ELECTRON C
ASSOCIATES**
Incorporated

Variplotter

Model 205 Series Plotting Boards



GET THE COMPLETE STORY ON
**SUPERIOR STEATITE AND CERAMIC
 INSULATORS FOR THE ELECTRONICS INDUSTRY.**
 SEND PRINTS FOR QUOTATIONS **TODAY.**



Custom-made to your specifications. Low-loss factor; dense, high mechanical strength. We are equipped to serve you quickly and efficiently.

SUPERIOR

STEATITE & CERAMIC CORP.

32-49 GALE AVENUE, LONG ISLAND CITY 1, N. Y.
 West Coast Representative: S. Siegel, 1145 So. La Cienega Blvd., Los Angeles 35, Calif.

IN-RES-CO
**TYPES SM-15 &
 SM-30 WIRE WOUND
 RESISTORS**

SUB-MINIATURE
weather-tested midgets

Type SM-15 and SM-30 Resistors offer three vital advantages — sub-miniature size, weather resistant construction and high resistance. The elimination of center hole mounting and the inclusion of axial leads increases winding area and results in 25% greater resistance value than resistors of standard design. Special coating is moisture and fungus proof and designed to meet JAN-R-93 specifications. Sealed in Bakelite construction affords additional climatic protection. As ratings are conservative, types SM-15 and SM-30 can be specified with confidence for service under rigorous conditions.



TYPE SM-15
 5/16" DIA. x 3/8" LG.



TYPE SM-30
 5/16" DIA. x 3/4" LG.

ASK FOR THE NEW
 RESISTOR HANDBOOK —

Contains complete data on resistors for every purpose and their recommended applications. Please make request on company letterhead.

**INSTRUMENT
 RESISTORS CO.**

COMMERCE
 AVENUE



UNION
 NEW JERSEY

APPLICATION-DESIGNED RESISTORS FOR ELECTRONICS AND INSTRUMENTATION

**2 KW
 VACUUM TUBE
 BOMBARDER
 OR
 INDUCTION
 HEATING UNIT**



For Only **\$650.**

Never before a value like this new 2-KW bench model "Bombarder" or high frequency induction heater . . . for saving time and money in surface hardening, brazing, soldering, annealing and many other heat treating operations.

Simple . . . Easy to Operate . . .
 Economical Standardization of
 Unit Makes This New Low Price
 Possible.

This compact induction heater saves space, yet performs with high efficiency. Operates from 220-volt line. Complete with foot switch and one heating coil made to customer's requirements. Send samples of work wanted. We will advise time cycle required for your particular job. Cost, complete, only \$650 Immediate delivery from stock.

Scientific Electric Electronic Heaters are made in the following ranges of Power:
 1-2-3½-5-7½-10-12½-15-18-25-40-60-80-100-250KW.

*Scientific
 Electric*

Division of

"S" CORRUGATED QUENCHED GAP CO.

107 Monroe St., Garfield, N. J.

What's inside a *Radio-Relay* station?

Because microwaves travel in straight lines and the earth is round, there are 123 stations on the transcontinental television route between Boston and Los Angeles. This view of a typical unattended station shows the arrangement of the apparatus which amplifies the signal and sends it on.

ON THE ROOF are the lens antennas, each with its horn tapering into a waveguide which leads down to equipment

ON THE TOP FLOOR, where the signal is amplified, changed to a different carrier-channel and sent back to another antenna on the roof. Here are testing and switching facilities. Normally unattended, the station is visited periodically for maintenance.

ON THE THIRD FLOOR are the plate voltage power supplies for several score electron tubes.

ON THE SECOND FLOOR are filament power supplies. Storage batteries on both floors will operate the station in an emergency for several hours, but

ON THE GROUND FLOOR is an engine-driven generator which starts on anything more than a brief power failure.

Anything that happens—even an opened door—is reported to the nearest attended station instantly.

Coast-to-coast *Radio-Relay* shows again how scientists at Bell Telephone Laboratories help your telephone service to grow steadily in value to you and to the nation.



BELL TELEPHONE LABORATORIES

Improving telephone service for America provides careers for creative men in scientific and technical fields.

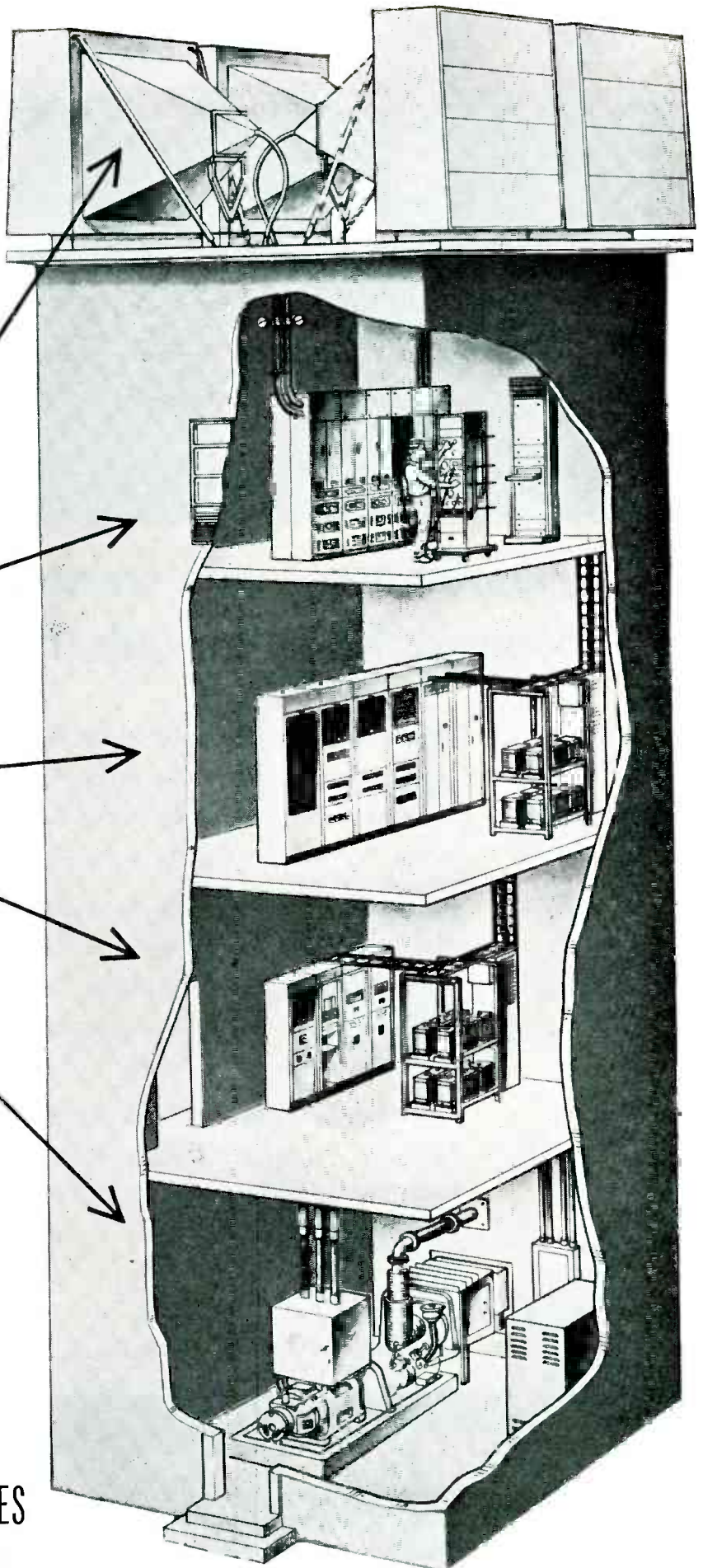



planting trees with tractors to make fibres for industry



With this MOSINEE Tree Planter, 1500 or more seedlings can be planted per hour! It completes the planting operation...even tamps the seedlings into the ground.

This is the beginning of a 30 to 40-year cycle during which seedlings grow to matured trees, ready for harvesting. They then will provide the kind of fibres needed for many products of industry.

From seedlings to technically controlled industrial paper, MOSINEE safeguards every step in the process of making
MOSINEE fibres
that work for Industry.

MOSINEE PAPER MILLS CO., Mosinee, Wis.



MOSINEE

makes fibres work for industry



Tips of casting rods serve as guides for wire on coil-winding machine

the rear end of the rod. The anchor end of the spring is adjustable in position by means of a bolt and knurled battery terminal screw, for changing wire tension.

Anchoring Coil Leads

WHEN coils are wound on thermoplastic forms, the ends of the winding are anchored simply by pressing each in turn with a wood-burning iron. This embeds the lead solidly in the plastic, since the material hardens as soon as heat is removed. The technique is now being used at Emerson's Jersey City plant for production of coils for military electronic equipment.

Cable Harness Techniques

HOLDERS for keeping wire within reach, a method of wrapping cable harness with Scotch electrical tape by hand and by machine, and a 26-roll holder for numbered labelling tape are speeding up fabrication of complicated cable harnesses at several plants.

A coil spring fastened near the bottom of a cabling board holds the ends of wires coming from spools under the board. Thus the desired color of wire is always within reach when cutting wires to length for forming on the board at DuMont's

32 Preferred Types of E-I
SEALED TERMINALS

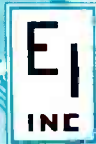

ECONOMICAL
50 SOLUTIONS
- for Hermetic Sealing
TERMINAL PROBLEMS

E-I has standardized over 50 types of sealed leads and multiple headers. These represent the most widely used types for general applications. Records extending over many years indicate they meet over 95% of all requirements.

For maximum economy and fastest possible delivery — usually from stock — engineers and designers are invited to check these standard items against their requirements.

ELECTRICAL INDUSTRIES • INC
44 SUMMER AVE., NEWARK 4, NEW JERSEY

See the Complete line
at the IRE show
BOOTH 212



18 Basic Types of E-I
MULTIPLE HEADERS

WIRE *and* CABLE

for every application

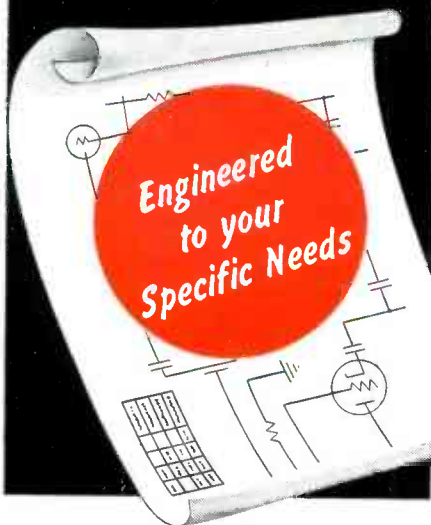

The sensitive and dependable performance so important in electronic equipment demands wire and cable that conform to rigid specifications.

You can depend on Carol wires, cables, and wiring assemblies made to your specifications to surpass every test requirement!

Carol engineering and manufacturing facilities are complete—for we draw copper, copperweld, and aluminum; formulate our insulating materials from natural rubber or synthetic rubber or plastics. Carol is a complete wire mill with all the necessary adjuncts to be completely independent and without intermediate profits.

Constant Laboratory control over raw materials, work in process, and finished product assures dependable performance.

Check the advantages of Carol quality and service in solving your wiring problems. Write us about those problems today!

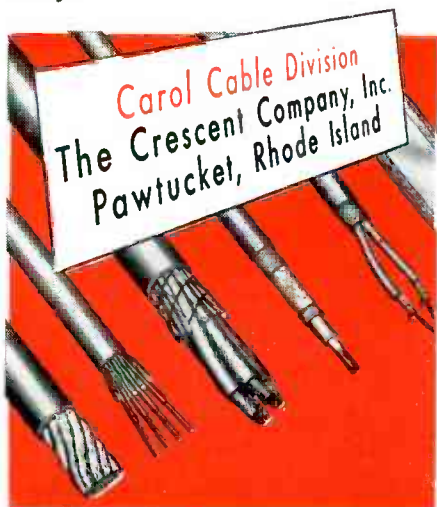

SERVOSCOPE®

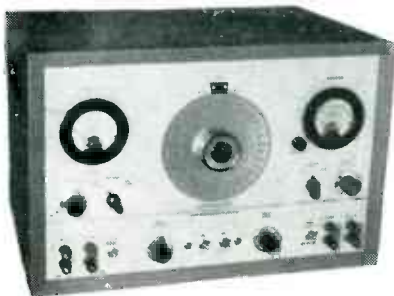

Test analyzer for use in development and PRODUCTION of SERVOMECHANISMS and PROCESS CONTROLS. Measures FREQUENCY RESPONSE, PHASE SHIFT 0.1 to 20 CYCLES SINE WAVE, SQUARE WAVE, MODULATED CARRIER, 50 to 800 CYCLES.

SERVOBOARD

A FLEXIBLE SET of PRECISION mechanical parts for quickly coupling motors, synchros, potentiometers to form assemblies of Servo systems, regulators, computers.

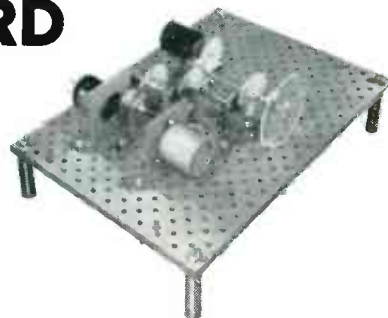

SERVO CORPORATION
OF AMERICA

DEPT. E-2

NEW HYDE PARK, N.Y.

They can take it!

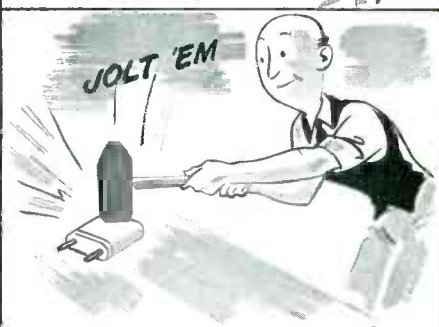

-and dish it out!

DX RADIO PRODUCTS CO.

GENERAL OFFICES: 2300 W. ARMITAGE AVE., CHICAGO 47, ILL.

Double Barrel Advertising

Advertising men agree — to do a complete advertising job you need the double effect of both Display Advertising and Direct Mail.

Display Advertising keeps your name before the public and builds prestige.

Direct Mail supplements your display advertising. It pin-points your message right to the executive you want to reach — the person who buys or influences the purchases.

More and more companies are constantly increasing their use of Direct Mail because

it does a job that no other form of advertising will do.

McGraw-Hill has a special Direct Mail Service that permits the use of McGraw-Hill lists for mailings. Our names give complete coverage in all the industries served by McGraw-Hill publications — gives your message the undivided personal attention of the topnotch executives in the industrial firms. They put you in direct touch with the men who make policy decisions.

Some people have a wrong conception of Direct Mail. There's no hocus-pocus to it — there's no secret formula — nor is there need for an extensive department to plan and execute your mailing program. You don't even need your own mailing lists.

Probably no other organization is as well equipped as McGraw-Hill to solve the complicated problem of list maintenance in industrial personnel. Our lists are compiled from exclusive sources, based on hundreds of thousands of mail questionnaires and the reports of a nationwide field staff, and are maintained on a twenty-four hour basis.

In view of present day difficulties in maintaining your own mailing lists, this efficient personalized service is particularly important in securing the comprehensive market coverage you need and want:

Ask for more detailed information today. You'll be surprised at the low over-all cost and the tested effectiveness of these hand-picked selections.

for Results



Mc GRAW-HILL
DIRECT MAIL LIST SERVICE

McGRAW-HILL
PUBLISHING COMPANY, INC.

330 WEST 42nd STREET, NEW YORK 18, N. Y.



RCA-5563. Peak cathode current of 70 CA max. for peak inverse voltage of 10 KV.

... your choice, up to 15,000 volts!*

RCA is headquarters for a wide line of thyratrons—gas types and mercury-vapor types, triodes and tetrodes, miniatures and jumbo sizes. Peak cathode current ratings range from 0.1 to 77 amperes, maximum. Anode voltage ratings range from 350 to 15,000 volts, maximum peak inverse!



For prompt, on-the-spot service, call your local RCA Tube Distributor. He can supply you with RCA thyratrons—and all types of RCA tubes for industrial applications.

*Maximum peak inverse rating



RADIO CORPORATION of AMERICA
ELECTRON TUBES
HARRISON, N. J.



How pre-stretched coil springs are used for holding wire ends on cable harness board at DuMont plant

Television Transmitter Division in Clifton, N. J. The spring is bolted to a metal mounting strap so that the turns are pre-stretched to the desired spacing. Fastening the strap rather than the spring to the board permits moving the spring around on the board as often as desired without changing the spacing between turns. Mounted springs with various lengths and spacings are kept on hand for use when setting up cable boards, to hold the ends of already-cut cable wires on the cable board as well.

Scotch electrical tape is used in place of conventional waxed lacing

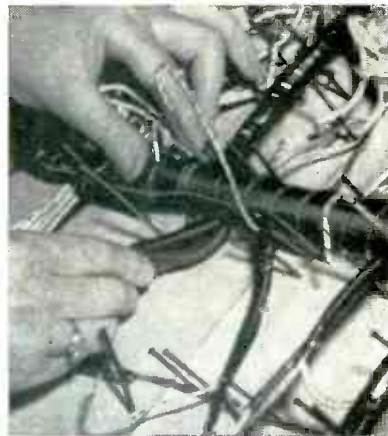

Pulling flat wad of Scotch electrical tape under harness during taping operation that replaces lacing at DuMont plant

Only

ELECTRO TEC
PRECISION-MINIATURE
slip ring assemblies
AND COMMUTATORS
offer all these advantages.

EXCLUSIVE* ELECTRO TEC TECHNIQUES

*insure closer tolerances, absolute uniformity,
and the ultimate in miniaturization*

Electro Tec units are the product of an exclusive manufacturing technique that results in accuracy unattainable by conventional fabricating methods. In this process a plastic is moulded around the wire leads. Accurate machining reduces this blank to the proper shape, complete with grooves. Hard silver is deposited into the grooves by electroplating to produce the required rings. Final machining insures concentricity and dimensional accuracy. The result is one-piece, unitized construction with conducting rings of 60 to 70 Brinell hardness.

Diameters of these assemblies range from .045" to 24" cylindrical or flat. Cross-sections may range from .005" to .060" or more. Rings are polished to a jewel-like finish and can be held to 4 micro-inches or better. Even the smallest sizes withstand a 1000 V.A.C. breakdown test. Most types easily withstand rotational speeds up to 12000 rpm.

**ELECTRO TEC Assemblies are Specified by the Nation's
Leading Precision Instrument and Equipment Manufacturers for Proven
Greater Dependability, Longer Life, Smoother Functioning.**

The uniformly superior performance of Electro Tec slip ring and commutator assemblies in thousands of industrial and governmental applications has resulted in wide adoption of these component units by most leading manufacturers of precision instruments and equipment. Although these products provide improved performance and extra dependability, prices are strictly competitive. Write today for fully illustrated literature.

ELECTRO TEC CORPORATION
SO. HACKENSACK NEW JERSEY

PRODUCTS OF PRECISION CRAFTSMANSHIP BY A NEW AND REVOLUTIONARY PROCESS

- ONE PIECE, UNITIZED CONSTRUCTION
- ABSOLUTE MINIMUM TORQUE FRICTION
- DIAMETERS FROM .045" TO 24.0"
- MINIMUM 1000 V.A.C. HI-POT INTER-CIRCUIT
- UNIFORMLY HARD SILVER RINGS PLATED INTO GROOVES ON PRECISION MACHINED ONE PIECE PLASTIC FORM
- SPECIAL SURFACE DEPOSITS PREVENT TARNISH, MINIMIZE FRICTION, BRUSH NOISE AND PRACTICALLY ELIMINATE WEAR

ACTUAL SIZE

ULTRA-MINIATURIZED SLIP RING ASSEMBLY

- 6 Insulated Contact Rings
- Ring Width .030"
- Barrier Width .015"
- Ring Diameter .045"
- Weight 5.5 Grains (1/80 Ounce)
- Rings 60-70 Brinell
- Fine Silver
- Tarnish Resistant, Friction Minimizing Surface Deposits
- 1000 Volt Hi-Pot Between Rings
- Color Coded Leads

*PATENTS PENDING

For ultra
precision
design



specify **Micro**,
America's only
fully ground
miniature
ball bearings



In just three years, sales of Micro bearings have soared 850% as more and more top-flight designers and engineers choose Micro for exacting designs. Only grinding can give you the ultra precision and trueness of dimension Micro offers — yet Micro bearings actually cost less than unground miniatures. 85 sizes and types in dimensions as small as $\frac{1}{8}$ " o.d. and in tolerance ranges of ABEC-5 and above.

Write for Technical Bulletin No. 50

MICRO

New Hampshire

Ball Bearings, Inc.

5 MAIN STREET, PETERBOROUGH 1, N. H.



**SPECIALTY
OFFERS**

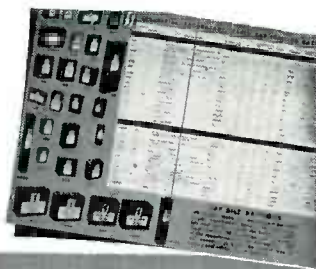

LAB-BILT DRY BATTERIES
Standard or Custom-made



INDUSTRY

LABORATORY



RADIO AND
IGNITION



Write for **FREE CATALOG**

This catalog gives complete specifications of 78 Lab-Bilt Batteries of industrial and hard-to-get types.

CUSTOM-MADE BATTERIES

Battery Specification Sheet illustrated in catalog enables you to get any type dry battery designed and made to your individual specifications — even in small quantities!

SUPER SERVICE

Specialty Battery Company is specially equipped to make all Lab-Bilt Batteries FRESH for each order and ship immediately. Give your customers this valuable service. Write for a new catalog today.

SPECIALTY BATTERY COMPANY

A Subsidiary of the **RAY-O-VAC** Ray-O-Vac Company

MADISON 10, WISCONSIN

The Nonmelting Silicone Insulating
and Waterproofing Compound that
is stable from -70° to over 400° F.

Meets all
Requirements
of AN-C-128a

DOW CORNING
4 COMPOUND



Dow Corning 4 applied by brushing to AN connector receptacle of pilot's "jack box" prevents interference caused by moisture at this critical junction in aircraft communications system.



Dow Corning 4 applied by brushing to AN connector on V. H. F. Transmitter/Receiver excludes moisture without appreciable change in resistance across properly mated pin and socket connections.



Arrows show where Dow Corning 4 is used on variable inductance rollers in a Collins-Western Electric V. H. F. Transmitter/Receiver to lubricate, minimize resistance and reduce leakage losses.

Photos courtesy Braniff International Airways.

More water repellent than paraffin, Dow Corning 4 Silicone Compound is highly resistant to oxygen, ozone and deterioration caused by corona discharge.

Write Today! for your copy of our new booklet on Dow Corning 4 Compound. Address Department BD.



MIDLAND, MICHIGAN

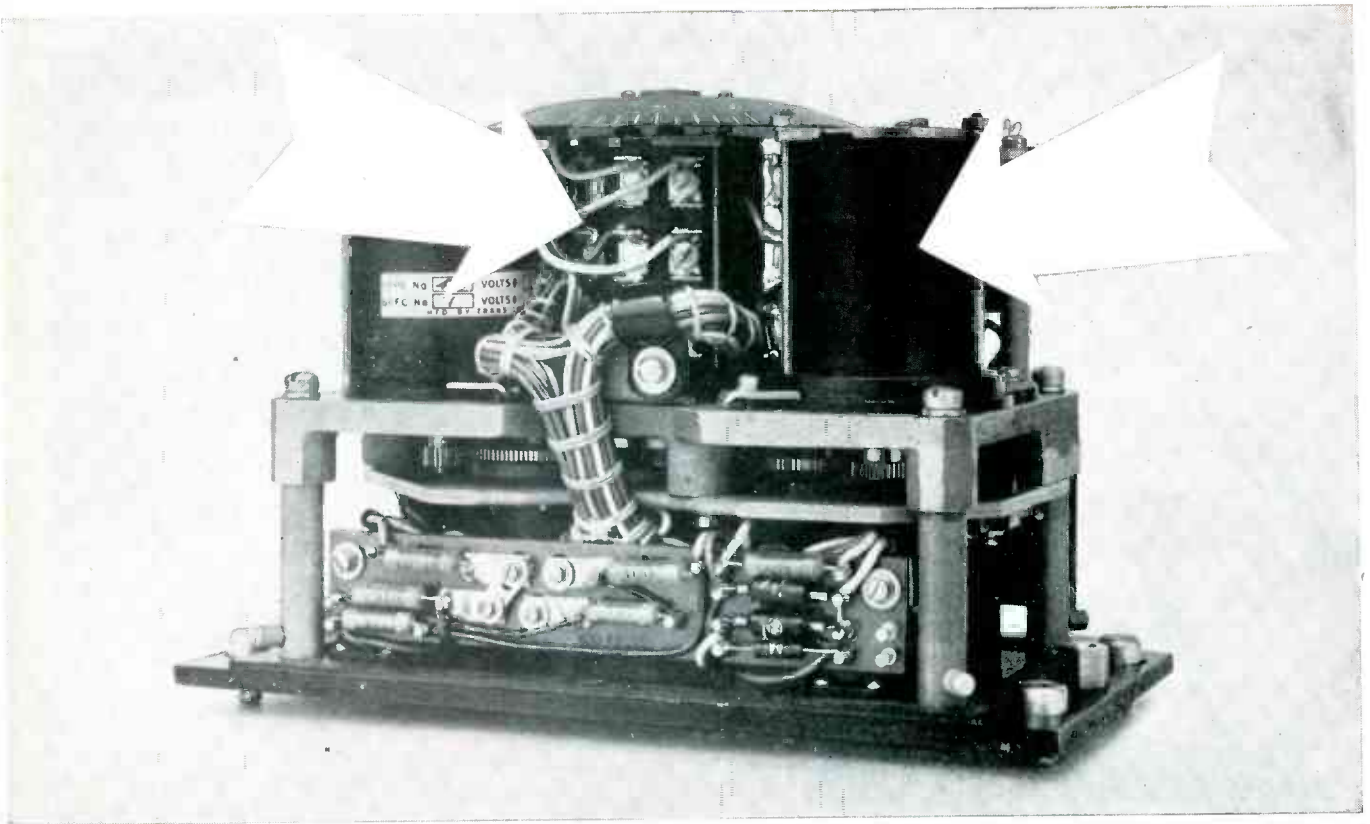

Potentiometer precision—where it counts!

Engineers at Servomechanisms, Inc., needed control components that would go hand-in-hand with the extremely high accuracy they designed into this computer for a radar-gunfire control system. Two 3-gang Fairchild precision potentiometers are used for two principal reasons—

1. they have extremely high functional accuracy, and
2. their precision mechanical design eliminates backlash and binding which would cause serious errors in the computing system.

These potentiometers are driven through 72-pitch stainless-steel gears. Fairchild potentiometers depend on more than just accurate windings for precision. For details see below.

HOW PRECISION IS BUILT INTO FAIRCHILD POTENTIOMETERS

1. The *shaft* is centerless-ground from stainless steel to a tolerance of $+0.0000$, -0.0002 in. which together with precision-bored bearings results in radial shaft play of less than 0.0009 in.
2. The *mounting plate* has all critical surfaces accurately machined at one setting to insure shaft-to-mounting squareness of 0.001 in./in. and concentricity of shaft to pilot bushing within 0.001 in. FIR.



3. The *housing* is precision-machined from aluminum bar stock. Close tolerance of this construction permits ganging up to 20 units on a single shaft without eccentricity of the center cup, even though only two bearings are used for the entire gang.

4. The *windings* are custom-made by an exclusive technique. Guaranteed accuracy of linear windings in the types illustrated is 0.5%; non-linear 1.0%. Higher accuracies (to 0.05%) are available in other types. Guaranteed service life is 1,000,000 cycles.

DO YOU NEED THIS KIND OF PRECISION? Fairchild Sample Laboratory engineers are available to help on special potentiometer problems. To get the benefit of their knowledge and experience write today, giving complete details, to Fairchild Camera and Instrument Corporation, 88-06 Van Wyck Boulevard, Jamaica 1, New York, Department 140-24A.

Visit our exhibit at Booth 238-239 at the I.R.E. show

ELECTRONICS — February, 1952

FAIRCHILD
PRECISION POTENTIOMETERS

Leach RELAYS

✓ TROUBLE-FREE PERFORMANCE

"as specified"

Because all *Leach Relays* are *quality engineered* for dependable duty... they are specified *first* by leading manufacturers of industrial equipment of all types. If your equipment demands relays that are first and foremost, more dependable and longer lasting, specify *Leach Relays*... they're more dependable... *performance proves it*. Whatever your relay control problem... it's a challenge to *Leach*. Illustrated are but a few of the wide selection *Leach* provides industry, as standard equipment.

RELAYS SHOWN ABOVE CAN BE SUPPLIED WITH VARIOUS CONTACT ARRANGEMENTS. WRITE FOR DETAILS.
BETTER CONTROLS THROUGH BETTER RELAYS



✓ MOTOR STARTING RELAY



✓ OVERLOAD TRIP LIGHT DUTY



✓ HERMETICALLY SEALED



✓ MIDGET LATCHING RELAY



✓ RADIO AND HIGH VOLTAGE



✓ ANTENNA TRANSFER



✓ MULTIPOLE RELAY



✓ MIDGET RELAY



✓ CIRCUIT CONTROL



Rewinding tape into flat wad that is easily shoved under cable. Completed wad is at upper right on steel table, with fishpaper core under it

cord at Dumont's Television Transmitter Division. The formed cable cannot be lifted off the pegs on the board until completely taped, hence standard rolls of tape are too big to be pushed under the cable. The tape is therefore rewound into flat needle-like packets that slip under the cable easily. A piece of fishpaper is folded over a metal strip welded to a flat metal plate, and the tape is rewound onto the fishpaper. Straight runs of cable are left untaped on the board, and taped later at high speed in a Segur taping machine adapted for use of No. 22 Scotch electrical tape. A completely taped cable harness holds its shape much better at sharp bends and corners than a laced cable.

Application of numbered pieces of Scotch tape to wire ends of tele-



Winding Scotch electrical tape on formed cable harness with modified Segur taping machine

LEACH RELAY CO.

5915 AVALON BOULEVARD, LOS ANGELES 3, CALIFORNIA
 Representatives in Principal Cities of U. S. and Canada

*It helps
Gunners
to "Bear On
Target"*

Added Evidence
that _____

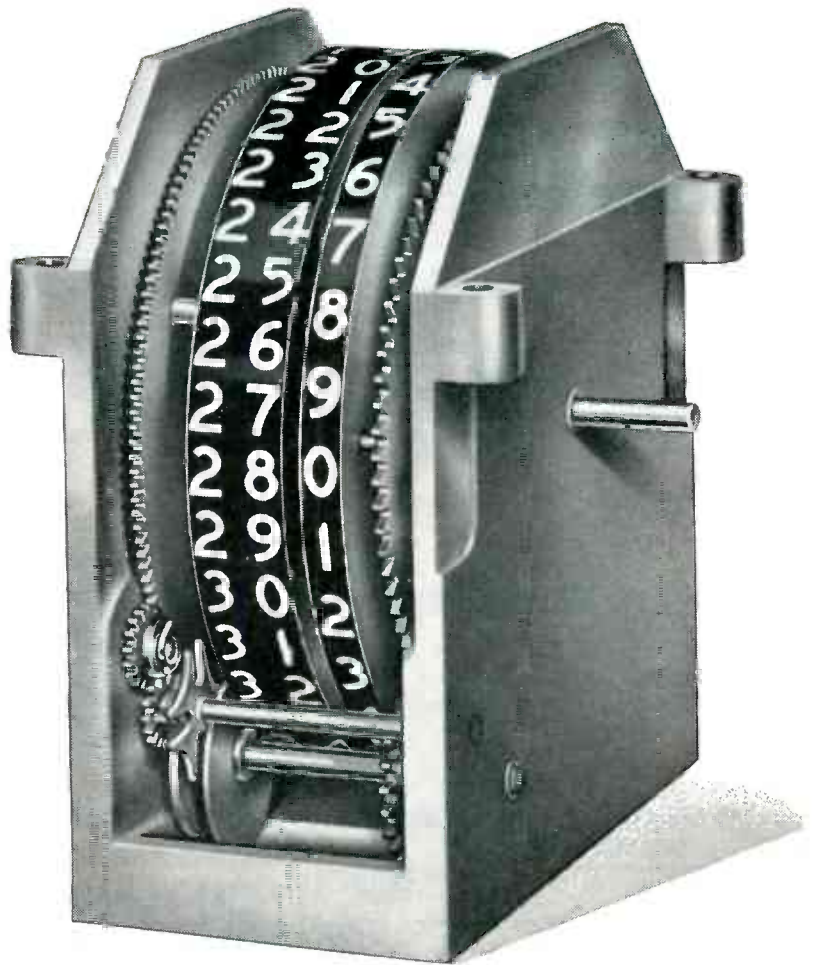

Everyone Can Count on VEEDER-ROOT



This is a 360-degree bearing counter... equipped with high-speed Geneva transfer and large, readily readable figures... which speeds the work and heightens the accuracy of gunnery. And it might well be adapted to bring the same advantages to many other operations in defense work.

Now if your imagination is stirred by this suggestion, then you can count on Veeder-Root to help you add up to something that will really count to *YOUR* advantage.

VEEDER-ROOT INCORPORATED
"The Name That Counts"
HARTFORD, CONN. • CHICAGO • GREENVILLE, S. C.
Montreal, Canada • Dundee, Scotland
Offices and agents in principal cities



"Counts Everything on Earth"

The new S.S. WHITE 80X HIGH VOLTAGE RESISTOR

(1/2 Actual Size)
4 watts • 100 to 100,000 megohms

Developed for use as potential dividers in high voltage electrostatic generators, S.S. White 80X Resistors have many characteristics—particularly negative temperature and voltage coefficients—which make them suitable for other high voltage applications.

They are constructed of a mixture of conducting material and

binder made by a process which assures adequate mechanical strength and durability. This material is non-hygroscopic and, therefore, moisture - resistant. The resistors are also coated with General Electric Dri-film which further protects them against humidity and also stabilizes the resistors.

WRITE FOR BULLETIN 4906

It gives complete information on S.S. White resistors. A free copy and price list will be sent on request.



THE S.S. White INDUSTRIAL DIVISION
DENTAL MFG. CO.



Dept. R, 10 East 40th St.
NEW YORK 16, N. Y.

WESTERN DISTRICT OFFICE: Times Building, Long Beach, Calif.



PRECISION-MADE PORCELAINS for Electronic Applications

The high quality porcelain insulators you need are assured by Louthan's careful workmanship and close inspection. Louthan specializes in Vitrified, Refractory, and low-loss Steatite porcelain insulating parts, with the clean, smooth surfaces, the good mechanical strength,

the specified electrical properties, and the dimensional accuracy your applications demand.

Louthan production facilities are geared for volume production and prompt deliveries. Send us your inquiries today.

EXCLUSIVE REPRESENTATIVES:

H. B. ZEIGER, New York 17, N. Y. • GLENN GARNER CO., Chicago 6, Ill. • WM. F. HOEFER, Pasadena, Calif.

THE LOUTHAN MANUFACTURING COMPANY

A Subsidiary of Harbison-Walker Refractories Co.

EAST LIVERPOOL, OHIO

THE SAR PULSESCOPE

BY WATERMAN

MODEL
S-4-A



Weight 31.5 lbs.

9 1/8" x 11 1/4"
x 17 1/4"

Another example of WATERMAN pioneering, a compact, portable instrument for precision pulse measurements adaptable for all electronic work, including radar and TV. S-4-A SAR PULSESCOPE will portray all attributes of the pulse; such as shape, amplitude, duration and time displacement. In S mode of operation, the unit functions as a wide band oscilloscope, with optional video delay, in either repetitive or triggered sweep conditions. In A mode of operation the unit functions as a precision time measuring device, with internal crystal controlled markers available for self calibration. In R mode of operation a desired small segment of A Sweep is expanded to fill the face of the tube for detailed observation.

Video Amplifier band pass up to 11 mc... optional Video delay 0.55 μ s... Pulse rise and fall time better than 0.07 μ s... Video sensitivity of 0.5 p to p/inch... S Sweep 80 cycles to 400 KC either triggered or repetitive... A Sweep 1.2 μ s to 12,000 μ s, R Delay 3 μ s to 10,000 μ s... Directly calibrated on a precision dial... R Pedestal (or sweep) 2.4 μ s to 24 μ s... A & R Sweep Triggers available externally... Internal crystal markers of 10 μ s \pm 50 μ s... Built in precision amplitude calibration... Operates on 50 to 1000 cycles at 115V AC.

WATERMAN PRODUCTS CO., INC.

PHILADELPHIA 25, PA.
CABLE ADDRESS: POKETSCOPE

WATERMAN PRODUCTS INCLUDE:

S-5-A LAB	PULSESCOPE
S-10-B GENERAL	POCKETSCOPE
S-11-A INDUSTRIAL	POCKETSCOPE
S-14-A HIGH GAIN	POCKETSCOPE
S-14-B WIDE BAND	POCKETSCOPE
S-15-A TWIN TUBE	POCKETSCOPE

Also RAYONIC Cathode Ray Tubes
RAKSCOPES and other equipment



PRACTICALLY PURE DIRECT CURRENT—Less than 1/4 of 1% Ripple

Bogue Low Ripple DC Generators

for:

- 1. High Power Electronic Equipment**
- 2. Testing of High or Low Power Electronic Equipment**
- 3. Telephone Exchange Battery Charging**
- 4. Cyclotron Power and similar applications**

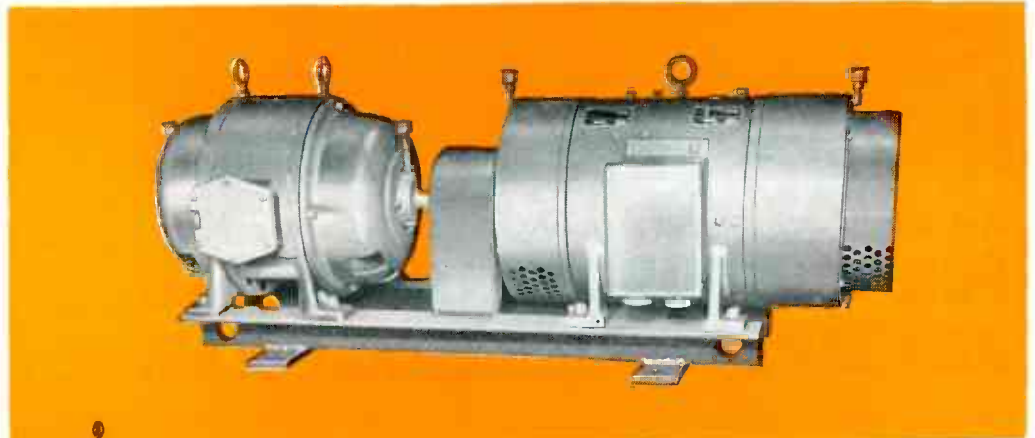

Bogue
25KW, 1000 Volt
Control Panel

Bogue Electric produces a line of AC/DC Motor-Generator Sets whose DC output contains less than 1/4 of 1% ripple, with some designs as low as 1/10 of 1%. This excellent performance is secured by precision design, care in selection of materials, and quality control in manufacture.

The units are made in sizes from 1KW to 25KW and in voltages from 6 to 1000 or higher if required. If extreme accuracy in output voltage is required the sets can be equipped with Bogue Magnetic Amplifier (Static) Voltage Regulators which will hold the DC output voltage constant to within 1/10 of 1% over the full range from no load to full load. If you have problems along these lines please consult our engineering department.

BOGUE ELECTRIC MANUFACTURING COMPANY

Where Precision Coordinated Design... Counts!

50 IOWA AVENUE

PATERSON 3, NEW JERSEY

MAGNETIC AMPLIFIERS • MAGNETIC CONTROLLERS • AC & DC MOTORS
AC & DC GENERATORS • VOLTAGE & SPEED REGULATORS • SWITCHBOARDS



BOGUE PRECISION POWER



Ask one of our 3M Service Engineers

FOR A "SOUND SOLUTION" TO ANY TAPE RECORDING PROBLEM

Eighty 3M engineers in the field—backed by twenty technical experts in the 3M laboratories—stand ready to help you with any tape recording problem.

This 3M Service Organization works daily with radio station engineers, electronic engineers and industries using tape recordings in process or quality control. The same electronic and engineering know-how that produced and perfected the famous "SCOTCH" Sound Recording Tape offers you technical assistance on every phase of sound recording.

If you are using sound recording equipment in your radio station, laboratory or business, call upon the 3M Service Representative in your community. He'll be glad to help you make better recordings—more easily. If you are contemplating the use of tape recordings, he'll be glad to analyze your requirements and aid in the selection of equipment.

Call him today—or, if you prefer, write directly to Minnesota Mining & Mfg. Co., Dept. E-22, St. Paul 6, Minn. No obligation, of course.

Here's why more recording engineers use "SCOTCH" Sound Recording Tape than all other brands combined:

- **REEL TO REEL UNIFORMITY**—controlled coating assures consistent output.
- **THINNER CONSTRUCTION**—resists temperature and humidity changes.
- **NO CURLING OR CUPPING**—tape lies flat on recording head unaffected by humidity.
- **UNIFORM TAPE SURFACE**—no "drop-outs" on recordings due to surface irregularities.
- **LONGER TAPE LIFE**—special lubricating process reduces friction.
- **GREATER SENSITIVITY**—more output on your present machine setting.



The term "SCOTCH" and the plaid design are registered trade-marks for Sound Recording Tape made in U.S.A. by MINNESOTA MINING & MFG. CO., St. Paul 6, Minn.—also makers of "Scotch" Brand Pressure-sensitive Tapes, "Underseal" Rubberized Coating, "Scotchlite" Reflective Sheeting, "Safety-Walk" Non-slip Surfacing, "3M" Abrasives, "3M" Adhesives. General Export: Minn. Mining & Mfg. Co., International Division, 270 Park Avenue, New York 17, N.Y. In Canada: Minn. Mining & Mfg. of Canada, Ltd., London, Canada.

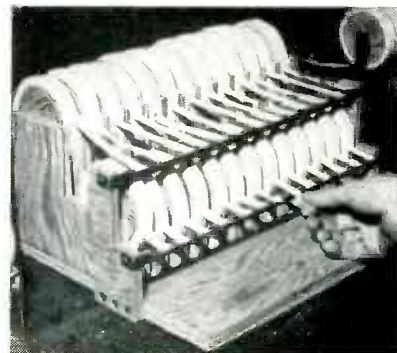

Dispenser holding 26 different numbered rolls of plastic adhesive tape. All plywood is $\frac{1}{2}$ inch thick. Partitioning supports for rolls are all identical here, but outer two may be modified to serve as supports for serrated tear-off strips, instead of using separate plywood supports

vision transmitter cable harness was speeded up at DuMont by development of a dispensing holder that takes 26 different rolls. Round plywood discs serve as cores for the rolls of tape. Each disc has its own $\frac{1}{4}$ -in. steel shaft projecting about $\frac{1}{8}$ in. on each side. The shafts fit into slots in upright partitions, so that rolls of tape may be replaced individually. Serrated metal cutoff strips like those on individual tape dispensers were obtained from Minnesota Mining & Mfg. Co. and bolted to metal supporting straps. A welded metal version of the holder proved equally effective but was many times higher in fabrication cost.

When metal wire-holding clips for cable boards were hard to get, methods engineers at Federal Telephone and Radio Corp.'s Clifton plant switched to slotted wood pegs and found them equally effective. Slots are cut just a trifle narrower than the wire, and the hard maple wood used has enough spring to grip each wire end firmly yet permit easy removal.

Precut wires for cables of large industrial electronic equipment are supported within easy reach of the operator by a simple whirl-around holder in the Control Department at GE's Schenectady plant. Wires are looped over stiff metal rods projecting from the hub of the mount, arranged in the sequence needed by the operator. Tags on each rod identify the wire stored there. In

for ASSURED SAFETY

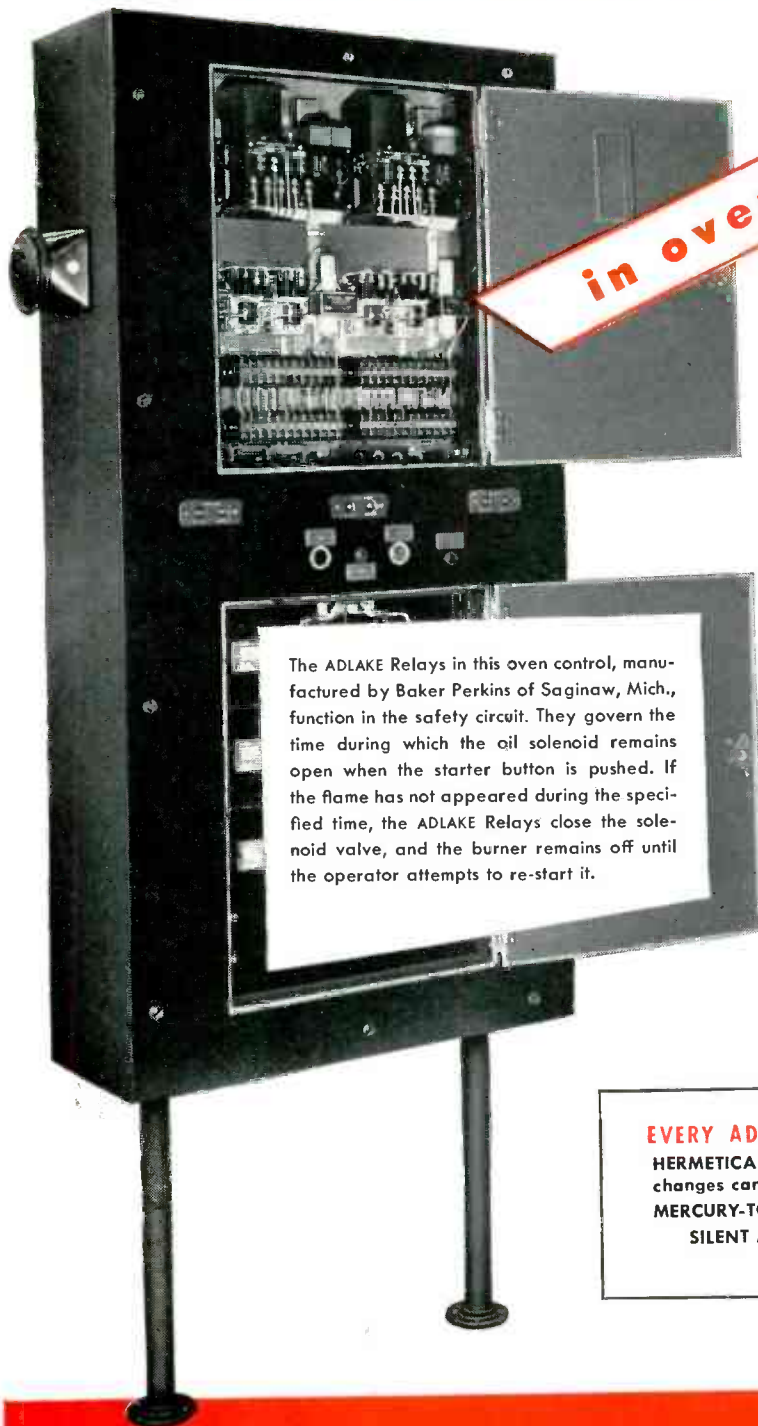

in oven operation

Baker Perkins uses **ADLAKE** mercury relays

Because of their dependability and positive action, ADLAKE Relays are used in the burner control circuits of Baker Perkins bakery equipment, where they have an important "watchdog" job to do (see panel).

It's no wonder that Baker Perkins, like so many other leading manufacturers, specifies ADLAKE Relays. For they are designed and built to meet the most exacting requirements. Their mercury-to-mercury contact prevents burning, pitting and sticking, and their sturdy construction armors them against outside vibration or impact. And most important of all, *they require no maintenance*, for they are hermetically sealed.

For the full story on the part ADLAKE Relays can play in *your* business, just drop a card to The Adams & Westlake Company, 1107 N. Michigan, Elkhart, Indiana. No obligation, of course.

The ADLAKE Relays in this oven control, manufactured by Baker Perkins of Saginaw, Mich., function in the safety circuit. They govern the time during which the oil solenoid remains open when the starter button is pushed. If the flame has not appeared during the specified time, the ADLAKE Relays close the solenoid valve, and the burner remains off until the operator attempts to re-start it.

EVERY ADLAKE RELAY BRINGS YOU THESE ADVANTAGES:

HERMETICALLY SEALED—dust, dirt, moisture, oxidation and temperature changes can't interfere with operation.

MERCURY-TO-MERCURY CONTACT—prevents burning, pitting and sticking.

SILENT AND CHATTERLESS • REQUIRES NO MAINTENANCE

ABSOLUTELY SAFE



THE Adams & Westlake COMPANY

Established 1857 • ELKHART, INDIANA • New York • Chicago
Manufacturers of ADLAKE Hermetically Sealed Mercury Relays

PRECISION-BUILT CHOPPERS YOU CAN DEPEND ON!

*made by AIRPAX . . .
pioneers in the field!*

A589 . . . 4 volt, 400 cycle drive, used widely by the industry. Highly reliable, field-proven, tested and approved by many major electronic and aircraft firms.



A580 . . . 120 volt, 400 cycle drive, supplied to 0 phase angle or with 80° to 90° lag. Most versatile . . . repeated tests show life in excess of 1000 hours.



A587 . . . 26 volt, 400 cycle drive . . . the phase of closure and break is held to close limits for interchangeable use as either modulator or demodulator.



A586 . . . 6 volt, 60 cycle drive, 45 phase lag. Here's a chopper so reliable that you can put it into service and forget it for thousands of hours!



MIDDLE RIVER, BALTIMORE 20, MD.

FOR HIGH-SPEED INDUSTRIAL SOLDERING

Use G-E

Calrod* Soldering Irons

HERE'S WHY THEY ARE PREFERRED BY . . .

PRODUCTION MEN . . . because they are built tough for long, continuous production line soldering. With calorized or ironclad tips, they stay clean, solder fast and can be easily disassembled.

MANAGEMENT MEN . . . G-E irons last longer and need less service. Exhaustive tests by some of the world's largest soldering iron users show that G-E irons save them money.

MAINTENANCE MEN . . . because superior features, like the cord-strain insulator which withstands a pull of 35 pounds, makes far less maintenance necessary. When it's occasionally necessary, the dependable G-E cartridge heater slips right out for servicing—just pull a pin.

FOR FREE BULLETIN, GEA-4519, ask your nearby G-E distributor, or write to: Sect. 720-66, General Electric Co., Schenectady, New York.

*Registered Trademark



GENERAL  ELECTRIC

720-66

Precision Gear Train

for STANDARD
SERVO BREADBOARDS

- 1 Ratios up to 15,000 to 1
- 2 Uniform transmission of torque with absolute minimum backlash
- 3 Face mounting may be provided for most control motors and electromechanical components

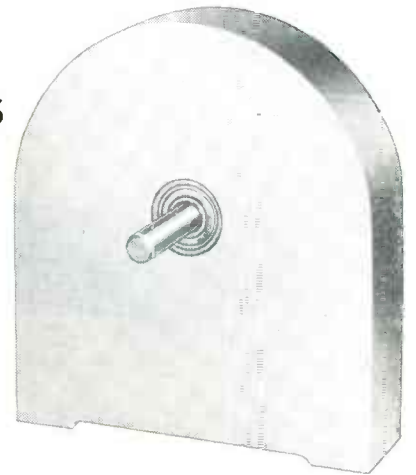

WE SPECIALIZE in the design and production of miniature precision gear trains built to your requirements for use in laboratory and JAN specification equipment. Send us your job specifications for our estimate today.

Bowmar Instrument Corp.

4214 Leo Road • Fort Wayne, Indiana • Tel. Eastbrook 4294

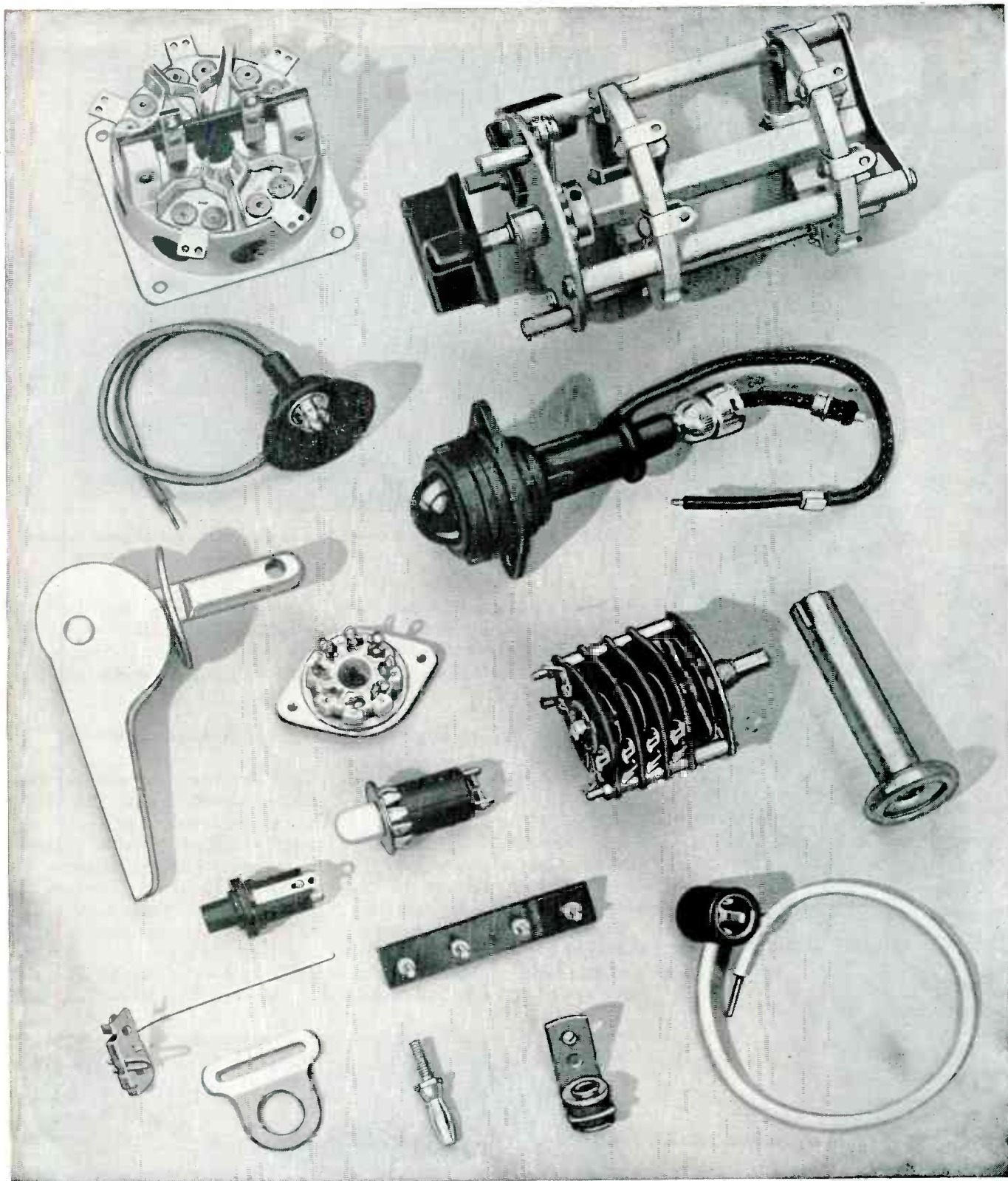

The UCINITE CO.

Newtonville 66, Mass.

Division of United-Carr Fastener Corp.

Specialists in
**ELECTRICAL ASSEMBLIES,
RADIO AND AUTOMOTIVE**

Guthman coil quality

controlled from
raw materials
to finished
components!

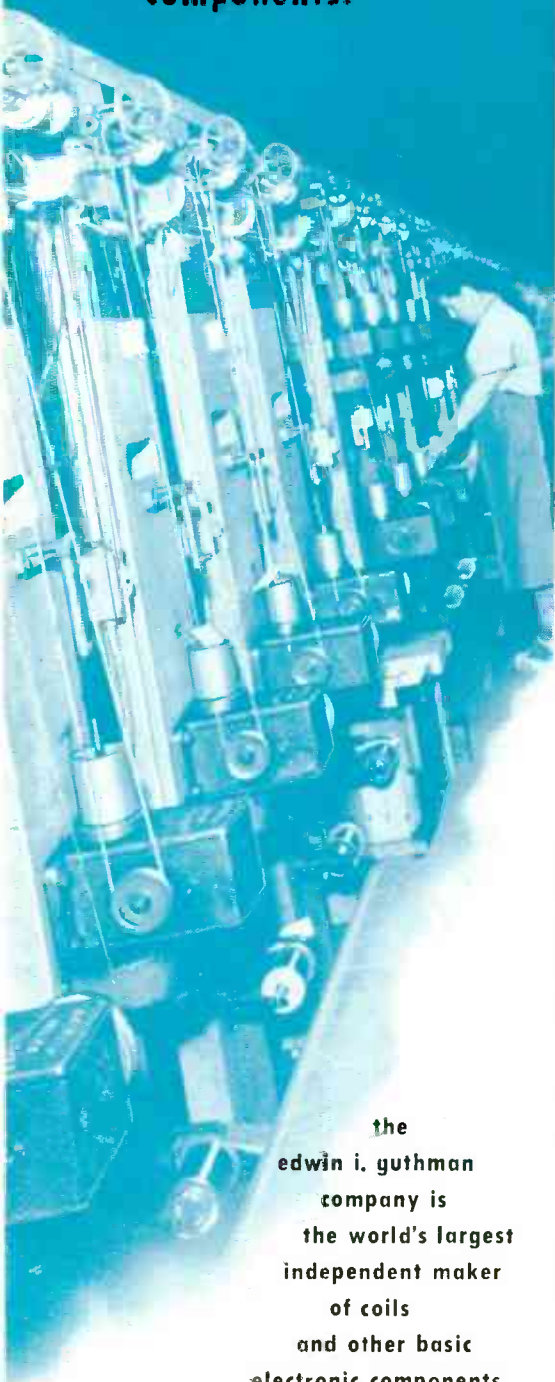

the
edwin i. guthman
company is
the world's largest
independent maker
of coils
and other basic
electronic components

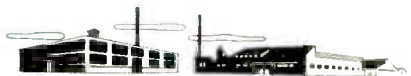

edwin i. guthman & co., inc.
15 s. throop st. chicago 7. . CH 3-1600
also ottica, indiana .

PRODUCTION TECHNIQUES

(continued)



Holder for precut lengths of wire used in forming cable harness at GE plant. Circular wood rim is convenient for turning holder. Spool of lacing cord is on top

addition, individual wires are identified by printing or hot stamping on the insulation at each end. A rim supported by four wood spokes

facilitates turning the holder. A wood peg projecting up at the center holds the spool of lacing cord used for tying the wires together.

Detecting High-Loss Electrolytic Capacitors

DESPITE wide capacitance variations of electrolytics, the loss or dissipation factor of incoming units is indicated directly on the meter of a production-tester developed by Carl G. Braun, field engineer for Holiday-Hathaway Co., Boonton, N. J.

The new technique for detecting and rejecting high-loss capacitors is based upon use of the Technology Instrument Corp. type 320-A phase

meter in conjunction with the simple test circuit shown. The Variac serves principally to reduce the voltage applied to the electrolytic. The transformer isolates the ground of the power line from the ground of the phase meter. The value of the resistor used in series with the capacitor under test depends within a factor of 10 on C . If the capacitor is perfect, with



Setup for checking loss of electrolytics as fast as they can be placed across a pair of test terminals

**NOW YOU CAN
SET-BUILDING**

**CUT
COSTS**

...WITH CONFIDENCE

Sylvania proudly presents 2 Zero Focus Voltage Picture Tubes

Paring anything off television set costs is a tough problem for today's designers. Sure, there are ways . . . and ways, but naturally you have a fine reputation to maintain. You want *confidence* as well as cost cutting.

And, that's just what Sylvania offers you. Now we proudly present 2 Zero Focus Voltage Electrostatic Picture Tubes . . . quality tested to assure finest possible performance, PLUS real design savings.

Types 17RP4 and 21FP4

These new Sylvania tubes are electrostatic focus, magnetic deflection, all-glass direct-view picture tubes.

Outstanding Savings result from the elimination not only of focus coils and fixed magnets, but also potentiometers and condensers to adjust focus voltage.

Special features of these new tubes include: (1) a neutral filter face plate which greatly improves picture contrast; (2) the ion trap gun which focuses at zero voltage; (3) an external conductive coating that acts as a filter condenser.

Critical Materials are Saved, too. The elimination of magnets and other components conserves your allotments of cobalt, nickel, and copper . . . prevents plant tie-ups and costly delays. Complete data sheets for both these tubes are now available. For your free copies address: Sylvania Electric Products Inc., Dept. R-1402, Emporium, Pa.



**SYLVANIA
17RP4**



**SYLVANIA
21FP4
cylindrical
face plate**

 **SYLVANIA** 

RADIO TUBES; TELEVISION PICTURE TUBES; ELECTRONIC PRODUCTS; ELECTRONIC TEST EQUIPMENT; FLUORESCENT TUBES, FIXTURES, SIGN TUBING, WIRING DEVICES; LIGHT BULBS; PHOTOLAMPS; TELEVISION SETS

Kahle

SPECIALISTS IN
HIGH-SPEED

electron tube machinery

Kahle's 40 years of experience eliminate trial orders and experimental set-ups. Standard toolings for all tube manufacturing eventualities already have been tested and approved. This means that Kahle can assemble machines for everything from sub-miniature to largest TV picture tubes to your exact specifications . . . at lower costs!

Kahle

ENGINEERING CO.

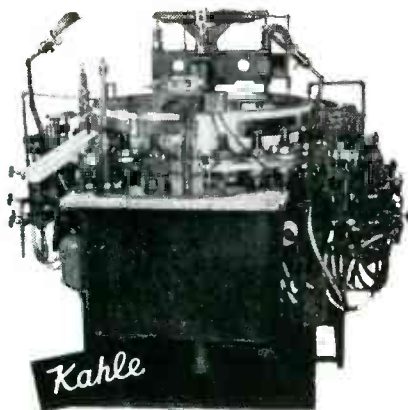

#1197 BUTTON STEM MACHINE for MINIATURE TUBES (24 Head) For miniature and sub-miniature tubes. Two upper molds for making non-tubulated stems with short lead wires. Dual motor drive. Capacity 1000 per hour.

Machinery for all types of electron tubes and related glass products.

Consultations invited. Write today for our new catalog with complete details.



1309 Seventh St., North Bergen, N. J.

PHYSICISTS

And

SENIOR RESEARCH ENGINEERS

• • •

POSITIONS NOW OPEN

• • •

Senior Engineers and Physicists having outstanding academic background and experience in the fields of:

- Microwave Techniques
- Moving Target Indication
- Servomechanisms
- Applied Physics
- Gyroscopic Equipment
- Optical Equipment
- Computers
- Pulse Techniques
- Radar
- Fire Control
- Circuit Analysis
- Autopilot Design
- Applied Mathematics
- Electronic Subminiaturization
- Instrument Design
- Automatic Production Equipment
- Test Equipment
- Electronic Design
- Flight Test Instrumentation

are offered excellent working conditions and opportunities for advancement in our Aerophysics Laboratory. Salaries are commensurate with ability, experience and background. Send information as to age, education, experience and work preference to:

NORTH AMERICAN AVIATION, INC.
Aerophysics Laboratory
Box No. K-4, 12214 S. Lakewood Blvd.
DOWNEY, CALIFORNIA

easily mounted

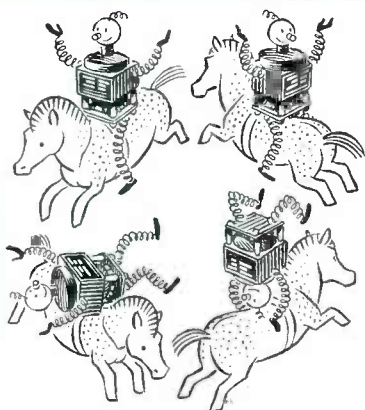

in any position, altho designed for vertical mounting. Back mounting or front mounting.

AN

AGASTAT

TIME DELAY RELAY for every requirement

AGA 1027 NEWARK AVE., ELIZABETH 3 NEW JERSEY



AGASTAT
TIME DELAY
RELAY



STIMSONITE
REFLECTORS



AIRPORT
LIGHTING



MARINE
LIGHTING
EQUIPMENT

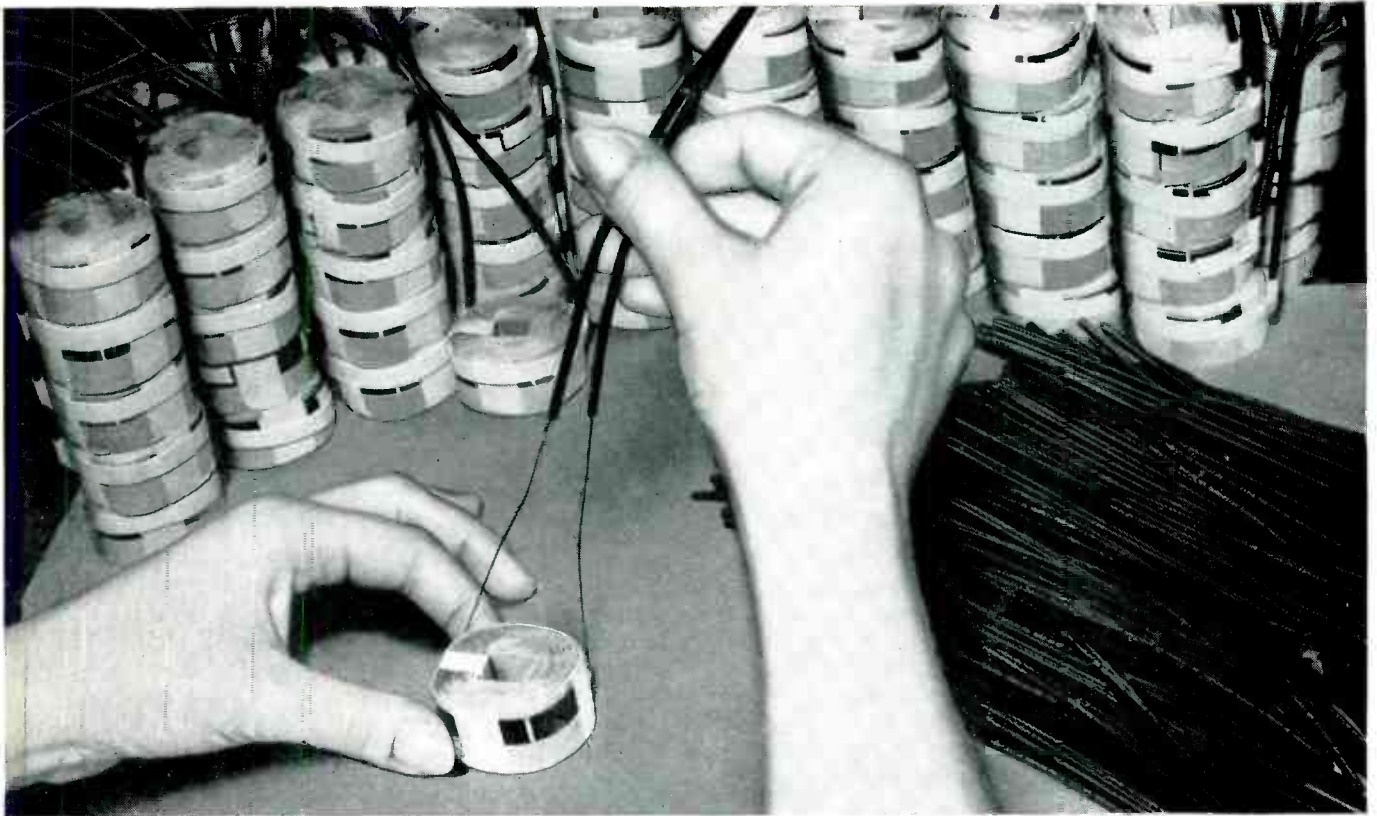

Minneapolis-Honeywell eliminates soldering operations . . . by slipping **TEMFLEX 105** over coil leads

Quantity use of Temflex 105 flexible plastic tubing effects substantial savings in assembly costs of the RA 117 Protectorelay oil burner control, according to Minneapolis-Honeywell Regulator Company, makers of the famous MH Control Systems and Brown Instruments. Assembly of the control calls for suitable insulation of two lead wires from each of two coils of the type shown in the illustration. Conventional methods would call for clipping off the lead wires close to the coils, and making soldered joints to insulated wires — calling for four soldering operations for each control.

But Minneapolis-Honeywell merely slips a length of Temflex 105 over each lead. **RESULT:** Soldering operations are eliminated . . . leads are thoroughly insulated, remain flexible . . . assembly costs are cut down.

Service advantages of Temflex 105 — in this and many other applications — are even more outstanding. This Irvington tubing is approved by Underwriters' Laboratories for 90° C operation in oil — as well as for continuous operation at 105° C. In addition to this superior oil resistance, Temflex 105 offers good resistance to mineral and coal tar solvents — and prolonged exposure to acids and alkalis has little effect on its initial high dielectric strength of 1200 vpm.

Get the full facts on Temflex 105 — mail the coupon for free technical data sheet.

Look to
IRVINGTON
for insulation leadership
INSULATING VARNISHES
VARNISHED CAMBRIC
VARNISHED PAPER
VARNISHED FIBERGLAS
INSULATING TUBING
CLASS "H" INSULATION



Send this convenient coupon now

Irvington

VARNISH & INSULATOR COMPANY

Irvington 11, New Jersey

Plants: Irvington N. J.; El Monte, Calif.; Hamilton, Ontario, Canada

For Further Information, Consult pages 92-93 in the 1951-1952 Electronics Buyers' Guide

Irvington Varnish & Insulator Co.
6 Argyle Terrace, Irvington 11, N. J.

Gentlemen:

Please send me your technical data sheet on Temflex 105 Plastic Tubing.

Name..... Title.....

Company.....

Street.....

City..... Zone..... State.....

EL-2/52

NEW ELECTRONIC FILTERS

BAND PASS • REJECTION • SERVO

MODEL
330-A
BAND-PASS



0.02 to 2,000 cps.
24 db/octave each side

Maximum attenuation greater than 80 db. Unity pass band gain.

MODEL
350-A
REJECTION

Band rejection or sharp null filtering. Unity gain outside rejection region.

EACH MODEL FEATURES

- High and low cut-off frequencies independently tuned over the entire frequency range
- Adjustable center frequency
- Adjustable band width
- 24 db/octave attenuation rates with peaking to reduce corner frequency attenuation
- Single scale logarithmic dials
- Five decade bands
- Internal noise less than 100 microvolts
- Maximum input signal 10 volts
- Output impedance 500 ohms or 5,000 ohms
- Input and output buffer stages
- Electronic regulated supplies
- Excellent gain and calibration constancy
- Price \$450.

MODEL
340-A
SERVO-DESIGN

0.01 to 100 cps.



For use in the d-c path of a servo loop to obtain either proportional-plus-integral or proportional-plus-derivative correction for experimental determination of optimum filter characteristics.

- Direct reading in frequency and attenuation ratio
- Single scale logarithmic dials
- Four decade bands
- Input and output buffer stages
- Electronic regulated supplies
- Filament drift cancellation
- Good gain and calibration constancy
- Price \$350.

MODEL
310-A
BAND-PASS

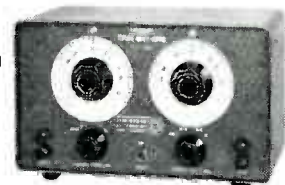

20 to 200,000 cps.
24 db/octave each side

Maximum attenuation greater than 60 db. Unity pass band gain.

MODEL
360-A
REJECTION

Band rejection or sharp null filtering. Unity gain outside rejection region.

EACH MODEL FEATURES

- High and low cut-off frequencies independently tuned over entire frequency range
- Adjustable center frequency
- Adjustable band width
- 24 db/octave attenuation rates with peaking to reduce corner frequency attenuation
- Single scale logarithmic dials
- Four decade bands
- Internal noise less than 5 millivolts
- Maximum input signal 5 volts
- Output impedance 500 ohms
- Input and output buffers
- Good gain and calibration constancy
- Small size
- Price \$275.

All KROHN-HITE Instruments are fully guaranteed for one year against defective materials and workmanship.

KROHN-HITE INSTRUMENT
Company



DEPT. E 580 MASSACHUSETTS AVE. CAMBRIDGE 39, MASS. U.S.A.

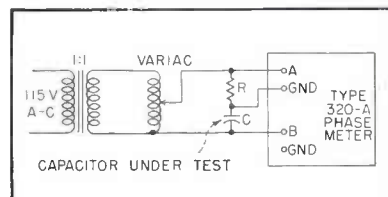

Test circuit used with phase meter

zero loss, the meter reads 90 degrees. If the capacitor has loss due to shunt or series internal resistance, the meter reads less than 90 degrees depending on the amount of loss and the size of C.

The meter scale may be revised to read dissipation factor directly, but in production tests it is usually only necessary to check that the angle measured is above some minimum value, using the "red-line" technique.

Paper Containers Cut Potting Costs

CHANGING from conventional iron mixing and pouring pots to paper containers reduced the cost of potting a military electronic component by 21¢ per unit at Emerson's Jersey City plant. The new production technique, introduced by chief methods engineer Tom Bellavia, eliminates cleaning of iron pots every 20 minutes with expensive and nauseating xylol solvent.

The conical paper cup now used is thrown away when empty. For pouring, the tip of the paper cup is cut off with scissors. A wood dowel rod held over the resulting hole



Demonstrating Emerson's use of conical paper cup and dowel-rod valve for filling containers with potting compound. Military classification prevents showing actual component. Compound is mixed in gallon icecream container at left

Rauland—the Original

LOW FOCUS VOLTAGE ELECTROSTATIC TUBE

**Perfected in Rauland Electronics Laboratories,
this tube that gives edge-to-edge sharpness of focus
without coils and magnets is proved and ready
as the materials pinch becomes painful**

BETTER in all ways! Gives better over-all focus—hair-line sharpness from edge-to-edge—with NO critical materials for focusing . . . and **STAYS SHARP** under considerable variation in line voltages.

REQUIRES NO re-engineering of present television chassis . . . NO added high voltage focus circuit . . . NO added receiver tubes . . . NO additional components except an inexpensive potentiometer or resistor.

FOCUSES by using D.C. voltage already available in the receiver.

ELIMINATES focusing coils and magnets . . . saves critically scarce copper and cobalt.

• • •

This new Rauland development is now available in substantial quantities in 17 and 20 inch rectangular tubes. For further information, address . . .

THE RAULAND CORPORATION



Perfection Through Research

4245 N. KNOX AVENUE • CHICAGO 41, ILLINOIS



ATR

For
AC CURRENT ANYWHERE



STANDARD AND HEAVY DUTY INVERTERS

For Inverting D. C. to A. C. . . .
Specially Designed for operating A. C. Radios, Television Sets, Amplifiers, Address Systems, and Radio Test Equipment from D. C. Voltages in Vehicles, Ships, Trains, Planes and in D.C. Districts.

ATR ✓ NEW MODELS
✓ NEW DESIGNS
✓ NEW LITERATURE

"A" Battery Eliminators, DC-AC Inverters, Auto Radio Vibrators
See your jobber or write factory

AMERICAN TELEVISION & RADIO CO.
Quality Products Since 1931
SAINT PAUL 1, MINNESOTA-U.S.A.

Assurance of correctly designed and applied POWDERED METAL PARTS...

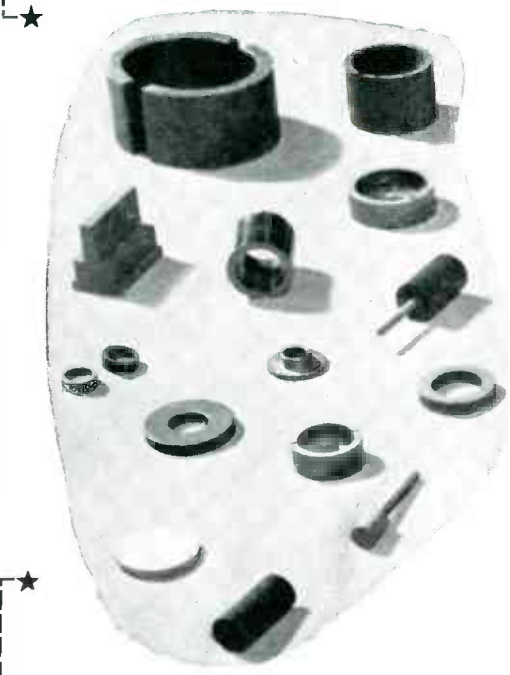

- ELECTRONIC PARTS
- MAGNETIC CORES
- MECHANICAL PARTS
- PERMANENT MAGNETS
- POROUS FILTERS and ORDNANCE PARTS

Consider Radio Cores' engineering experience and manufacturing ability in your plans for increased product quality, more simplified processes, and lower cost production.

RADIO CORES INC.

9546 TULLEY AVE.
OAK LAWN, ILL. (Adjacent Chicago)

Write for descriptive brochure and data sheets.

Millions of Coils

wound on **PARAMOUNT Paper Tubes**

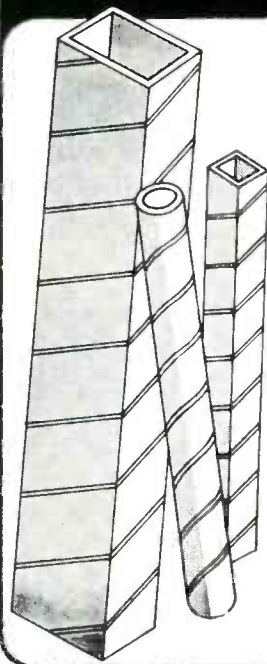

Stock Arbors or Special Tubes to Meet Every Need
SQUARE, ROUND, RECTANGULAR
.450" to 25" I.P. 1/2" to 30" long. Tolerances $\pm .002"$

You find **PARAMOUNT** Spiral Wound Paper Tubes at the core of coil dependability in nationally known products and equipment. That's proof they're *made right to wind right* and *stay right* on the job. Hi-Dielectric. Hi-Strength. Kraft, Fish Paper, Red Rope, or any combination, wound on automatic machines.

NEW! Shellac-Bound Kraft paper tubing. Heated shellac forms an adhesive bond between the laminations. Absolutely moisture resistant.

SEND FOR ARBOR LIST OF OVER 1000 SIZES

Write on company letterhead for stock arbor list. Includes many odd sizes.

Paramount PAPER TUBE CORP.

616 LAFAYETTE ST., FORT WAYNE, IND.

Mfrs. of Paper Tubing for the Electrical Industry

New 1952 HEATHKITS

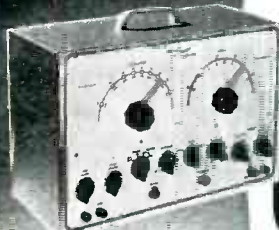

Heathkit
TELEVISION
GEN. KIT \$39.50



Heathkit
ELECTRONIC
SWITCH KIT \$19.50

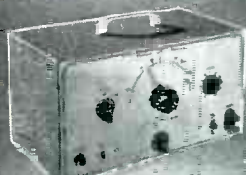

Heathkit
AUDIO GEN.
KIT \$34.50



Heathkit
CONDENSER
CHECKER KIT \$19.50



Heathkit
R. F. SIGNAL
GEN. KIT \$19.50



Heathkit
A.C. VOLTMETER
KIT \$29.50

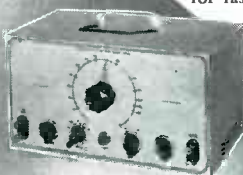

Heathkit
SQUARE WAVE
GEN. KIT \$29.50



Heathkit
INTERMODULATION
ANALYZER KIT \$39.50



Heathkit
AUDIO FREQ.
METER KIT \$34.50

Heathkit 5" OSCILLOSCOPE KIT

- New "spot shape" control for spot adjustment — to give really sharp focusing.
- A total of ten tubes including CR tube and five miniatures.
- Cascaded vertical amplifiers followed by phase splitter and balanced push-pull deflection amplifiers.
- Greatly reduced retrace time.
- Step attenuated — frequency compensated — cathode follower vertical input.
- Low impedance vertical gain control for minimum distortion.
- New mounting of phase splitter and deflection amplifier tubes near CR tube base.
- Greatly simplified wiring layout.
- Increased frequency response — useful to 5 MC.
- Tremendous sensitivity 0.3 RMS per inch Vertical, 6V RMS per inch Hor.
- Dual control in vernier sweep frequency circuit — smoother acting.
- Positive or negative peak internal synchronization.
- Multivibrator type Wide Range Sweep Generator.

A brand new 1952 Heathkit Oscilloscope Kit with a multitude of outstanding features and really excellent performance. A scope you'll truly like and certainly want to own.

The kit is complete with all parts including all tubes, power transformer, punched and formed chassis, etc. Detailed instruction manual makes assembly simple and clear — contains step-by-step instructions, pictorials, diagrams, schematic, circuit description and uses of scope. A truly outstanding value.

MODEL 0-7
SHIPPING WT. 24 LBS.

\$43.50

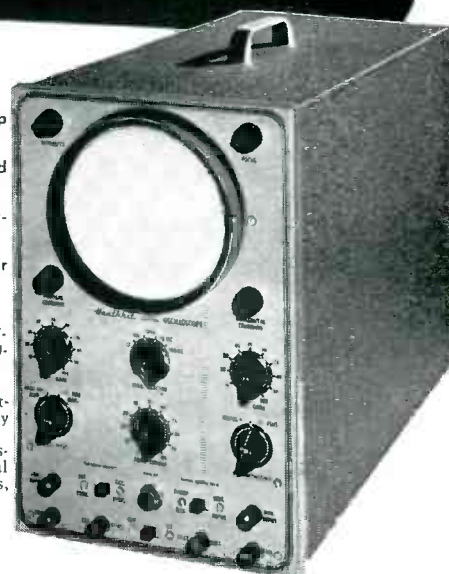

Heathkit VACUUM TUBE VOLTMETER KIT

- New styling — formid case for beauty.
- New truly compact size — Cabinet 4 1/8" deep x 4-1/16" wide x 7 7/8" high.
- Quality Simpson 200 microamp meter.
- New ohms battery holding clamp and spring clip — assurance of good electrical contact.
- Highest quality precision resistors in multiplier circuit.
- Calibrates on both AC and DC for maximum accuracy.
- Terrific coverage — Reads from 1/2V to 1000V AC, 1/2V to 1000V DC, and 1 to over 1 billion ohms resistance.
- Large, clearly marked meter scales indicate ohms, AC Volts, DC Volts, and DB — has zero set mark for FM alignment.
- New styling presents attractive and professional appearance.

The 1952 Model Heathkit Vacuum Tube Voltmeter! Newly designed cabinet combines style and beauty with compactness. Greatly reduced size to occupy a minimum of space on your work-bench. Covers a tremendous range of measurements and is easy to use. Uses only quality components including 1% precision resistors in multiplier circuit for greatest accuracy. Simpson 200 microamp meter with easy to read scales for fast and sure readings.

All parts come right with kit, and complete instruction manual makes assembly a cinch.

MODEL V-5
SHIPPING WT. 5 LBS.

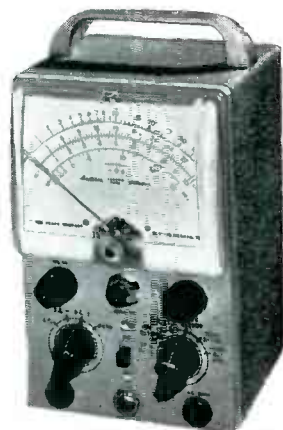

\$24.50

YOU SAVE BY ORDERING DIRECT FROM MANUFACTURER

EXPORT AGENT
ROCKE INTERNATIONAL CORP.
12 E. 40th ST.
NEW YORK 17, N.Y.
CABLE: APLM:INS

The **HEATH COMPANY**

BENTON HARBOR 14, MICHIGAN

FULL RANGE OF MIL-T-27 TRANSFORMERS

HERMETICALLY SEALED UNITS

NYT hermetically sealed transformers are available in all standard sizes to meet MIL-T-27 specifications, and especially designed constructions for a wide variety of military as well as civilian applications. Designed and built to meet the most exacting specifications. Production facilities for quantity production of all sizes.

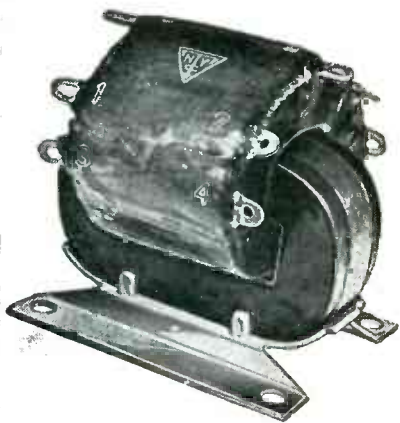

the HORNET

HORNET transformers, pioneered by NYT, are of open type construction, utilizing Class H insulating materials. Approximately one-fourth the size and weight of comparable Class A units. Filament and plate supply transformers and chokes. Units can be designed for ambients up to 190 deg. C., altitudes up to 60,000 feet; power ratings from 2VA to 5KVA.

**POWER, AUDIO, FILAMENT
and PLATE TRANSFORMERS
REACTORS • FILTERS • CHOKES
TV • RADIO • ELECTRONICS**



Engineering and development facilities

**NEW YORK
TRANSFORMER CO., INC.**
ALPHA, NEW JERSEY

PRODUCTION TECHNIQUES

(continued)

serves as a pouring valve. The dowel rod is alternately raised and lowered as the cup is moved over a tray of units awaiting potting, to start and stop the flow of potting compound without drip. The cups fit in a simple metal holder. Dowel rods are discarded when compound hardens on them, as new rods are cheaper than the cost of cleaning them.

For initial mixing of potting compound, formerly used 2-quart porcelain pots have been replaced with disposable 1-gallon icecream



Pouring resin from disposable paper cup into mold containing Hamilton Standard's electronic subassembly for controlling flow of fuel to aircraft gas-turbine engines. Potted units, after removal from mold, are shown in foreground

containers costing 13¢ each in 1,000 lots. These containers are discarded when empty, eliminating the cost of cleaning porcelain containers. The faster pouring rate made possible by use of paper cups permits mixing twice as much compound as before and still using it up before thickening starts. Of the total saving, 11¢ per unit is due to use of gallon paper containers and 10¢ per unit to use of Lily conical paper cups for pouring. Similar savings are being obtained by using papers cups for pouring other potting compounds.

Conventional flat-bottom paper cups are used for over-the-lip pouring of quick-hardening resin during potting of tiny electronic sub-

Q

• Are all brands of Resistors similar in Quality,
• Specifications and Performance?

A

• Naturally, no! That's why **DAVEN** has earned
• the right to add a superlative in naming its line

• Brands of Resistors vary as widely in the completeness of a line and in performance, as do brands of any other product.

DAVEN originated the first pie-type, wire wound Resistor more than a generation ago. Since that time, DAVEN has designed and manufactured Precision Wire Wound Resistors of every conceivable type to meet the increasing demands of the electronics industry.

SUPER DAVOHM RESISTORS are noted for their high stability and accuracy under extreme temperature and humidity conditions. DAVEN Resistors are made in accordance with JAN-R-93 specifications and are in use in all types of Army, Navy and Air Force electronic equipment.

DAVEN has developed special small precision Resistors for use in miniaturized assemblies. All types of mountings, sizes, tolerances and temperature coefficients are available from a large variety of standard types. That's why DAVEN can fill your precision Resistor needs.

Take advantage of DAVEN's advanced engineering and manufacturing techniques to help with any Resistor problem confronting you.

SUPER DAVOHM

PRECISION WIRE WOUND

RESISTORS

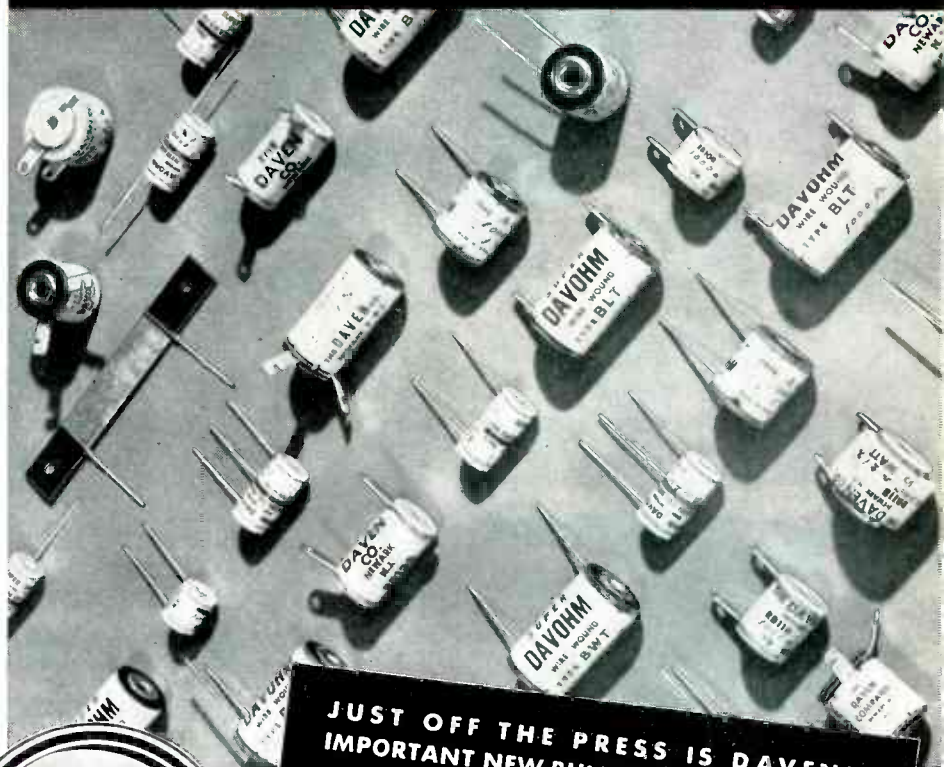

JUST OFF THE PRESS IS DAVEN'S
IMPORTANT NEW BULLETIN ON RESISTORS.

Write for your copy today and prove to yourself, from the information supplied, that when you order Resistors you should specify only . . .

SUPER DAVOHM Precision Wire Wound RESISTORS

THE **DAVEN** CO.

191 CENTRAL AVENUE
NEWARK 4, NEW JERSEY



NOW scientific

Chart Control

maintains
definite quality
standards for these
and other dimensions
and characteristics of
ALLEN  **SCREWS**



1. Head radii
2. Head diameter
3. Body diameter
4. Thread form
5. Lead error
6. Thread size
7. Rockwell hardness
8. Head - Body - Thread concentricity
9. Head height
10. Socket size and depth



WARNING
Allen-Type screws aren't necessarily Allen-Made. Get genuine "Pressur-Formed" Allen  Head screws in this black and silver box.

THE ALLEN
MANUFACTURING COMPANY
Hartford 2, Connecticut, U. S. A.

For Sub-Panel and Chassis

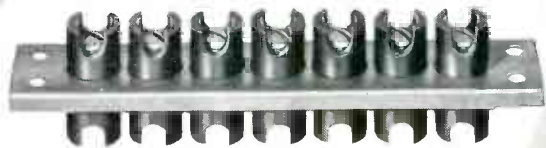

CURTIS
Type "FT"
BLOCKS

TYPE:
Feed-thru, factory assembled
1 to 16 terminals.

TERMINALS:
Screw-type — separately insu-
lated, held permanently in
metal strip.

RATED:
300 Volts between terminals
of opposite polarity and to
ground. 20 Amps. (Conserva-
tive).

Write for Bulletin DS-111. For quick reference consult our condensed catalog in the McGraw-Hill Electrical Catalog for Production Engineers.

CURTIS DEVELOPMENT & MFG. CO.

3203 NORTH 33rd STREET • MILWAUKEE 16, WISCONSIN

Only with **CO-A-X**

AIR SPACED ARTICULATED

R.F. CABLES

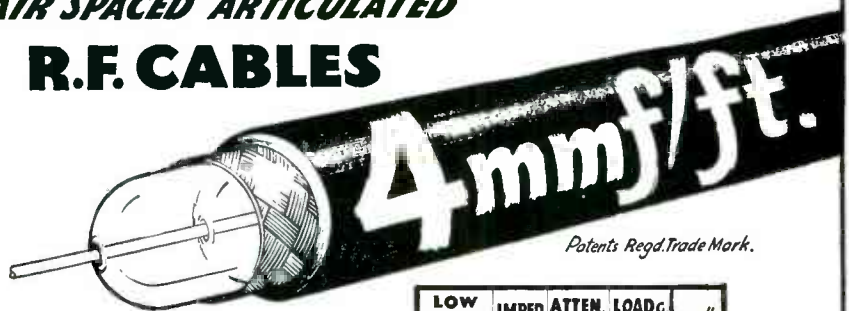

Patents Regd. Trade Mark.

THE LOWEST EVER
CAPACITANCE OR
ATTENUATION

We are specially organized to handle direct enquiries from overseas and
Give IMMEDIATE DELIVERIES FOR U.S.A.
Billed in dollars. Settlement by your check.

TRANSRADIO LTD

CONTRACTORS TO H.M. GOVERNMENT.

138A CROMWELL ROAD, LONDON SW7 ENGLAND
CABLES: TRANSRAD LONDON.

LOW ATTEN. Types.	IMPED. Ohms.	ATTEN. db/100ft. of 100 Mcs.	LOADG. Kw.	OD"
A.1.	74	1.7	0.11	0.36
A 2	74	1.3	0.24	0.44
A34	73	0.6	1.5	0.88

LOW CAPAC. Types	CAPAC. mmf/ft.	IMPED. Ohms.	ATTEN. db/100ft. of 100 Mcs.	OD"
C 1	7.3	150	2.5	0.36
PC1	10.2	132	3.1	0.36
C 11	6.3	173	3.2	0.36
C 2	6.3	171	2.15	0.44
C 22	5.5	184	2.8	0.44
C 3	5.4	197	1.9	0.64
C33	4.8	220	2.4	0.64
C44	4.1	252	2.1	1.03

HIGH POWER FLEXIBLE

PHOTOCELL CABLE

VERY LOW CAPACITANCE

A TIMELY MESSAGE

for America's Electrical and Electronic Manufacturers

IN THE 1952 PRODUCTION PICTURE a more-essential-than-ever part will be played by Federal Selenium Rectifiers:

- 1—Because** selenium rectifiers have an almost limitless variety of uses—the result of tremendous advances made in techniques and applications since these unique AC-to-DC power conversion components were introduced to the U. S. in 1938 by Federal.
- 2—Because** selenium rectifiers definitely save critical materials, such as copper and steel.
- 3—Because** selenium rectifiers definitely save high-priced, hard-to-get manpower—through simplifying equipment designs, reducing component needs and eliminating numerous production and assembly operations.

THESE ARE THE MAIN REASONS why manufacturers of electrical and electronic products will find it advantageous and profitable—*especially in times of allocations and shortages*—to utilize the distinctive qualities and immense versatility of Federal Selenium Rectifiers.

IN MANY INDUSTRIES Federal Selenium Rectifiers are firmly established as a compact, rugged, silent and dependable source of DC power—being used for power supplies, battery chargers, voltage regulators, engine starters, cathodic protection and other units, as well as heavy equipments such as power generators.

SINCE 1946, when Federal introduced its now-famous *miniature* selenium rectifier, 30,000,000 units of this type have been shipped to the field—for installation in radio and TV receivers—to replace rectifier tubes, save space and weight and eliminate costly or scarce components.

BACKED BY YEARS of outstanding accomplishments in power conversion engineering for industrial and military requirements, and offering opportunities singularly pertinent to present-day supply conditions, Federal Selenium Rectifiers are a logical, dependable and economical answer to many of the DC power problems now confronting manufacturers.

Let us prove it by sending you complete, up-to-the-minute data on your particular specifications. Write to Dept. F-813.

"America's Oldest and Largest Manufacturer of Selenium Rectifiers"

Federal Telephone and Radio Corporation

SELENIUM-INTELIN DIVISION, 100 Kingsland Road, Clifton, N. J.

In Canada: Federal Electric Manufacturing Company, Ltd., Montreal, P. Q.

Export Distributors: International Standard Electric Corp., 67 Broad St., N. Y.



Plastic Reamers Molded for Westinghouse Electric Fruit Juicer Include Metal Shaft Inserts

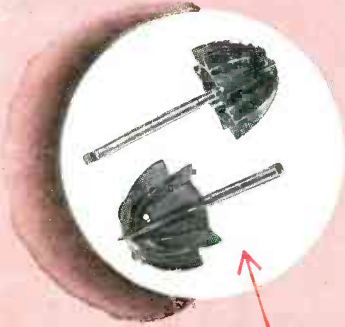

Tool Handle for "Home Utility" Sander-Polisher Molded for Black and Decker, Producers of Famous Portable Electric Tools



Terminal Block with Metal Inserts Molded for the Crocker-Wheeler Division of Elliot Company, A Leading Producer of Electric Motors

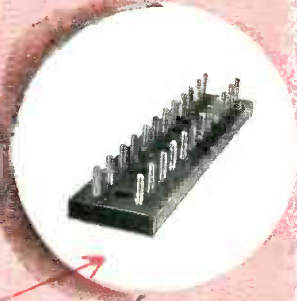

Instrument Knob Molded for Leeds & Northrup Company, Makers of Electrical Measuring Instruments, Automatic Controls and Heat Treating Furnaces



—FOR

electronic, television, communication and electrical applications

FROM 3 COMPLETE PLANTS

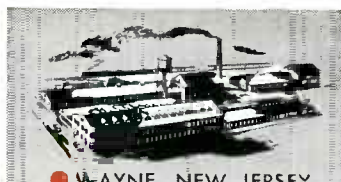

● WAYNE, NEW JERSEY



● SHELTON, VERMONT



● WATERLOO, P. Q. CAN

Mack



MOLDED EXCELLENCE

OVER 30 YEARS OF MOLDING SERVICE TO INDUSTRY

assemblies at United Aircraft's Hamilton Standard Division in East Hartford. Here again, cups are discarded when empty.

Leak Tester

AN ORDINARY vacuum cleaner, a water column, a tank of Freon gas and a Presto-lite plumber's torch are the essential elements in the technique employed at DuMont's East Paterson, N. J. plant for detecting and locating leaks in housings of military electronic equipment. One setup uses a dummy panel for checking the body housing, and another uses a dummy body for checking the gasketed cover panel.

For checking body units, the dummy panel is arranged for quick clamping to the body under test. Rubber hose goes from this panel to the valves of the system. With the dummy panel on a body, the vacuum cleaner is used to evacuate the body housing, with the water column serving as a visual indicator of the degree of vacuum. A valve in the vacuum cleaner line is then closed and the water column watched to see if the housing holds its vacuum. For the particular unit shown in production, tolerance limits permitted not more than a 1/8



Setup for detecting pinhole leaks in body housing of military electronic gear. Plumber's torch is on bench at left, next to dummy cover panel, and Freon gas tank is on floor at right

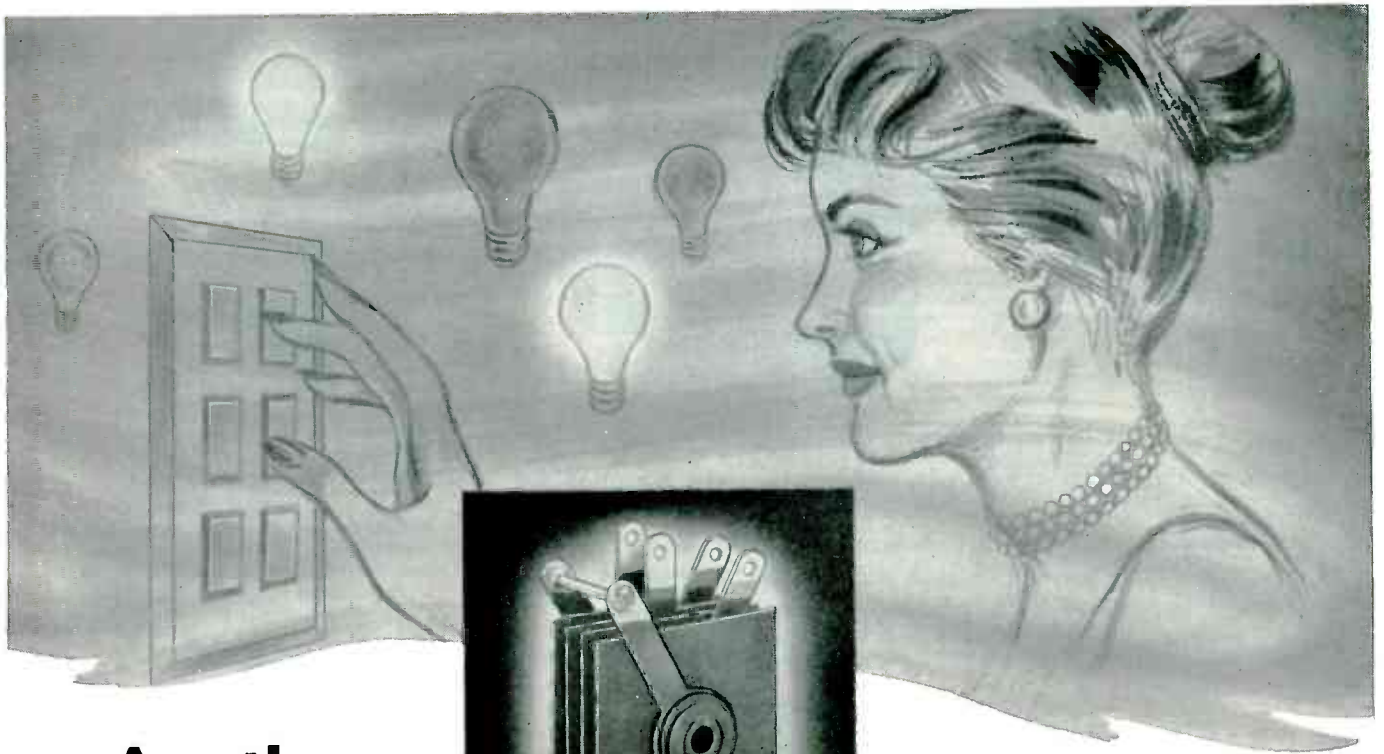

Another Unusual Seletron Application

Modern new low-voltage remote control light switch systems employs

Touch-Plate Mfg. Co. of Long Beach, Calif. considers the rectifier in each of its control units a highly important "artery" of the system . . . That's why, after severe tests for temperature, load capacity and longevity, they have chosen SELETRON Selenium Rectifiers.

The rectifier incorporated in "Touch-Plate" (Just touch it and the lights go on anywhere in the house!) is SELETRON's Model P1B1E1C, 1-3/16" cell size, and rated at 26V AC input. It converts AC to DC for the "Touch-Plate" relay.

SELETRON Selenium Rectifiers are available in ratings from a few mils, up to thousands of amps! New industrial electronic uses are *constantly* turning up for these versatile and dependable rectifiers—both in miniature sizes and heavy stack assemblies . . . and of course SELETRON is the choice of a growing list of manufacturers in communications and TV.

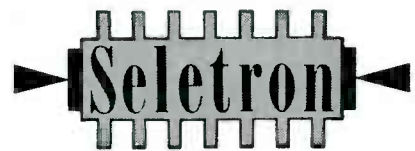

SELETRON SILENIUM RECTIFIERS

May we help with your rectification problems? Write us without obligation. Our engineering department can be of real assistance . . . And please ask for our helpful Bulletin No. 104-D-1.



**SELETRON DIVISION
RADIO RECEPTOR COMPANY, INC.**

RR Since 1922 in Radio and Electronics **RR**

SALES DEPT: 251 West 19th Street, New York 11, N. Y. • FACTORY: 84 North 9th Street, Brooklyn 11, N. Y.

SIGNAL ENGINEERING HEAVY DUTY MULTIPLE ARM RELAYS



Designed for high degree of versatility and to meet severe operating conditions where performance reliability is vital. Adaptable to many different circuit arrangements. Rigid, cast aluminum bodies. Balanced armature construction. Highly resistant to shock and vibration. Available A.C.-D.C. Also special models built for specific requirements.

Relay assemblies can be modified to meet Armed Services applications.

Submit your requirements for our recommendations.

Engineering Representatives in Principal Cities

Write for
Bulletin 30-6

ENGRAVING and MARKING

*The Green
Engraver*

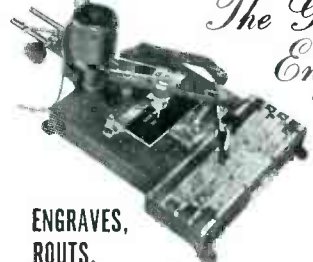

ENGRAVES,
ROUTES,
PROFILES and MODELS

A real money saver for industry. Proven by the experience of tool and die, electronic machine, radio, electrical and instrument manufacturers.

The Green Engraver zips out precision work on metal, plastics, wood, glass, hard rubber, etc. . . . engraves panels, name plates, scales, dials, molds, lenses, instruments, instruction plates, directional signs . . . by simple tracing. Routing, profiling and three dimensional modeling indicate its versatility. Electronic etching attachment available.

Specify the Green Engraver for the best in low cost performance.

Special attachments and engineering service available for production work.

FREE — Fact-packed folder yours upon request.

Pulse Generator and Calibrator



Model
PC-100 R
illustrated
here

- The Teletronics Model PC-100 Pulse Generator and Calibrator was designed as an accessory for general use with triggered oscilloscopes.
- However, the variety of waveforms generated and the flexibility of operation provided make it a valuable instrument for many other purposes.
- The Pulse Calibrator produces two rectangular pulses of short duration whose amplitudes and polarities can be independently controlled.
- Their repetition frequency and the time interval between them are also adjustable. Accurate marker pulses and square-waves are generated for making both time and amplitude measurements. The unit can be synchronized from an external source or it may be operated self-synchronous in which case a pulse for synchronizing other equipment is generated.

Incorporates design of
HAZELTINE
ELECTRONICS CORP.
Model 1456
Senior Pulser

For further information,
write or wire

MANUFACTURERS OF ELECTRONIC INSTRUMENTS AND PRODUCTION TEST EQUIPMENT

Linde
Trade-Mark

M. S. C.

(Mass Spectrometer Checked)

RARE GASES

HELIUM • NEON

ARGON • KRYPTON • XENON

LINDE Rare Gases are mass spectrometer checked to assure you gases of known purity and uniformly high quality. Available in commercial-size cylinders and glass bulbs.

LINDE, the world's largest producer of gases derived from the atmosphere, can meet your individual needs of purity...volume...mixture...containers...

LINDE AIR PRODUCTS COMPANY
A DIVISION OF UNION CARBIDE
AND CARBON CORPORATION

30 East 42nd Street  New York 17, N. Y.

In Canada:
Dominion Oxygen Company, Limited, Toronto

The term "Linde" is a registered trade-mark of Union Carbide and Carbon Corporation

IT'S TIME . . .
again . . .

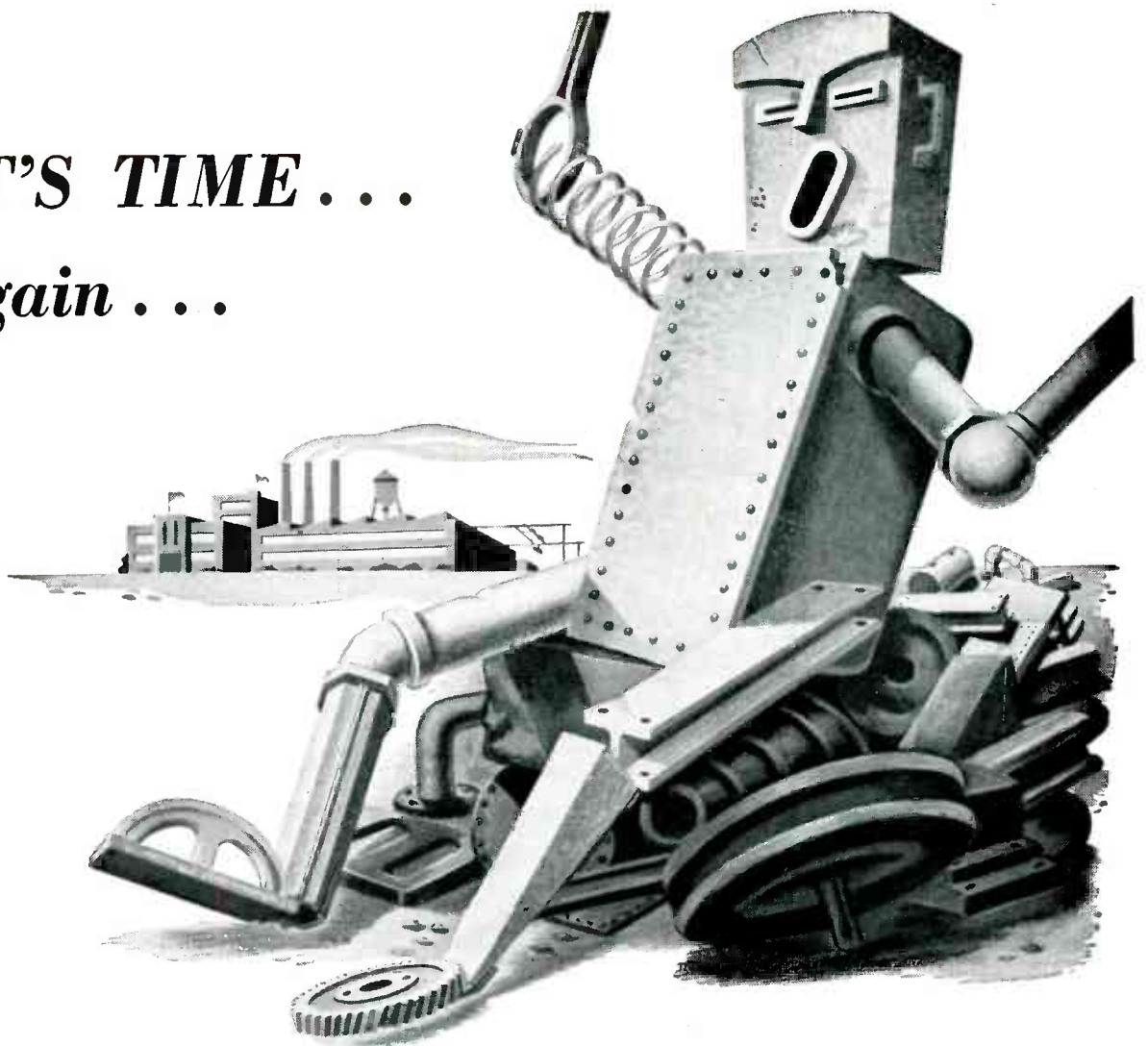

TO WAKE UP SCRAPPY!

Scrap's getting scarce again . . . compared to the amounts we need . . . and it's up to *all* of us to *help* produce enough steel.

107,000,000 tons of steel is the present rate of production in 1951 . . . 119,500,000 tons is expected in 1952.

Last year, 1950, we produced 97,800,000 tons.

All that extra steel—enough to take care of *both* military and civilian needs—calls for *more scrap iron and steel*.

Scrap Inventories Are Alarmingly Low

While steel mills are producing at a greater rate than ever, scrap inventories have dwindled. Many mills are operating on a hand-to-mouth basis with shut-downs

NON-FERROUS SCRAP IS NEEDED, TOO!

This advertisement is a contribution, in the national interest, by

McGraw-Hill Publishing Company, Inc.

330 WEST 42nd STREET

NEW YORK 18, N. Y.



threatened unless we furnish more scrap.

We *do* have the scrap. It's everywhere, not just in the form of *production* scrap—the “leavings” of machining, normally turned over to scrap dealers . . . but also in the form of *idle* metal: obsolete machines and tools, no-longer-usable jigs and fixtures, gears, chains, pulleys, valves, pipe, abandoned steel structures, etc.

We must have this *idle* metal to keep the furnaces running.

Please cooperate. Set up a Scrap Salvage Program in your plant—*now*. For a complete plan on “how to do it”, write for booklet “Top Management: Your Program for Emergency Scrap Recovery”. Address Advertising Council, 25 W. 45 Street, New York 19, N. Y.

Why Do We Need Scrap?

Steel is made half from pig iron, half from scrap. With production on the increase, more scrap must be purchased. And it's up to you to “dig it out” and sell it.

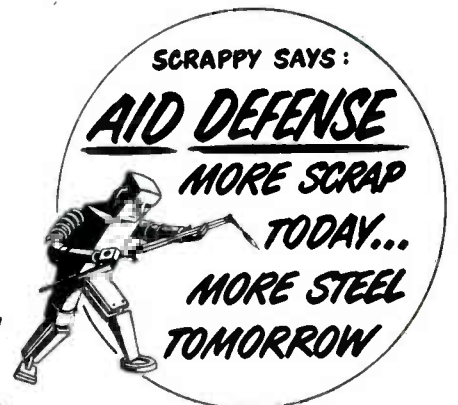



for better marking use

MARKEM[®]

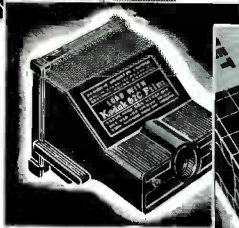

**FOR MARKING PRODUCTS,
PARTS, PACKAGES, TAPES,
TAGS, LABELS — FLAT, CUR-
VED, IRREGULAR SURFACES**

THE MARKEM METHOD

Markem machines, types, and inks constitute a better method for marking the products of industry. Markem equipment is engineered to solve special marking problems. Behind the Markem method lies nearly half a century of marking experience which may be applied to your marking problem.

MARKEM MARKING MACHINES

There is a Markem marking machine for practically every marking purpose—for *direct marking* of product packages, products, and product parts—for *imprinting* labels, tags, tapes, and special gummed, pressure-sensitive

or heat-seal backed material, or for producing *complete labels*. Makes up to many thousand durable imprints per hour on almost any kind of material. No special skill needed to operate. Legend and color of imprint quickly and easily changed.

MAKE YOUR MARK WITH MARKEM

Whether you make saws or sox, spark plugs or shoes, TV tubes or tachometers, drugs or hand grenades—whatever your marking problem—find out how easily and economically the Markem method can handle it. Just send a sample of the item to be marked and details of your needs to Markem Machine Company, Keene 5, New Hampshire.



**LABORATORY
CONTROL of
materials...**



means finer coil forms with

PRECISION PAPER TUBES

Precision's unique Laboratory Control Plan maintains higher material standards—offers you coil forms with better heat-dissipation and insulation, greater resistance to moisture. Also, spiral winding and die-forming under pressure provide 15% to 20% more strength with lighter weight—greater coil winding space.

Available in round, square, oval, rectangular, or any shape, length, ID or OD. Made to your exact specifications of finest dielectric Kraft, Fish Paper, Cellulose Acetate or combinations.

WRITE TODAY FOR FREE SAMPLE AND NEW MANDREL LIST OF OVER 1,000 SIZES

PRECISION PAPER TUBE CO.

2041 W. Charleston St.

Chicago 47, Ill.

Plant No. Two, 79 Chapel St., Hartford, Conn.

in. change in water column height in 30 seconds.

When a housing is outside of tolerance, Freon is admitted through another valve to the same pressure above atmospheric as the vacuum was below atmospheric. With the air intake of the plumber's torch modified so air enters only through an 18-inch length of rubber tubing, the torch is lighted and the end of the tubing is moved over the leaky housing as a searching probe. When Freon gas from a leak enters the torch flame, there is an immediate change from a normal blue flame to a yellow flame. A bad leak puts out the flame. The technique detects pinholes in metal as well as leaks around panel fittings.

The procedure for testing covers is the same except that now the rubber hose goes to a fitting on a dummy body. Separate tests of body and panel are important because the final military acceptance test involves submerging the completely assembled unit in water for a predetermined time, then opening to see if there is water inside.

Soldering Hermetic Seals

USE OF HEAT from a 375-watt Sylvania infrared reflector lamp for soldering small hermetic-seal terminals to the cover of a pulse transformer reduces thermal stress between glass and metal and thus cuts down the number of rejects due to



Using infrared heat to solder hermetic-seal terminals to thin metal cover

for **INSULATING WATER SYSTEMS**

for cooling High-Power Electron Tubes

For insulating the water system for water-cooled tubes, use of Lapp porcelain obviates troubles arising from water contamination and conductivity, sludging, and electrolytic attack of fittings.

Lapp porcelain, in pipe, coils and fittings is a completely vitrified, non-porous ceramic, non-deteriorating and chemically inert. It assures permanent cleanness and high resistance of cooling water, eliminates need for frequent inspection, changing of water or failure of the water system, provides positive cooling for long tube life.



LAPP PORCELAIN PIPE Inside pipe diameters of $\frac{3}{4}$, 1, $1\frac{1}{4}$, $1\frac{1}{2}$, 2 and 3". Available in straight pipe up to 60" lengths, 90° and 180° elbows, and fittings. All connections are swivel-type. Stand off insulators attach directly to bolts which hold pipe sections together. Metal fittings are bronze, polished heavy chrome plated.



LAPP PORCELAIN WATER COILS

Twin hole coils with inside pipe diameters $\frac{1}{4}$, $\frac{3}{4}$, 1". Single hole coils with inside pipe diameters $\frac{3}{8}$, $1\frac{1}{4}$, $1\frac{1}{2}$ ". Provide for flow of cooling water from 2 to 90 gal. per min. Coils provided with cast aluminum mounting bases, fittings, and three-foot sections of lead pipe for attachment to coil terminals.

Write for complete description and specifications. Radio Specialties Division, Lapp Insulator Co., Inc., Le Roy, N. Y.

Lapp

THOROUGH REFERENCE

on theories and engineering treatment of radiation phenomena

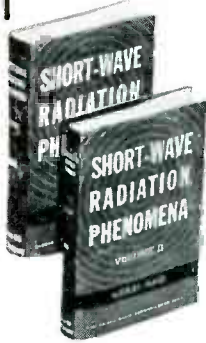

Here is an intensive, thoroughgoing reference and study of all radiation phenomena in practical use today—from frequencies of about 30 megacycles per second up to the highest radio frequency. Gives a wealth of data, theory, and formulas, together with a host of numerical examples. Covers resultant field intensities (so important in modern use) as well as free field intensities. Picks up where electromagnetic volumes leave off—to bring a complete understanding of every modern and classical radiation concept.

Just Published!

SHORT-WAVE RADIATION PHENOMENA

By AUGUST HUND

Scientific and Technical Radiation Consultant

McGRAW-HILL RADIO COMMUNICATION SERIES

Arranged for maximum ease of reference, these two volumes are invaluable to the designer as well as the research scientist. Whenever a practical radiation phenomenon is described, the derivation of the formula is given along with the description, so that you do not have to refer to preceding sections to understand a particular problem.

2 volumes (not sold separately)
1382 pages
6 x 9
97 tables
394 illus.
\$20.00

9 big chapters give full coverage

1. Fundamental Concepts and Relations of Currents and Electromagnetic Fields
2. Space Electromagnetic Fields of Elementary Electric and Magnetic Dipoles
3. Fundamental Methods Used in Electromagnetic Theory
4. Propagation Characteristics
5. Transmission Lines and Radiation
6. Unobstructed Space Radiation
7. Space Radiation in the Presence of Electromagnetic Obstructions
8. Electromagnetic Diffraction
9. Wave Guides and Cavities

PAY ON EASY TERMS
SEE IT TEN DAYS FREE

McGRAW-HILL BOOK CO., INC.
330 West 42nd St., NYC 36

Send me Hund's SHORT-WAVE RADIATION PHENOMENA for 10 days' examination on approval. In 10 days I will remit \$5.00 (plus a few cents for delivery) and \$5.00 monthly until \$20.00 is paid; or I will return the books postpaid. (We pay for delivery if you remit first installment with this coupon; same return privilege.)

(Print) Name.....

Address.....

City..... Zone..... State.....

Company.....

Position..... L-2-52

This offer applies to U. S. only

ELECTRONIC GLASS WORKING EQUIPMENT for RADIO, TELEVISION TUBES, INCANDESCENT LAMPS, GLASS LATHES for TELEVISION TUBE REPAIR. We make Transformers, Spot and Wire Butt Welders, Wire Cutting Machines and 500 other items, indispensable in your production. Eisler Engineers are constantly developing New Equipment. If you prefer your own designs, let us build them for you. Write to Charles Eisler who has served The Industry over 30 years.

RADIO TUBE BULB STRETCHING MACHINE 12-POSITION EISLER TYPE

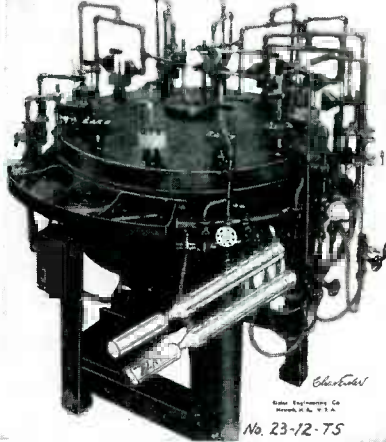

Machines for small Radio Tubes of all kinds; 24-Head Stem, 24-Head Sealing and 24-Head Exhaust Machines, Spot Welders, etc.

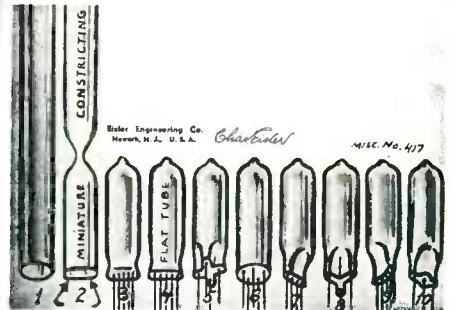

EISLER ENGINEERING CO., Inc.

751 So. 13th St.
Newark 3, N. J.

NEED SPECIFIC COILS?

BE SPECIFIC . . . CALL **DANO!**

- Form Wound
- Paper Section
- Acetate Bobbin
- Molded Coils
- Bakelite Bobbin
- Cotton Interweave
- Coils for High Temperature Applications

ALSO,
TRANSFORMERS
MADE TO ORDER

From simple electrical coil winding to specially treated coils, Dano can supply the exact coils you need to do your exact job. That's why experienced engineers with an eye toward uninterrupted production specify Dano coils.



THE DANO ELECTRIC CO.
MAIN ST., WINSTED, CONN.

Quartz Crystals

Made to your specific specifications. Accurate to the minutest tolerance. Exacting in performance—with thorough dependability.

Whether one or a million, you get prompt shipment. Made by craftsmen with a quarter century experience.

Send us detailed description and quantity for prices.

MICHAEL STAHL, Inc.

215 Fulton Street New York 7, N. Y.



Who pays your company's advertising bill ?

PEOPLE WHO REGARD advertising as an economic waste are fond of pointing out that it's the *customer* who pays the bill.

And they are right.

The customer also pays for your power supply, your production tools, your plant maintenance, your salaries. All these are figured into the price of your product, along with the cost of your advertising.

Does this mean that the customer pays *more* for your product because it is advertised? Not at all. No more than he pays anything "extra" for the machinery on your production line!

The truth is, your production tools enable you to *reduce* your manufacturing cost-per-unit — and hence your price to the customer.

Advertising works the same way. For it is simply the application of assembly-line methods to the *manufacture of a sale*.

How can selling be mechanized? Just consider the five basic steps —

1. Seeking out prospects
2. Arousing their interest
3. Creating a preference for your product
4. Making a specific proposal
5. Closing the order

Advertising performs the first three

of these jobs. And it performs them *far more economically* than any other means, leaving your salesmen free to concentrate their valuable time on the two jobs they alone can do, and do best.

As with any other capital investment, the yield from advertising depends on how *efficiently* it is put to work. But this much you can be sure of: nowhere does advertising work more efficiently than in business papers, with their tremendous concentration of hand-picked readers. Nowhere will your advertising dollar go so far toward reducing the cost of *manufacturing a sale!*



THE ASSOCIATED BUSINESS PAPERS
205 East 42nd Street, New York 17, N. Y.

RCA takes its ENVIRONMENTAL TEST PROBLEMS to *Tenney*



QUESTION

How is a jet fighter's transmitter affected by a screaming climb to the thin cold of 65,000 feet?

QUESTION

What is the useful life of a walkie-talkie in the steaming heat of the South Pacific jungle?

The answers to these and thousands of other questions will be worked out by RCA Engineers from test data obtained in an atmospheric test chamber designed and built by Tenney Engineering, Inc. This 50-ton chamber has been installed for the RCA Engineering Products Department, Camden, N. J., for environmental testing of both military and civilian electronic equipment.

Here, in one room can be simulated any and all conditions of temperature, humidity, and pressure found on earth or above it—to altitudes of 100,000 feet!

SPECIFICATIONS

Altitudes:	70,000 feet rated 100,000 feet practical ceiling
Humidity:	10% to 95%
Temperature:	-85°F. to +185°F.
Dimensions:	18'w x 28'd x 14'h
Refrigeration requirements:	180 hp

For all types of testing—development, research, environment, specification, and production—a Tenney-engineered chamber will insure dependability and precisely controlled test data for your requirements.

For full information on any environmental test equipment, write Tenney Engineering, Inc., Dept. A 26 Avenue G, Newark 5, N. J.

®RCA monogram reg. U. S. Pat. Office Radio Corp. of America

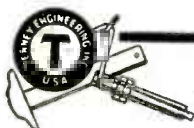

Tenney

⊕ 8209

Engineers and Manufacturers of Automatic Temperature, Humidity, and Pressure Control Equipment



Modified soldering-iron used for soldering feed-through terminals to chassis

invisible cracks. With infrared heat, glass and metal are heated and expanded uniformly. The lamp is mounted about 2½ in. above the work.

When metal-to-glass terminals are to be soldered to a large heat-absorbing piece of metal such as a chassis, infrared heat is not sufficiently localized. For this kind of work the tip of a soldering iron was cut off and drilled to the same size as the metal flange on the terminal. The terminal is placed over a solder preform on the chassis, and the iron is held over the flange to fuse the solder without applying heat directly to the ceramic or glass insulator.

Both techniques are in use at the Television Transmitter Division of Allen B. DuMont Labs., Inc., Clifton, N. J.

Special Iron Solders Tube Base Pins

A RESISTANCE soldering iron using spring-loaded V-shaped carbon electrodes speeds up the operation of connecting the eight leads of a tiny pulse transformer to the eight pins of an octal tube base into which the transformer fits. The ends of the tool spread to go around an indi-

All Band, Direct Reading

SPECTRUM ANALYZER

10 MC to 21,000 MC

The Model LSA is the result of years of research and development. It provides a simple and direct means of rapid and accurate measurement and spectral display of an rf signal.

Outstanding Features:

- Continuous tuning.
- One tuning control.
- 5 KC resolution at all frequencies.
- 250 KC to 25 MC display at all frequencies.
- Tuning dial frequency accuracy 1 percent.
- No Klystron modes to set.
- Broadband attenuators supplied from 1 to 12 KMC.
- Frequency marker for measuring differences 0-25 MC.
- Only three tuning units required to cover entire range.
- Microwave components use latest design non-contacting shorts for long mechanical life.
- Maximum frequency coverage per dollar invested.
- 5 inch CRT display.

Model LSA

The instrument consists of the following units:

Model LTU-1 RF Tuning Unit—10 to 1000 MC.

Model LTU-2 RF Tuning Unit—940 to 4500 MC.

Model LTU-3 RF Tuning Unit—4460 to 16,520 MC.

Model LTU-4 RF Tuning Unit—15,000 to 21,000 MC.

Model LDU-1 Spectrum Display Unit.

Model LPU-1 Power Unit.

Model LKU-1 Klystron Power Unit.



Polarad

PRECISION LABORATORY INSTRUMENTS

BROAD BAND MICROWAVE ATTENUATOR

Model SIJ

4 kmc to 12.4 kmc

Polarad's Broad Band Microwave Attenuator is intended for use as an external attenuator in microwave measurements with signal sources, receivers and for power measurements. Its useful frequency range is from 4000 mc to 12,400 mc. Model SIJ can be used as a standard calibrated attenuator or to couple a small amount of energy from a high level source for circuit protection, or for monitoring and for measurement purposes without introducing discontinuities or to insure rf circuit isolation.

By its use a Polarad Microwave Signal Source or a laboratory oscillator is converted into a signal generator.

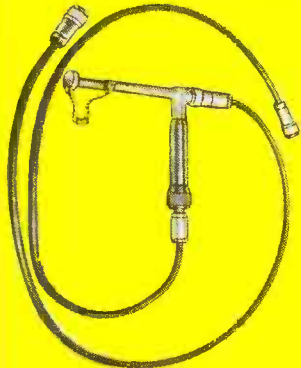

Features:

- Continuously variable attenuation.
- Stub tuned 50 ohm impedance.
- Waveguide beyond cut-off attenuator.

WIDE BAND VIDEO AMPLIFIER

Model VT 10 CPS to 20 MC

Designed for use as an oscilloscope deflection amplifier for the measurement and viewing of pulses of short duration and rise time. Excellent for TV, both black and white and color applications.

Features:

- Flat frequency response from 10 cps to 20 mc ± 1.5 db.
- Uniform time delay of 0.2 microseconds.
- Gain of 50 db.
- Frequency compensated high impedance attenuator calibrated in 10 db steps from 0-50.
- Fine attenuator covers a 10 db range.
- Phase linear with frequency over entire band.



Model VT

MICROWAVE SIGNAL SOURCES

Models SSR, SSL, SSS, SSM, SSX
634 MC to 11,000 MC

For use as a reliable source of microwave energy in trans-

mission loss measurements, standing wave determination, etc. Unidial Control for accuracy and ease of operation. Direct reading (no mode charts to consult). Frequency determination accurate to 1% through use of present calibration and temperature compensated klystrons.

Five Microwave Signal Sources are available to cover the frequency range from 634 MC to 11,000 MC. Units ruggedly constructed, mounted on aluminum castings to insure mechanical stability. Klystron reflector voltage automatically tracked with tuning of the klystron cavity to provide unidial control. Signal sources supplied complete with klystron.



FREQUENCY MARKER

Model FM-L

950 mc to 2,040 mc

Polarad's Frequency Marker, Model FM-L, provides accurate frequency determination to within 10 kc over the frequency range 940 to 2020 mc.

The Frequency Marker produces calibration signals at precisely determined frequencies and these signals may be displayed and compared with an unknown rf signal, whose frequency can then be accurately measured.

Features:

- Frequency standard accurate to one part in 10⁶.
- Frequency determination accurate to ± 10 kc.
- Ten mc, 1 mc, and interpolation markers available.
- Markers throughout entire frequency range, 940 mc to 2040 mc.

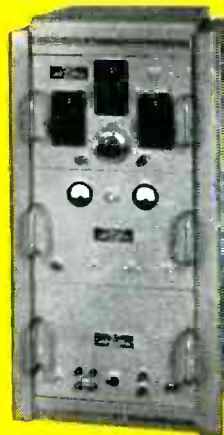

100 METROPOLITAN AVE., BROOKLYN 11, N. Y. • STagg 2-3464



SAVE YOUR RESEARCH TIME AND DOLLARS

With a Magnecord tape recorder you can make your industrial research more efficient! A precision recording instrument, the Magneorder becomes an "audio notebook" to record sound data of actual product test and development. Built for experts, this equipment saves expensive engineering hours in the laboratory or in the field.

Used by more engineers than all other professional recorders combined, Magnecoders record with greater fidelity and precision.

Magnecord, INC.
HIGH FIDELITY TAPE RECORDERS FOR INDUSTRY

NOISE ANALYSIS • PROCESS CONTROL
• VIBRATION TESTS • TELE-METERING

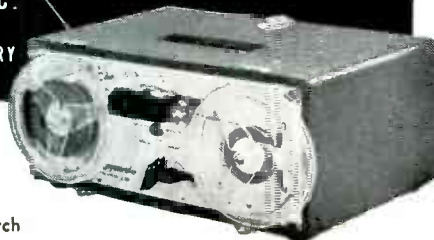

Write for NEW CATALOG
MAGNECORD, INC., DEPT. EA-2
360 N. Michigan Avenue, Chicago 1, Illinois
Send me further information on Magnecord
tape recording for industrial "Sound" Research

Name.....
Company.....
Address.....
City.....Zone.....State.....



Resistance soldering tool gives cleaner soldered pins

vidual pin, heating it enough so that solder applied to the open end of the pin runs down inside. With this technique, used at DuMont's Television Transmitter Division in Clifton, N. J., a perfect half-spherical globule of solder is easily achieved on the end of each pin, and no solder runs down the sides of the pins.

Picture-Tube Carton

A RADICALLY new design of corrugated shipping carton for glass or metal picture tubes gives a solid stackable box that can be inexpensively glue-sealed. The inner support is fabricated as a box and then twisted into an hour-glass shape by hand to provide support for the funnel of the tube. This inner construction braces the outer box.

The new tube package was de-

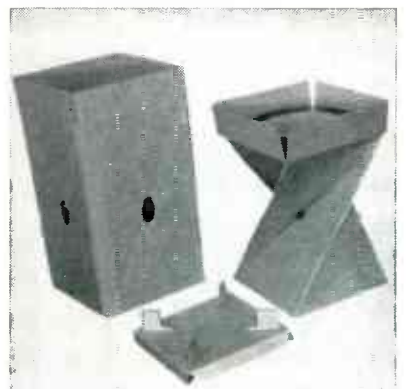

New picture-tube carton converts from box to hour-glass shape by twisting

A NEW Insulating Laminate...

INSUROK* GRADE T-812

COMBINES:

- SUPERLATIVE INSULATION RESISTANCE
- LOW MOISTURE ABSORPTION
- VERY HIGH STRENGTH
- EXCELLENT PUNCHABILITY

*Reg. U. S. Pat. Off.

INSUROK T-812 is a new paper-base punching stock that laughs at heat and humidity! It has outstanding properties that have never before been combined in one insulating laminate. T-812 has excellent electrical characteristics, plus a spectacular ability to retain them through extremes of heat and humidity. Its insulation resistance after humidity conditioning is particularly noteworthy.

INSUROK T-812 retains all of the properties of the well-known INSUROK T-725 and, in addition, has lower moisture absorption and much higher insulation resistance. It punches readily into intricate shapes. Investigate INSUROK T-812 for your product. Information upon request.

T-812's Property Combination —Unmatched by any other material!

Thickness tested.....	1/16"	
Moisture Absorption (24 hours).....	0.38%	
Expansion after 24 hours' immersion in water at 77°F. Center	0.0001"	Edge..... 0.0002"
Tensile Strength, psi.....	Main Direction..... 19,500	Cross Direction..... 14,500
Flexural Strength, psi.....	Main Direction..... 23,000	Cross Direction..... 18,000
Dielectric Strength (perpendicular to laminations) V/Mil, Short Time.....	725	Step by Step..... 625
	Tests at Room Conditions	After 96 hrs. at 90% Rel. Hum. at 104°F.
Power Factor at 1 megacycle.....	0.028	0.030
Dielectric Constant at 1 megacycle	4.4	4.5
Loss Factor at 1 megacycle	0.13	0.14
Insulation Resistance, megohms		1,000,000

The RICHARDSON COMPANY

FOUNDED 1858—LOCKLAND, OHIO

2797 Lake St., Melrose Park, Illinois (Chicago District)

SALES OFFICES: CLEVELAND • DETROIT
INDIANAPOLIS • LOCKLAND, OHIO • MILWAU-
KEE • NEW BRUNSWICK, (N. J.) • NEW YORK
PHILADELPHIA • ROCHESTER • SAN FRANCISCO
ST. LOUIS

NO OTHER CAPACITOR
GIVES YOU MORE

Can't Melt
even under the
heat of the
soldering iron



NO OTHER CAPACITOR
SELLS FOR LESS

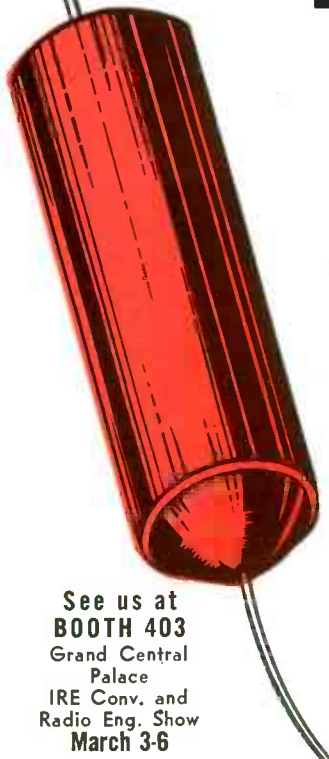

DUMONT

*Perfectly Centered
Completely Molded*

CAPACITOR

Meets all RMA specifications
for TV manufacturers

- ★ Exclusive Dumont Process guarantees the section of each capacitor to be perfectly centered
- ★ Very high humidity resistance
- ★ Easier to work with — no wax to run off
- ★ Mineral oil impregnant provides greatly increased life. Should a weak spot develop, mineral oil reaches in to fill it thus maintaining peak efficiency over an extended period. Available also with wax impregnant

Write for Data Sheet

**DUMONT
ELECTRIC CORP.**

308 Dyckman Street
New York 34, N. Y.

See us at
BOOTH 403
Grand Central
Palace
IRE Conv. and
Radio Eng. Show
March 3-6

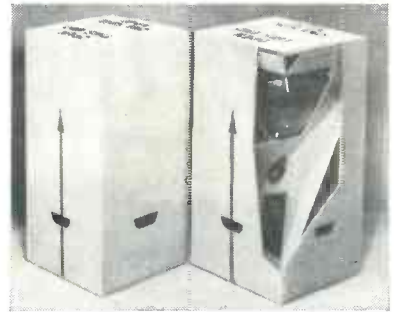

Sealed carton, and cutaway view showing how tube is suspended so it cannot be damaged by careless handling. In shipment, face of tube is down and resting on reinforced pad

veloped by Richard E. Paige Inc. of New York City. Electrical and Musical Industries, English manufacturer, has adopted the box.

Miniature-Tube Inserter

To REST weary thumbs of operators who insert miniature tubes all day long in sets coming down the line at the rate of three a minute, methods engineers at Emerson's Jersey City plant devised a tube holder from brass tubing and wood. Several slits were sawed in the end of the brass tube to get springiness, and additional phosphor bronze strips were fastened inside to grip the miniature tubes. The holder is intended only for occasional use, as operators work faster without the tool.



Inserting miniature tube in socket with holder. Punched-up flanges in chassis, on opposite sides of socket holes, cost little more than plain socket holes yet serve to hold tubes upright in socket and provide grounding supports for shields



BRIDGEPORT BRASS COMPANY

COPPER ALLOY BULLETIN

"Bridgeport" MILLS IN BRIDGEPORT, CONN. AND INDIANAPOLIS, IND.—IN CANADA: NORANDA COPPER AND BRASS LIMITED, MONTREAL



Small Screw Machine Products—Courtesy Milford Manufacturing Co., Milford, Conn.

Making Small Screw Machine Parts from Brass

Small screw machine parts come in an endless variety of shapes and applications. Being small, close tolerances are necessary. Each job presents a special problem of manufacture and requires a lot of ingenuity and know-how.

Essentials for Quality Control

Long runs are necessary for profitable operation in order to absorb the cost of working out a job to meet customers' requirements for quality, speed of production and price per thousand. To meet the above the following should be observed:

1. The brass rod must have the correct composition and physical properties and must be uniform in diameter, machinability and temper.
2. Machines must be kept in tiptop condition—not worn or sloppy. You cannot operate profitably with worn-out machines.
3. Sharp tools, correctly ground are essential. They should be kept ahead of the job so that replacements can be made before they become too dull.

Dull tools destroy finish, produce burrs, and slow down the operation.

On long runs carbide tools, despite their higher costs as compared to high speed steel, generally prove most economical.

4. Coolant-lubricant must be ample and well directed to keep tools and work cool. Light mineral oils are still popular for brass and most other metals although many operators prefer soluble oils.

How Samples Were Made

Most of the samples illustrated above were made on OO-G Brown and Sharpe machines although some operators prefer Swiss machines for the extremely small parts. The outside threads and knurls are rolled on the machine. Straight flute taps are used for shallow holes. Deep internal threads are made with a tap with spiral flutes to remove the shavings more readily. Ledrite 6 — Standard (approximately 61% copper, 3.4% lead, remainder zinc) free cutting brass rod gives excellent results for this type of work.

Phosphor Bronze and Brass Give Long Life to Snap-Action Switches

Because they are subjected to constant use on coin-operated vending machines, record changers, washing machines and many kinds of aviation, automotive, industrial and marine controls, dependable snap-action performance is of utmost importance in switches such as that pictured below.

On this switch, the brackets and actuators are of .032 inch brass, the contact is made of $\frac{1}{8}$ inch diameter silver, and the other material used is .012 inch phosphor bronze. The excellent spring properties of phosphor bronze are retained under repeated flexing, making it an ideal material for this application. It resists fatigue and wear from rubbing against other materials, and has excellent arc resistance.

All parts are made to close tolerances, so that the operating and release points do not exceed plus or minus .025 inches of nominal.

The precision fabrication and assembly, plus the use of high-quality materials, enable these switches to achieve exceptionally long service life.

Tests have shown the following results:

125 volts A.C.: 1 amp—2.5 million operations

125 volts A.C.: 3 amp—2.0 million

125 volts A.C.: 5 amp—1.7 million

125 volts A.C.: 6 amp—1.5 million

These tests were made at 6 cycles per minute, 20% over travel, resistive load.

(7864)

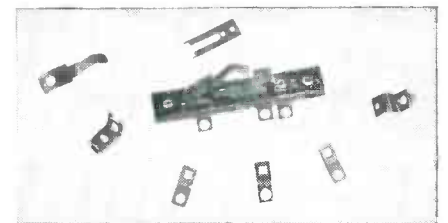

The blade of the snap-action switch is made from .012 inch phosphor bronze. Other parts are of .032 inch brass. Photo courtesy Cherry-Channer, Highland Park, Ill.

NEW PRODUCTS

Edited by WILLIAM P. O'BRIEN

Instruments For Measurement And Control Stand Out . . . Equipment For Research And Development Is Also Featured . . . Thirty-Nine Manufacturers' Catalogs Contain Much Engineering Data

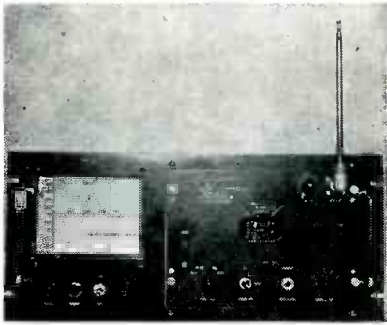

VHF Meter

GERTSCH PRODUCTS, INC., Los Angeles, Calif., is now producing the new direct-reading model FM-1A vhf meter. Frequency range is 20 to 480 mc; and power supply is PS-L/FM-1A regulated power supply to provide proper voltage with line voltage variations from 105 to 125 v. Provision is made to modulate the carrier frequency at a minimum of 30 percent at 1,000 cycles. The FM-1A employs a unique and original circuit utilizing an extremely accurate 1.0-mc crystal, with variable capacitance trimming to allow exact adjustment. All frequency measurements are referred to the crystal, which has a temperature coefficient of 0.0001 percent per deg C.

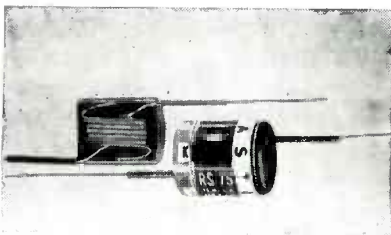

Molded-In Selenium Rectifiers

ELECTRONIC DEVICES INC., 429-12th St., Brooklyn, N. Y. All ratings up to 200 ma d-c output in the Plastisel line of miniature electronic selenium rectifiers are molded-in

similar to small tubular capacitors. The outer case is spiral-wound phenolic wax which is rock hard at 100 C. The excellent thermal conductivity of this wax and the low loss plates compensate adequately for the loss of cooling due to molding in. These rectifiers are manufactured with bare or insulated tin-copper leads. In ratings from 250 to 500 ma d-c the standard open-plate construction is used. However, the high-efficiency plates lead to cooler operation and resultant longer life. All Plastisel rectifiers are guaranteed for 1,000 hours or 1 year, whichever occurs first.



Laboratory Amplifier

HERMON HOSMER SCOTT, INC., 385 Putnam Ave., Cambridge 39, Mass. The relay-rack type 221-A laboratory amplifier features extended frequency response, high power output and negligible hum and distortion. Specifications are: rated power output, 20 w; frequency response flat from 12,000 to 55,000 cycles with controlled cutoff characteristics beyond for maximum stability and freedom from spurious oscillation and distortion; first-order difference-tone intermodulation component less than 0.1 percent at full-rated peak output; harmonic distortion less than 0.5

percent at full 20 watts output; hum level -90 db below full output; input for full rated 20-watt output, 0.5 v on low level input, 1.5 v on high level input; input impedance 0.5 megohm for low level and 1.5 megohms for high level input.

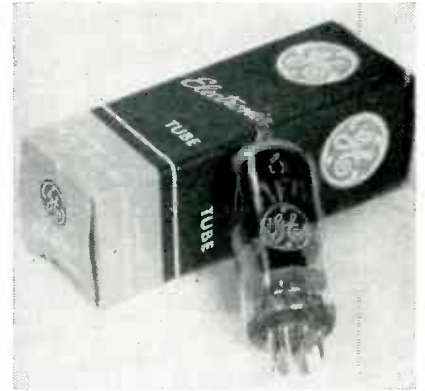

UHF Receiving Tube

GENERAL ELECTRIC Co., Schenectady, N. Y., has begun production of the 6AF4, a miniature receiving tube for use in uhf reception. A seven-pin triode, it is designed for use as a local oscillator for the new uhf channels from 470 to 890 mc. Other characteristics are: plate voltage, 150 v; plate current, 28 ma; plate input, 2.5 w; plate dissipation, 2.25 w; heater voltage, 6.3 v; and heater current, 225 ma.



Pulsed Carrier Generator

KAY ELECTRIC Co., Pine Brook, N. J. offers a pulsed carrier generator, the Rada-Pulser, designed to give rapid and accurate transient response information in laboratories, on production lines and in the field. Specifications are as follows: carrier frequencies, 30 mc and 60 mc; pulse widths, 0.1 and

NEVER ASLEEP AT THE SWITCH



THE RAYTHEON 6AN5 MINIATURE PENTODE For Computer Applications

The Raytheon 6AN5 was the first of its kind — the first with low interface resistance to avoid "sleeping sickness". It remains the first choice of designers of dependable, long lived computing devices.

The Raytheon 6AN5 has been in continuous production for over two years. This means maximum reliability, minimum failures.

Important characteristics of the 6AN5 drop less than 10% in 5000 hours *under on, off, or flip-flop conditions.*

The Raytheon 6AN5, providing high efficiency with low plate voltage is also recommended for such services as

- Video Output Amplifier*
- Wide Band RF Amplifier*
- Wide Band IF Amplifier*
- RF Class C. Amplifier*
- Class C. Frequency Multiplier*

**NOW AVAILABLE FOR
IMMEDIATE DELIVERY**

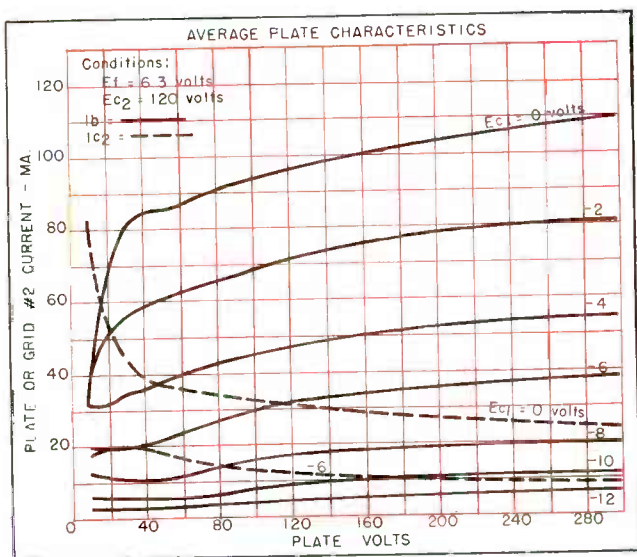

Write for data sheets which contain complete information on this and many other Raytheon Special Purpose Miniature and Subminiature Tubes.



RAYTHEON MANUFACTURING COMPANY

Receiving Tube Division

Newton, Mass., Chicago, Ill., Atlanta, Ga., Los Angeles, Calif.

RELIABLE SUBMINIATURE AND MINIATURE TUBES • GERMANIUM DIODES AND TRANSISTORS • RADIAC TUBES • RECEIVING AND PICTURE TUBES • MICROWAVE TUBES

Excellence in Electronics

0.25 μ sec; pulse repetition rate, continuously variable from 500 to 2,000 pps; maximum r-f output, approximately 1 volt at 70 ohms; attenuators, 20 db, 20 db and 10 db switched 10 db continuously variable. Pulse output is 50 v at 70 ohms. Price is \$595.00.



D-C Breaker Amplifier

LITTON-BECKER INSTRUMENT CO., INC., 20 Beckley Ave., Stamford, Conn. Model 14 ultrasensitive d-c breaker amplifier can be furnished for operation with input circuits between 5 and 100,000 ohms. It has a noise level which closely approaches the limits imposed by thermal agitation and has a zero stability of 0.005 μ v per day. This amplifier can be employed in circuits which formerly used highly sensitive suspension galvanometers. It has the advantages of fast speed, output suitable for recording and flexibility of sensitivity and controls. Price is \$665.

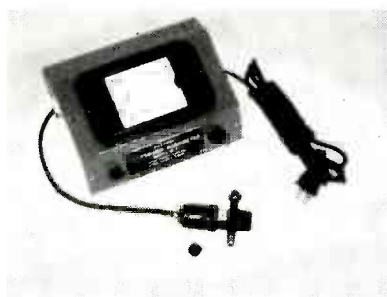

Manometer and Flowmeter

HASTINGS INSTRUMENT CO., INC., Super Highway and Pine Ave., Hampton 10, Va., has announced a highly sensitive electronic manometer and flowmeter having no glass or plastic tubes and containing no fluids. The manometer operates from a noble metal thermopile us-

ing the same principles which the company has applied to its vacuum and air-velocity measuring instruments. To operate, the two taps on the gage tube are simply connected to the two points at which the pressure difference is to be measured. To use the instrument as a flowmeter, the tube is placed directly in the line for flow rates or connected to pressure taps on two sides of a calibrated orifice for high flow rates. The manometer will measure extremely low pressure differences and has a dual range of 0.001 in. to 0.1 in. and 0.1 in. to 2 in. water. The instrument may be used for direct indications or attached to a recorder. It operates on 110-v, 60-cycle a-c. A constant voltage transformer is available to eliminate any effects from variation in the line voltage.

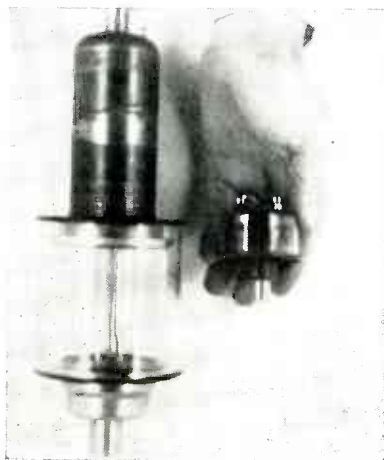

Oil-Immersed Rectifier Tubes

WESTINGHOUSE ELECTRIC CORP., 306 Fourth Ave., Pittsburgh 30, Pa. Two high-voltage oil-immersed rectifier tubes set new standards of compactness. One is a 40-kv peak-inverse-voltage tube capable of 150 ma average and 900 ma peak current, but it is only about the size of a tennis ball. It is oil immersed, which is desirable not only to keep the size down but also to maintain the voltage breakdown strength and to reduce the effect of rapid temperature and pressure changes when carried aloft as part of a radar set. The second rectifier, of similar construction, provides 125-kv (peak inverse) for heavy-dust precipitation equipment. It is rated at 300

ma average and 1 ampere peak, but is only 11½ in. long, and the tube portion only 4 in. in diameter. It is only about one-tenth as large as the air-cooled variety.



Automatic Temperature Control

THE LAWRENCE INSTRUMENT CO., 4903 Twelfth Ave., Brooklyn 19, N. Y. The Firelator electro-mechanical automatic temperature control unit is manufactured in three standard ranges up to 2,250 F and one special range up to 3,000 F. It combines the features of an automatic limit control and automatic temperature maintenance control in one unit. It is designed to operate as a plug-in unit and may be used to control any electrical furnace. Unaffected by voltage surges, it will operate from 70 v a-c to 140 v a-c without requiring any adjustment. Control is achieved by use of a thermocouple, pyromillivolt meter and an adjustable photocell bridge.



Servo Amplifiers

INDUSTRIAL CONTROL CO., Wyandanch, L. I., N. Y. The 421-A and 423-A are universal, 400-cycle servo amplifiers designed to drive two-phase servo motors requiring 6 and 9 watts per phase respectively. They feature independent, screw-driver

Now in **MASS PRODUCTION...**

**PYRAMID ULTRA-COMPACT
metallized
paper capacitors**

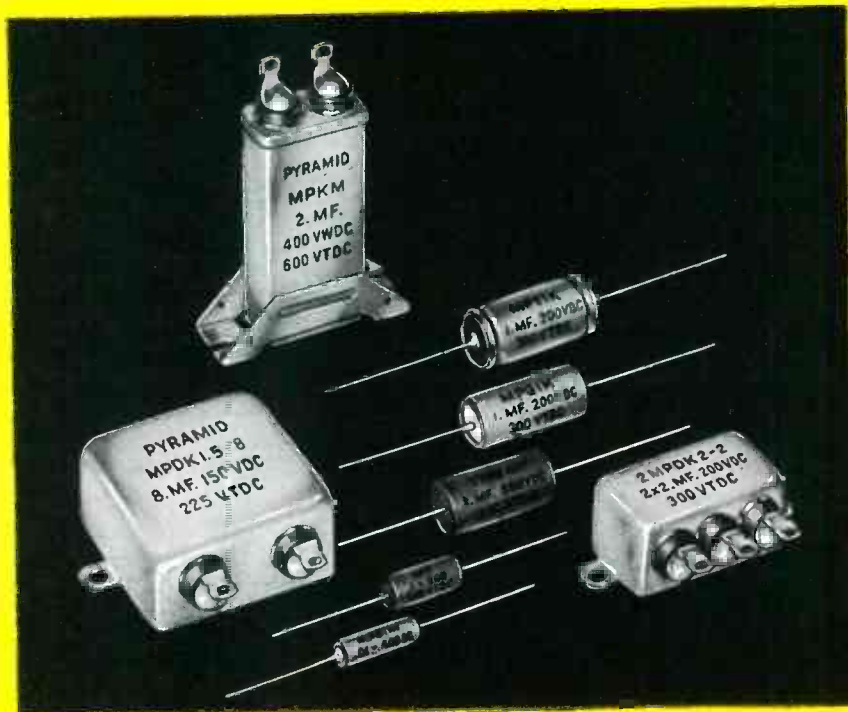

PYRAMID Series M CAPACITORS use a specially-prepared metallized paper, providing all-important savings in size and weight... Pyramid now produces large quantities of these capacitors in a wide variety of cardboard or hermetically sealed metal containers.

Your letter-head inquiries are invited



PYRAMID ELECTRIC COMPANY • 1445 HUDSON BLVD., North Bergen, N. J.

**NOW...9000 records
per minute!**
with the NEW POTTER high speed
**TELEDELTA
RECORDER**

**IMMEDIATELY VISIBLE
INSTANTANEOUS
PERMANENT
DIGITAL**

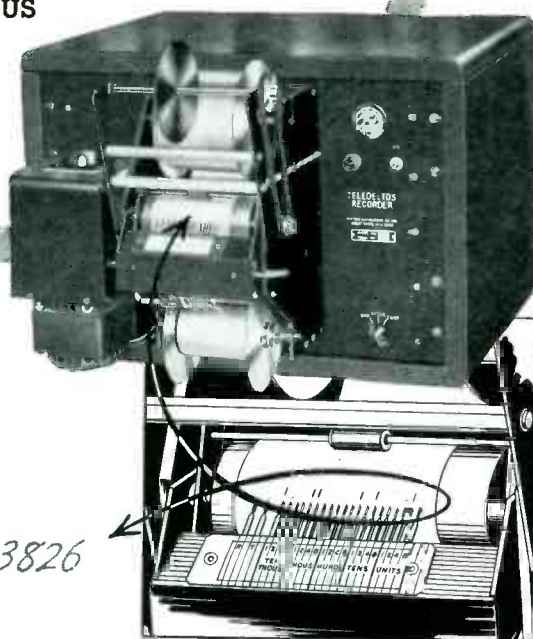

Designed to record measurements obtained on Potter Electronic counters, scalars, chronographs and frequency-time counters.

The Potter Instrument Co. High Speed Teledelta Recorder provides a permanent recording of digital information at rates up to 150 six-digit answers per second. The measurements are transferred to electrically sensitive paper using four styli for each digit arranged in the famous Potter (1-2-4-8) read-out. The records are indexed intermittently and controlled by the events being measured.

Write for information on specific applications to Dept. 6J.

**POTTER RECORDING
COUNTER CHRONOGRAPH**

Measures time intervals up to 0.10000 second in increments of 2.5 microseconds. (Higher resolutions are also available.)

Applicable to projectile velocity measurements, frequency measurements, geophysical measurements, telemetering and wherever micro-second timing is required.



NEW PRODUCTS

(continued)

controls on damping, gain and carrier phase, and thus can be stocked for use in all servo loops requiring their respective servo motors. Other characteristics are: maximum gain, 1,000; phase adjustable through 160 deg; internal pickup below 2 mv; damping adjustable over wide range. By using these units together with breadboard mechanical apparatus, a servo loop can be set up in the few hours required to design and construct an interconnecting harness.



Volume Level Indicator

THE DAVEN Co., 191 Central Ave., Newark 4, N. J. The improved series 911 portable volume level indicator is designed to indicate audio levels in broadcasting, sound recordings and allied fields where precise monitoring is important. The unit is completely self-contained, requiring no batteries or external power supply. The indicating meter is a copper-oxide type instrument possessing ideal characteristics for monitoring purposes. The adjustment is such that the pointer will indicate 99-percent normal deflection at zero vu in approximately 0.3 second. Overswing is not more than 1 to 1.5 percent. Meter scale is calibrated in vu and percent.

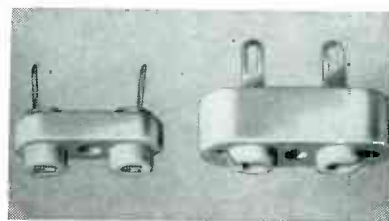

Crystal Sockets

UNITED STATES GASKET Co., Fluorocarbon Products Div., Camden 1, N. J., is offering a new line of crystal sockets designed for use where

POTTER INSTRUMENT COMPANY

INCORPORATED
115 CUTTER MILL ROAD, GREAT NECK, NEW YORK



Tested and approved

—FOR SAFETY AND DEPENDABILITY BEYOND SPECIFICATION

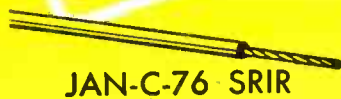

JAN-C-76 SRIR

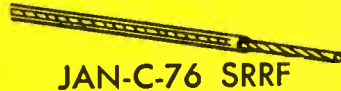

JAN-C-76 SRRF

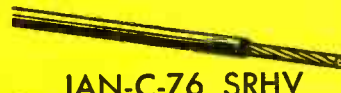

JAN-C-76 SRHV



JAN-C-76 WL



UL APPROVED 105°C



UL APPROVED 90°C

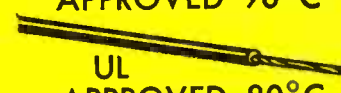

UL APPROVED 80°C



FLEXIBLE CORD



TV LEAD-IN WIRES



SHIELDED WIRES & CABLES



COAXIAL CABLE



INSTRUMENT WIRES



COMMUNICATION WIRES & CABLES

SPECIAL WIRES & CABLES TO SPECIFICATION



CHESTER

plasticord-plasticote

WIRES and CABLES

CHESTER makes them all!

- JAN-C-76 APPROVED WIRES
- 80°-90°-105°C HOOK-UP WIRE
- SHIELDED WIRE AND CABLE
- FLEXIBLE CORDS
- COAXIAL CABLE
- TELEVISION LEAD IN CABLE
- GAS TUBE HIGH TENSION CABLE
- OIL BURNER IGNITION CABLE
- BLASTING WIRE
- THERMOSTAT CABLE
- BELL AND OFFICE WIRE
- TW BUILDING AND FIXTURE WIRE

All Chester wire and cable features the extra dependability, long service life and easier working qualities of plastic insulation. Their tough, impervious plastic coats provide maximum immunity to abrasion, weather, oil and most chemicals. They are smooth, pull through conduit with minimum effort and present a fine appearance in exposed locations.

There's a Chester single or multi-conductor wire or cable for practically every indoor or outdoor requirement including many special constructions for the electrical, electronic, TV, radio, telephone and other industries. Why not write today for full information?

"Chester"
says—

Write today for your free copy of the Chester Wire and Cable catalog. A complete guide to plastic covered wire and cable for every electronic and electrical application. Please address inquiries on company letterhead.



CHESTER CABLE CORP.
C H E S T E R , N E W Y O R K

MANUFACTURERS OF QUALITY WIRE AND CABLE FOR EVERY ELECTRICAL AND ELECTRONIC REQUIREMENT

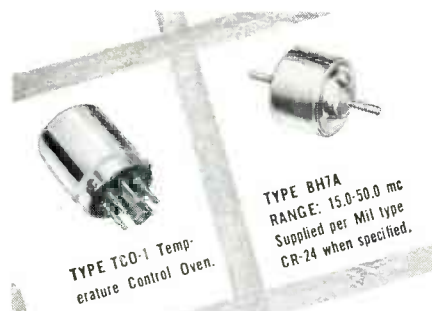

TYPE TCO-1 Temperature Control Oven.

TYPE BH7A RANGE: 15.0-50.0 mc Supplied per Mil type CR-24 when specified.

IT'S PRECISION

HIGH on the list of important reasons for selecting Bliley Crystals is precision. From research, thru development and production, this keynote is emphasized. Precision built Bliley Crystals are a must for the precision performance of your equipment.



TYPE BH6A RANGE: 1.4-75.0 mc Supplied per Mil type CR-18; CR-19; CR-23; CR-27; CR-28; CR-37; CR-33; CR-35; CR-36 when specified.

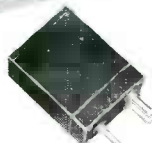

TYPE AR23W RANGE: 0.000 - 0.19999 mc Supplied per Mil type CR-15; CR-16; CR-29; CR-30 when specified.



TYPE SR5A RANGE: 2.0-15.0 mc Supplied per Mil type CR-1A when specified.

Bliley CRYSTALS

BLILEY ELECTRIC COMPANY
UNION STATION BUILDING
ERIE, PA.

extremely low losses and frequency stability are desired and mechanical shock and vibration are problems. Made of Teflon (tetrafluoroethylene resin), these Chemelec sockets have a loss factor of less than 0.0005 and a dielectric constant of only 2.0 from 60 cycles to 30,000 mc. Having zero water absorption rating, they are unaffected by extreme humidity. They are serviceable at temperatures from 110 F to 500 F with negligible change in critical electrical characteristics. The sockets are made in three sizes: for 0.050-in. pins spaced 0.500 in.; 0.095-in. pins spaced 1.500 in.; and 0.125-in. pins spaced 0.750 in.



Audio Amplifier

THE RADIO CRAFTSMEN, INC., 4401 N. Ravenswood Ave., Chicago 40, Ill. Model 500 ultrafidelity all-triode audio amplifier is based on the Williamson circuit. Total harmonic distortion is less than 0.1 percent at 10 watts at midfrequencies; intermodulation distortion, less than 0.5 percent at 10 watts; power response, 12 watts, ± 1 db, 10 to 50,000 cps; frequency response, ± 0.1 db, 20 to 20,000 cps and ± 2 db, 5 to 100,000 cps.

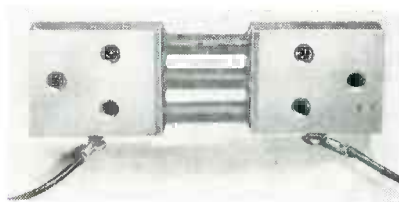

Switchboard Shunts

INDUSTRIAL RECTIFIER Co., 120 Cedar St., New York, N. Y., has introduced a new line of 50-mv switchboard shunts for d-c instruments, supplied with calibrated

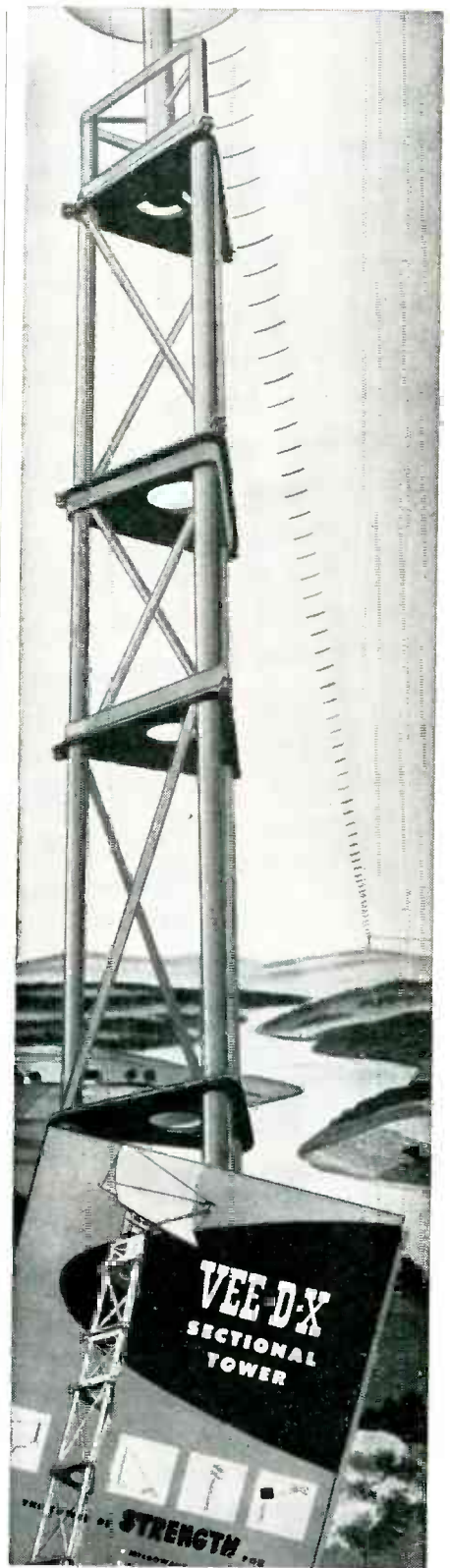

MOST ECONOMICAL TOWER

for MICROWAVE COMMUNICATIONS TV and FM RADAR

THE LAPOINTE-PLASCOMOLO CORPORATION
Windsor Locks, Connecticut

Save Assembly Time

with ready-to-use **Inmanco**[®]

INSULATION PARTS

♦ *Time-per-assembly* drops to record lows when Inmanco Insulation Parts are specified for electrical and electronic equipment, because Inmanco parts are fabricated with precision. They slip into place easily and snugly . . . no time wasted in struggling to fit inexact parts.

By manufacturing insulation parts with specialized high speed equipment on a production line basis, Inmanco produces fabricated parts with maximum economy. Designs are reproduced exactly by shearing, sawing, slitting, die cutting, creasing, forming, cuffing, or rotary cut molding.

You can be sure of the *specific* protection you need, too . . . because Inmanco parts are fabricated from such a wide variety of materials. *You can select* the dielectric strength, heat resistance, toughness, and other properties required for your application.

Inmanco engineers are always glad to show how fabricated parts can save time in the production of military and civilian electronic and electrical equipment . . . including motors, coils, controls, transformers and instruments. Get full information on ready-to-use Inmanco Insulators *now*.



Inmanco Parts Can Be Fabricated From These Insulation Materials

- All rag, part rag, wood pulp papers and press boards
- Varnished cambric-paper combinations
- Hard maple wood
- Laminated plastics
- Plastic films
- Plastic film-paper combinations
- Silicone resin coated glass cloth
- Vulcanized fibre and fishpaper
- Varnished asbestos, cambric, canvas, and glass cloths and paper



Ask For

FREE

literature on Inmanco fabricated electrical insulation parts, today.



Inmanco[®]

products are manufactured exclusively by Insulation Manufacturers Corporation

WHERE TO GET INMANCO FABRICATED INSULATORS INSULATION MANUFACTURERS CORPORATION

CHICAGO • CLEVELAND • DAYTON • MILWAUKEE • PITTSBURGH

Also represented by: H. R. Brethen, Detroit • H. A. Holden, Inc., Minneapolis • W. C. Johnson, Peoria, Ill.

ROBERT McKEOWN COMPANY
Newark, New Jersey

EARL B. BEACH COMPANY
Pittsburgh, Pa.

DIAMOND STATE FIBRE COMPANY OF CANADA, LIMITED
Toronto, Ont., Canada

INSULATION AND WIRES INCORPORATED

Adrian, Mich. • Atlanta • Boston • Detroit • Fort Worth • Houston • Kansas City, Kas.
Los Angeles • Memphis • Newark • Portland, Ore. • St. Louis • San Francisco

TIC-TALKS

FEATURE

Something new in Precision Potentiometers . . .

... the standardization of a Non-Linear Precision Potentiometer, the *type RVP3-S59 Sine-Cosine potentiometer*, one of the many types standard with the Technology Instrument Corporation, performs two operations in a single potentiometer assembly . . . two wipers spaced 90 degrees apart yield both sine and cosine outputs.

1. Total resistance: 20,000 ohms plus or minus 5 per cent between terminals 1 and 3.
2. Accuracy: Plus or minus .5 per cent of the peak to peak amplitude.
3. Maximum voltage: Conservatively rated as 80 volts between terminal 1 and 3.
4. Life: Guaranteed for at least 500,000 complete cycles in either direction at 30 rpm.
5. Potentiometer base: Precision machined aluminum (originated by TIC) finished with corrosion resistant black Alumilite.
6. All fixed connections are soldered.
7. Wipers: Paliney spring wiper with double contact, for positive electrical connection, long wear and light torque.
8. Resistance Element: Karma wire with temperature coefficient of .00002 parts per degree centigrade.
9. Slip Rings: Inlaid coin silver slip rings. Paliney contacts on dual brushes for positive connection and low contact resistance.
10. Full humidity protection with type 76-S fungus resistant varnish.
11. Units may be ganged, using TIC's patented "Constrict-O-Grip" clamp rings which permit precise phasing with amazing ease.

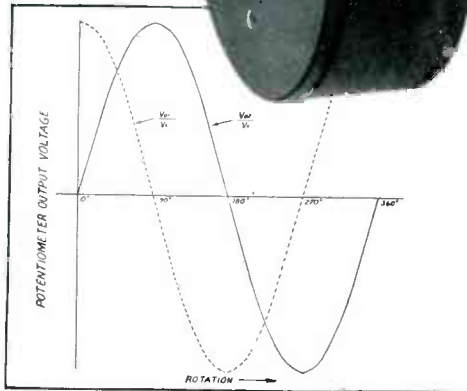
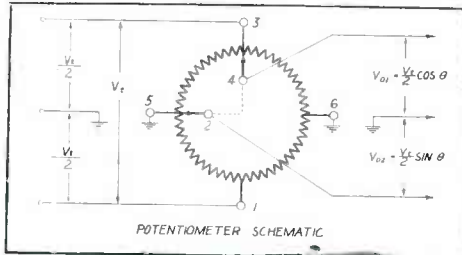

TIC standard potentiometers have the same built-in precision and craftsmanship normally found only in custom-built products. Research, engineering and design facilities for special constructions and non-linear or linear functions are an integral part of TIC services. Submit your potentiometer problem, whether the need is for standard or custom design.

Engineering Representatives

Cleveland, Ohio — PRespect 1-6171
Chicago, Ill. — UPtown 8-1141
Rochester, N. Y. — MonroE 3143
Canaan, Conn. — Canaan 649
Dayton, Ohio — Michigan 8721

Arn Prior, Ontario — Arn Prior 400
New York, N. Y. — MUrray Hill 8-5858
Cambridge, Mass. — ELior 4-1751
Hollywood, Cal. — HOLlywood 9-6305
Dallas, Texas — DLxon 9918

Technology Instrument Corp.

533 Main Street, Acton, Massachusetts, Telephone: Acton 600

10-ft leads and hardware, with current capacities of 100 to 3,000 amperes. These shunts are dipped in a special corrosion-resistant enamel and then sprayed with moisture and fungus-proof varnish.



Electric Soldering Tool

KELNOR MFG. CORP., 222 Kearny St., San Francisco, Calif. Model OS-7 precision light-weight electric soldering tool was specially designed for production lines. All nickel plated, it has a 125-watt improved heating element with simplified replacement assembly; more rugged one-piece construction to withstand hard industrial use; and improved all-ceramic insulation. Soldering temperature is reached in 48 seconds. The unit has a 3/16-in. extendable tip and weighs 10 oz. A descriptive catalog sheet and price list are available.



Audio Oscillator

GENERAL RADIO Co., 275 Massachusetts Ave., Cambridge 39, Mass. Type 1214-A unit oscillator is a simple two-frequency oscillator (400 and 1,000 cycles) useful as a modulating source for high-fre-

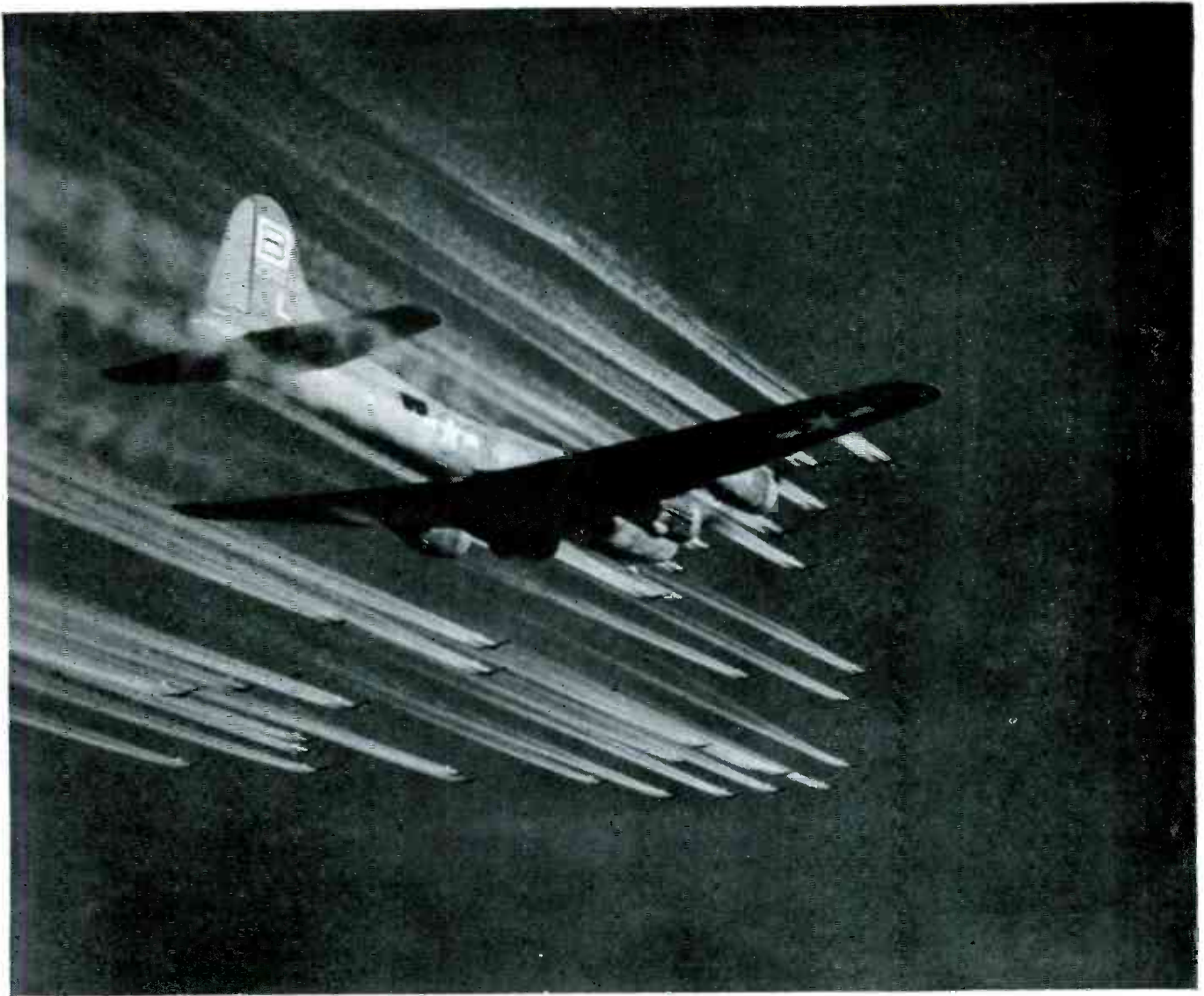

We hired an engineer over Berlin

"The Boeing Flying Forts came through a wall of flak and fighters that night to hit Berlin right on the nose. They never let us down—not then or on any of the raids to come. I was proud to fly the old Boeings. Now I'm prouder still to be on the great engineering team that designs the new ones."

Boeing engineers feel that way. And they'd be honored to have you join them as they pioneer in dramatic new fields of aviation. There are excellent openings in Seattle now for experienced and junior aeronautical, mechanical, electrical, electronics, civil, acoustical, weights and tooling engineers for design and research; for servo-mechanism designers and analysts; and for physicists and mathemati-

cians with advanced degrees. Or, if you prefer the Midwest, there are similar openings at the Boeing Wichita, Kansas, Plant. Inquiries indicating a preference for Wichita assignment will be referred to the Wichita Division.

The steady growth of Boeing's Engineering Division over the past 35 years is an index of stability. There's great work to be done in all phases of aircraft design . . . in the fascinating new field of guided missiles . . . in jet propulsion.

You'll find here some of the world's best research facilities and you'll work with men who have helped establish Boeing's world leadership in aviation research, design and engineering. You'll like the pay, too. It's good and it grows

with you. Moving and travel expense allowance is provided.

Be a Boeing man. No other name in aviation will loom larger in importance during the years to come.

Write today to the address below, or use the convenient coupon.

JOHN C. SANDERS, Staff Engineer—Personnel
Dept. H-2
Boeing Airplane Company, Seattle 14, Wash.
 Engineering opportunities at Boeing interest me. Please send me further information.

Name _____

Address _____

City and State _____

BOEING

DIRECT COUPLED WIDE BAND

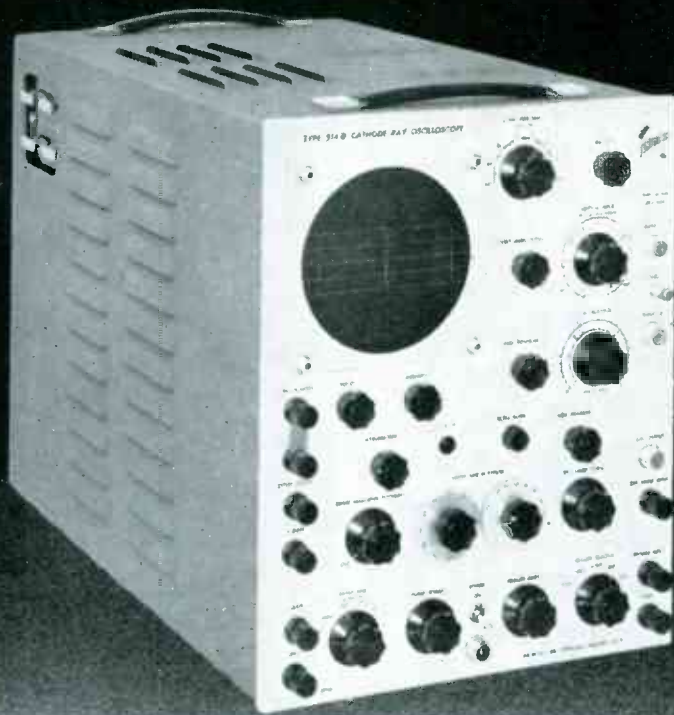

TEKTRONIX TYPE 514-D

- DC to 10mc bandwidth, .04 μ sec rise time
- Smooth transient response
- 3-section distributed-type output stage
- Continuously-variable deflection sensitivity, .03v/cm to 100 v/cm ac, .3v/cm to 100v/cm dc
- .25 μ sec signal delay
- Calibrating voltage—1kc square wave, 0 to 50v in seven ranges, accuracy 2% of full scale
- Sweep—triggered or recurrent as desired, continuously-variable, .01 sec/cm to .1 μ sec/cm. Calibration accuracy 5%
- 5X sweep magnifier
- All dc voltages electronically regulated
- Many other useful features
- Tektronix Type 514-D Cathode-Ray Oscilloscope — \$950.00 f.o.b. Portland, Oregon

COMPLETE SPECIFICATIONS ON REQUEST

TEKTRONIX, Inc.

P. O. Box 831, Portland 7, Oregon • Cables: Tektronix



NEW PRODUCTS

(continued)

quency oscillators as well as a general-purpose laboratory source. The 0.2-watt output, with less than 3-percent distortion, is also adequate for bridge-measurement work and many other fixed-frequency applications. The 1214-A has its own power supply built in. This was done as an economy because the iron-core tuning inductance could have an isolated output coupling coil thus allowing the type 117N7-GT diode-pentode, used as a voltage doubler, to work directly off the a-c line.



Helical Potentiometer

VAN DYKE INSTRUMENTS, INC., 1927 First Ave., South, P.O. Box 355, St. Petersburg 1, Fla., has developed the type H-50 subminiature helical potentiometer. Its resistance element, 12 in. long, is contained within a case $\frac{1}{2}$ in. in diameter. The unit is primarily intended for use in precision bridge-balancing circuits and similar applications where the potentiometer is adjusted by means of an insulated screwdriver or similar adjustment tool. Power rating is 0.5 watt, continuous. Standard resistance values are 250, 500, 1,000, 2,500, 5,000, 10,000 and 25,000 ohms for 10-turn units. Standard tolerance is ± 10 percent overall resistance and ± 0.5 percent linearity.

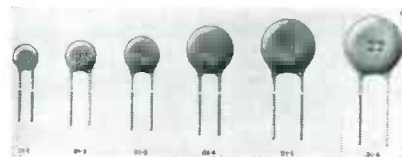

Ceramic Capacitors

ELECTRICAL REACTANCE CORP., P. O. Box 493, Olean, New York, has announced two new lines of Hi-Q ceramic disk capacitors. These



SCARCELY LARGER THAN YOUR DOOR KEY

FOR . . .

Cathode Protection

Gyro Erection

Motor Starting

Integration

Holdovers

Overload Protection

Current Interruptions (Flashers)

Cycling Durations

Emergency Circuit Switchovers

SPECIFICATIONS • MODEL 207

Sealed-in-glass

Arc quenching atmosphere

Precision timing — Final adjustment made after sealing by patented feature

Weight: 1/2 oz. (approx.)

Diameter: 3/4" (approx.)

Height: 2 1/4" maximum (sealed)

Standard Heater Voltages:

115v, 27.5v, 6.3v

Contact Ratings:

2.5 amps @ 125v ac,

1.0 amp @ 125v dc.

Ambient Compensation:

-60 to +85°C

Nominal Heater Input:

2 watts

Mounting: Miniature Button
7-pin

Range of Delay Periods:
5 secs. to 120 secs.

OTHER INSTRUMENT DIVISION PRODUCTS

Sealed Thermostats

Sensitive Relays

Temperature Monitors

Electrical Resistance Bulbs

YOU CAN ALWAYS RELY ON EDISON

Announcing

**. . . a NEW
Miniature by
EDISON**

EDISON announces its new Model 207 Miniature Thermal Relay — designed to meet the need for a space-saving time-delay relay.

Into the design and development of this sealed-in-glass miniature, EDISON has applied the experience of over 20 years in the thermal engineering field and has built into it many of the quality features of the widely-used EDISON Model 501 Thermal Relay. In numerous applications the two relays have similar operating characteristics.

Pilot production started in December 1951. For free bulletin, just clip coupon and mail.



Instrument Division • West Orange, N. J.

To: *Instrument Division*, THOMAS A. EDISON, INC.
63 Lakeside Avenue, West Orange, New Jersey

We may have an application for your Miniature Thermal Relay to _____

Please send E3 bulletin to: _____

Name and title _____

Company _____

Address _____

JOHNSON

INSULATED SHAFT COUPLINGS

NEW PRODUCTS

(continued)

temperature-compensation disk capacitors have a capacitance range of 475 μmf on the D1-6 N1400 material down to 0.3 μmf on the D1-1 size with tolerances of ± 5 percent or greater. Conforming to RTMA, Class I ceramic capacitors they are conservatively rated for working voltage at 500 v d-c and flash tested at 1,500 v d-c. Extended-temperature compensating disk capacitors were developed for applications requiring a very large gradient of capacitance versus temperature. They exhibit relatively higher dielectric constants permitting capacitances in the range intermediate between the high K and linear or normal group of ceramics. The Q (a minimum of 250 at 1 mc) is somewhat lower than the Class I ceramics.

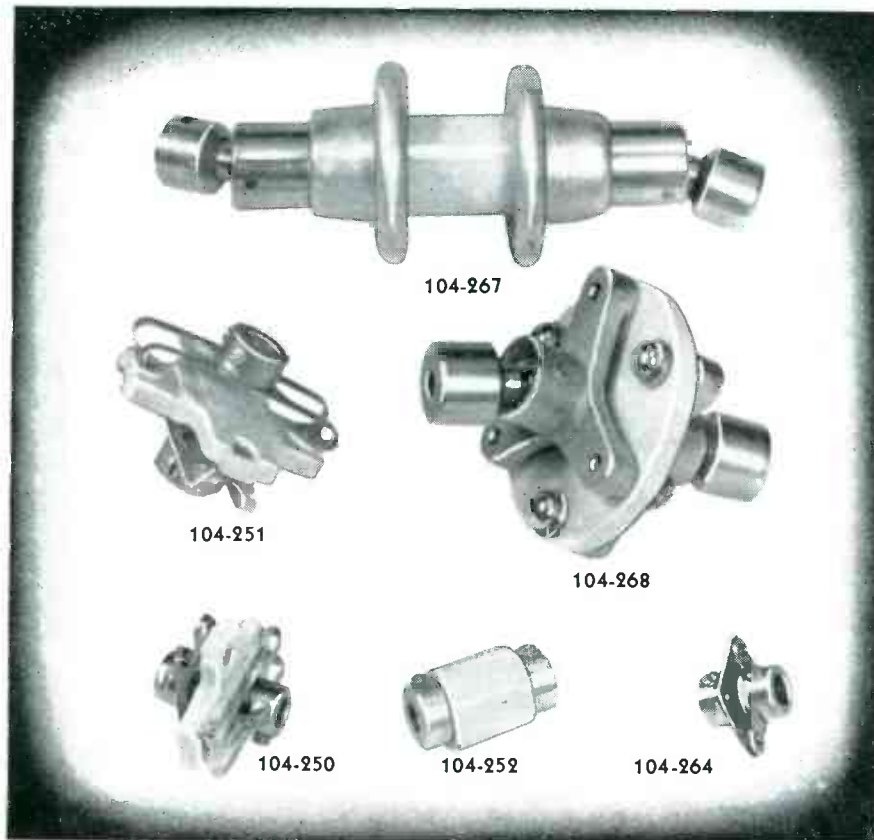

There's a JOHNSON shaft coupling for virtually any electronic application. All are manufactured with high quality, low loss insulation; accurately machined and suitably finished metal parts. Each is capable of many thousands of operating cycles without failure due to fatigue. Voltage ratings are DC "breakdown" degraded in accordance with good engineering practice.

- 104-250 Steatite insulation with hubs mounted on phosphor bronze springs. Coupling may be used to compensate for minor shaft misalignment. Hubs drilled for 1/4" shafts and equipped with two sets of hardened set screws. Ratings: torque 48 inch/ounces with 1° back lash; voltage, 4,000; capacity, 1.4 mmf.
- 104-251 A larger version of 104-250 for 3/8" shafts. Voltage breakdown exceeds 8,000; capacity 1.75 mmf., torque 84 inch/ounces with 1° back lash. Available for 1/4" shafts as 104-251A.
- 104-252 A rigid coupling for 1/4" shafts tested for 128 inch/ounces torque. Glazed Steatite insulation, capacity 1.6 mmf., breakdown voltage 7,000.
- 104-264 Phenolic insulation rated at 750 volts DC. Brass nickel plated hubs drilled for 1/4" shafts and equipped with dual set screws. Torque rating approximately 50 inch/ounces with 1° back lash. Capacity 1.4 mmf.
- 104-267 A coupling for extremely high voltage applications. Equipped with corona shields and Steatite insulation, breakdown voltage exceeds 20,000 volts. Universal joint type hubs drilled for pins and furnished with socket head screws. coupler will compensate for considerable misalignment of shafts. Breaking strength exceeds 5 foot pounds, free play less than 3.0°. Capacity 3.5 mmf.
- 104-268 A true universal joint type coupling capable of smoothly transmitting large torque values thru 1/4" shafts angularly displaced as much as 45°. Breaking strength exceeds 7 foot/pounds with free play less than 3°. Hubs equipped with socket head screws and drilled for pins. Steatite insulated; breakdown voltage 7,500. Capacity 6.0 mmf.

The newest JOHNSON General Products Catalog 972 lists numerous additional shaft couplers. Write for your copy today. If you have problems involving special shaft couplers we will be pleased to quote on production quantities.

Magnetic Tape Recorder

AMPEX ELECTRIC CORP., Redwood City, Calif. Model 307 magnetic tape recorder, especially designed for recording signals telemetered from aircraft and missiles, is the second of a line of special recorders designed for recording original telemetered data. It has a frequency range of from 100 to 100,000 cps, thereby permitting the recording of all f-m/f-m telemetering channels recommended by the Telemetering Panel of Research and Development Board. The recorder is designed for three tape speeds: 60, 30 and 15 inches per second. The extended frequency range of the unit makes it useful for recording many types of data which previously could be recorded only by

 **E.F. JOHNSON CO.**
WASECA, MINNESOTA

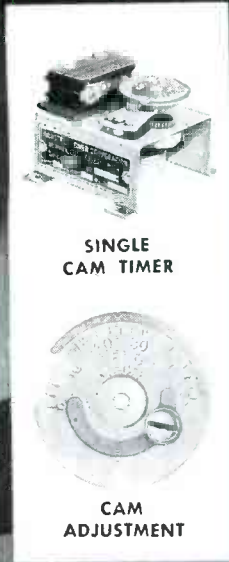

SINGLE CAM TIMER

CAM ADJUSTMENT

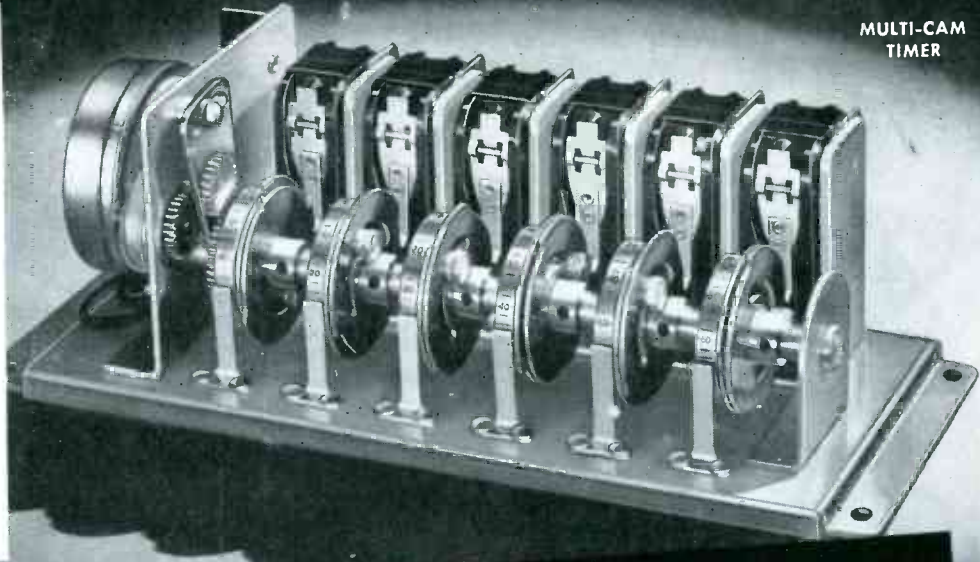

MULTI-CAM TIMER

NEW! Synchronous Motor Driven **SINGLE CAM** and **MULTI-CAM** RECYCLING TIMERS

The new Industrial Cam Recycling Timer continuously repeats a constant cycle consisting of definite ON and OFF periods which can be adjusted from 2% to 98% of the cycle. By means of percentage calibrations on the cam face any desired setting is quickly and accurately obtained. The time cycle itself can also be changed easily by substituting simple gear-rack assemblies. Thus, from one timer, by using different gear racks you can obtain 50 different cycles ranging from the lowest cycle of the timer up to nine times that cycle. The snap action switch operated by the timer is a single pole double throw, totally enclosed 10 ampere type. We can supply 500 different time cycles in this model ranging from one revolution in 15 seconds to one revolution in 72 hours.

The Multi-Cam Recycling Timer is identical to the Single Cam Timer but operates from 2 to 6 circuits and incorporates several additional features. On this timer all cams are mounted on a single driving shaft which assures a common time cycle for all circuits. Each cam, however, is independently adjustable for a specific timing sequence. This is accomplished by actually rotating the cam with finger pressure using the drum calibrations for guidance. Thus a range of timing sequences from 0% to 100% is obtainable on each circuit with ease. The elimination of cam followers and other types of moving parts makes possible this compact unit. 11 models are available with time cycles ranging from one revolution in 1 minute to one revolution in 72 hours.

REMOTE CONTROL FOR SINGLE CYCLE OPERATION AVAILABLE.

Send today for complete details—or, if you would like to send us specifications, we shall be glad to make recommendations based on your particular needs.

Manufacturers of These and Other Timers and Controls for Industry

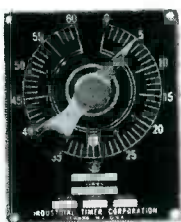

TIME DELAY TIMERS



INSTANTANEOUS RESET TIMERS



MANUAL SET TIMERS

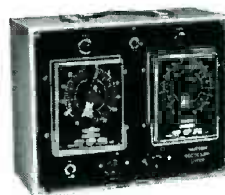

TANDEM AUTOMATIC RECYCLING TIMERS



RUNNING TIME METERS

Timers that Control the Pulse Beat of Industry



INDUSTRIAL TIMER CORPORATION
115 EDISON PLACE, NEWARK 5, N. J.

Check, Grade,
or Sort up to
17 capacitors
per minute



PRICE
\$690⁰⁰
F.O.B. CINCINNATI

with the New *Clippard* PC-4 CAPACITANCE COMPARATOR

Any type of condenser... paper, mica, oil filled, ceramic or electrolytic... can be graded on the PC-4 at rates up to 8000 per day by an unskilled operator. Working to an accuracy of 0.2%, the PC-4 is a companion production instrument to the famous PR-5 Automatic Resistance Comparator. Leading manufacturers have found it an indispensable tool in the fight for higher quality and lower production costs. Easy operation reduces inspection time to an absolute minimum.

Completely self-contained, the PC-4 requires no outside attach-

ments other than the Standard Capacitor against which the unknowns are to be checked. Operates on 110 Volt—60 cycle AC. Range: 10 mmfd to 1000 mfd. Size: 18" x 12" x 12". Weight: approximately 35 lbs. For complete details, write for Catalog Sheet E-2.

Clippard

INSTRUMENT LABORATORY INC.

1125 Bank Street • Cincinnati 14, Ohio

MANUFACTURERS OF R. F. COILS AND ELECTRONIC EQUIPMENT

NEW PRODUCTS

(continued)

means of a cro and moving film camera.



Industrial Gamma Tube

TRACERLAB, INC., 130 High St., Boston 10, Mass., has developed a rugged stainless steel tube especially designed for industrial process control procedures using gamma rays and for cosmic ray counting. Features of the TGC-16 industrial gamma tube include the complete absence of any flanges, bases and base pins making it particularly adaptable for a wide variety of uses, a wall thickness of approximately 400 mg per cm², life greater than 2×10^8 counts, a starting potential of 870-930 volts, and a minimum plateau length of 200 volts with a slope of approximately 1 percent per 100 v. The fill gas used is helium with an organic quench and the tube has a recovery time of approximately 200 μ sec. Overall dimensions of the standard tube are 15 $\frac{1}{4}$ in. x 1 in. o.d.



Super Rhombic Antenna

DAVIS ELECTRONICS, 3047 W. Olympic Blvd., Los Angeles, Calif. The aluminum alloy Super Rhombic antenna is designed to eliminate stacked arrays and overcome the

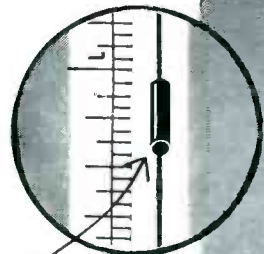

from
MINISEL
 subminiature
 encased
 types
 to
POWERSEL
 high power
 open
 types

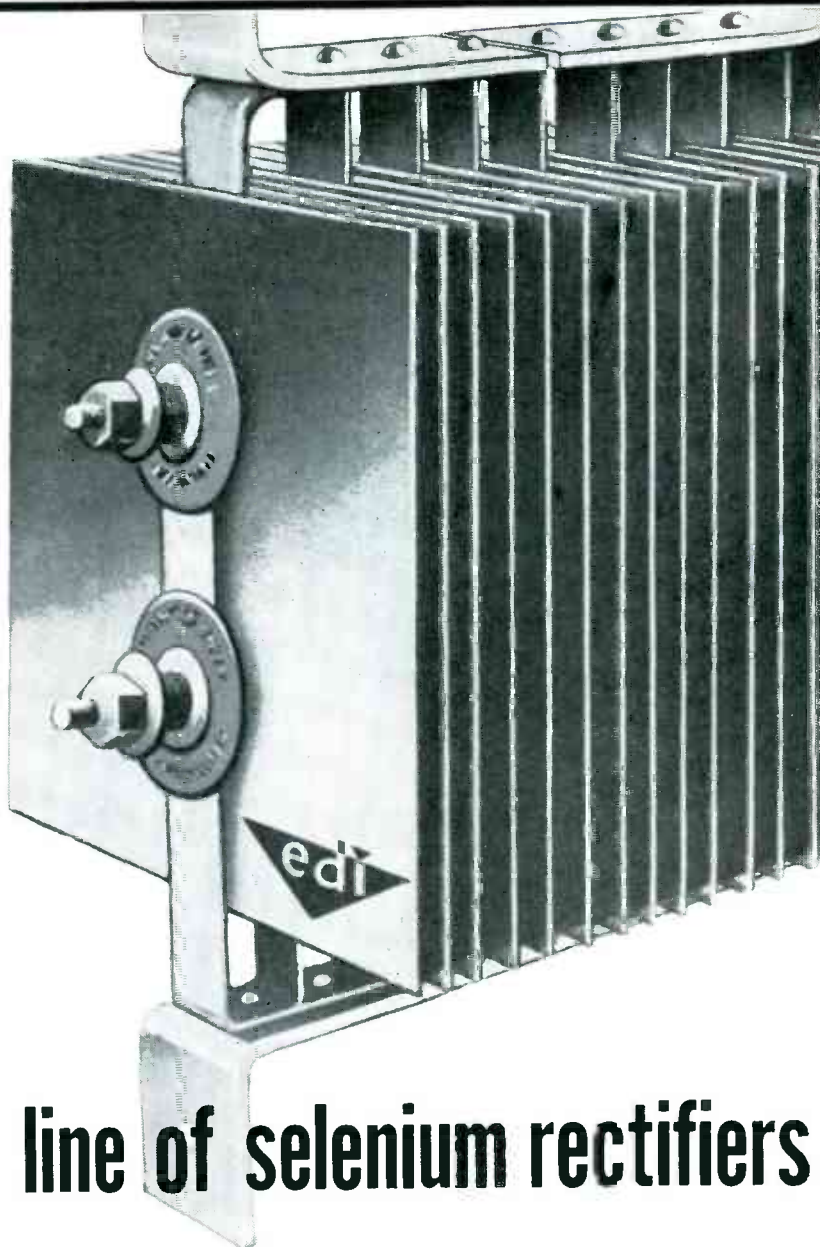

a complete new line of selenium rectifiers

All types and sizes of selenium rectifiers used in military or civilian production. Write or wire for engineering assistance and complete specifications on your individual rectifier problems. No cost or obligation.



MINISEL
 Phenolic
 Cartridge Type



MINISEL
 Sealed-in-Glass
 Fuse Type



MINISEL
 Hermetically Sealed
 Metal Type



PLASTISEL
 Molded-In
 Electronic Type



POWERSEL
 High Power Type
 Rectifier

ELECTRONIC DEVICES, INC.

PRECISION RECTIFIER DIVISION
 429 12th STREET • BROOKLYN 15, NEW YORK

STANDARD

Radio Interference and Field Intensity

MEASURING EQUIPMENT

Complete Frequency Coverage -- 14kc to 1000mc !



NM - 10A VLF

14kc to 250kc
Commercial Equivalent of
AN/URM-6.
Very low frequencies.

HF NM - 20A

150kc to 25mc

Commercial Equivalent of AN/PRM-1.
Self-contained batteries. A.C. supply
optional. Includes standard broadcast
band, radio range, WWV, and commun-
ications frequencies.



NMA - 5A VHF

15mc to 400mc
Commercial Equivalent of
TS-587/U.
Frequency range includes
FM and TV Bands.



UHF NM - 50A

375mc to 1000mc

Commercial Equivalent of
AN/URM-17.
Frequency range includes Citizens
Band and UHF color TV Band.



These instruments comply with test equipment requirements of
such radio interference specifications as JAN-I-225a, ASA C63.2,
16E4(SHIPS), AN-I-24a, AN-I-42, AN-I-27a MIL-I-6722 and others.

STODDART AIRCRAFT RADIO CO.

6644 SANTA MONICA BLVD., HOLLYWOOD 38, CALIFORNIA

Hillside 9294

NEW PRODUCTS

(continued)

problems of fringe and ghost area reception. The antenna gives all-channel coverage with a gain of over 12 db. It has a tilt of 15 degrees, directivity of 12 degrees. Construction permits use of common lead-ins without a matching transformer. Shipped pre-assembled, the light-weight antenna may be installed in a matter of minutes.



Base Loading Coils

MALLARD MFG. Co., 6025 N. Keystone Ave., Chicago 30, Ill., has introduced loading coils for mobile antennas available in two models, for 20 and 75-meter operation, and designed to fit all standard mounts and whips. With the adaptor supplied they can be used with non-standard types. The Hi-Q 20 loading coil is wound with heavy plated 1/4-in. diameter solid copper wire. The Hi-Q 75 features two pie-wound coils of heavy insulated wire adjustable for maximum efficiency over a powdered iron core slug. Coils are treated with Insulex to resist moisture and fungus growth and to maintain high Q.



Tape Transport Mechanism & Preamp

TAPE MASTER, INC., 13 W. Hubbard St., Chicago 10, Ill., has announced model TH21 tape transport mech-

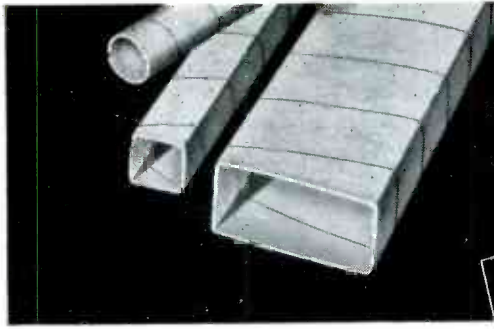

Tubes made by Accurate Paper Tube Company using Quinterra Type 3.

HERE'S PROOF THAT YOU CAN MAKE INDUCTION EQUIPMENT

*Safer...
Smaller...
at Lower
Cost...*

PROOF

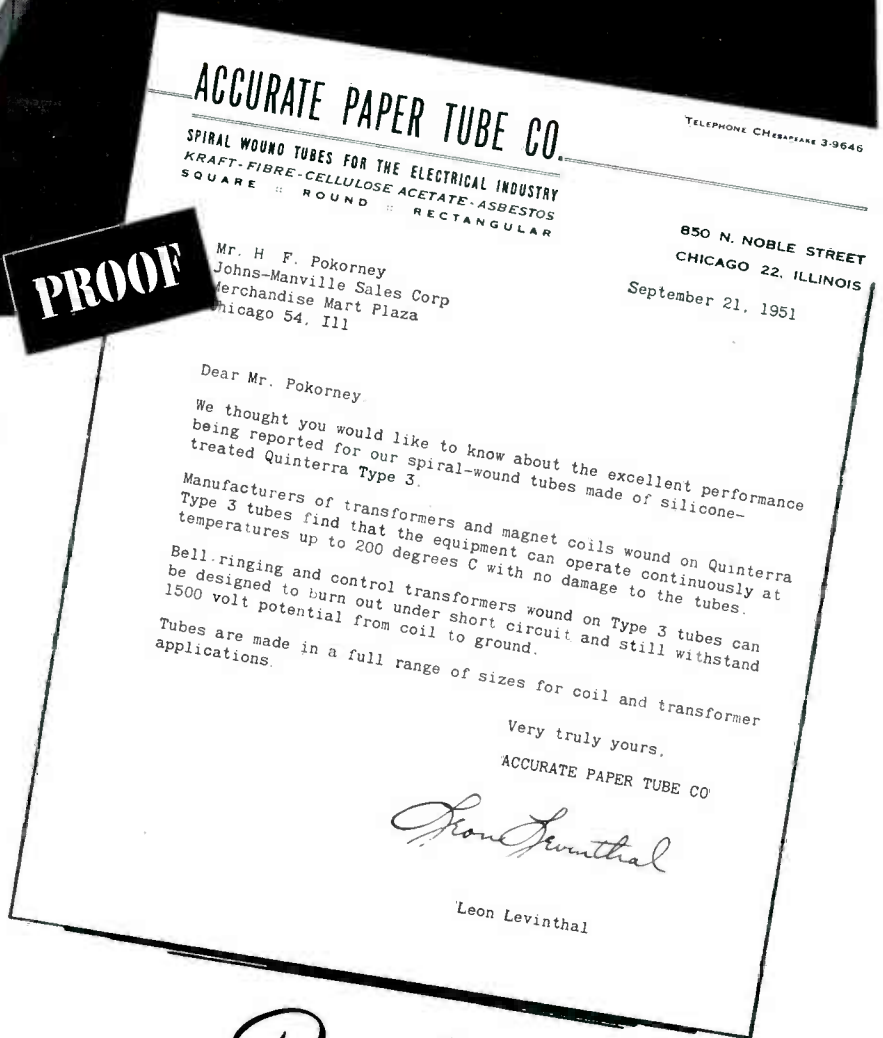

with silicone-treated *Quinterra TYPE 3**
(A purified Asbestos Class H sheet insulation)



TRANSFORMER WITH CONVENTIONAL INSULATION TRANSFORMER WITH SILICONE-TREATED QUINTERRA TYPE 3 INSULATION

Photograph above shows two signal corps transformers having same rated output—illustrating savings in space and materials made possible by use of silicone-treated Quinterra.

As the above letter from the Accurate Paper Tube Company testifies, users of this newest Johns-Manville electrical insulation find that it raises overload limits and assures greater safety.

And as you can see from the photograph at left, Quinterra Type 3 also permits important savings in both space and materials... a fact substantiated by leading manufacturers of quality transformers.

You can not only improve your induction devices with Quinterra Type 3... but you can also reduce the total cost of production because rejections will be minimized.

Silicone-treated Quinterra Type 3 is a high grade Class H dielectric... ideal for both interlayer and wire-wrapping insulation as well as the formation of tubes. It has outstanding moisture resistance, high tem-

perature stability, and electrical characteristics—plus flexibility and adequate physical strength for many applications.

Quinterra Type 3, like all treated Quinterras, is made from a completely inorganic base sheet of purified asbestos that has a hole-free closed structure. This sheet has an inherent dielectric strength of at least 200 VPM which is retained even under temperature of 400 C. The silicone-treated sheet maintains a dielectric strength of at least 225 VPM under continuous exposure to temperatures in excess of the Class H maximum, 180 C.

If you have a problem that Quinterra Type 3 may solve, why not consult our sales engineers—without obligation? For samples and additional information, write Johns-Manville, Box 290, N.Y. 16, N.Y.

*Photo — Courtesy Chicago Transformer Division, Essex Wire Corporation.

*Quinterra is the registered trade mark of Johns-Manville's purified asbestos electrical insulation.



Johns-Manville ELECTRICAL INSULATIONS

HERE'S THE BASIS FOR A MICROWAVE TEST SETUP

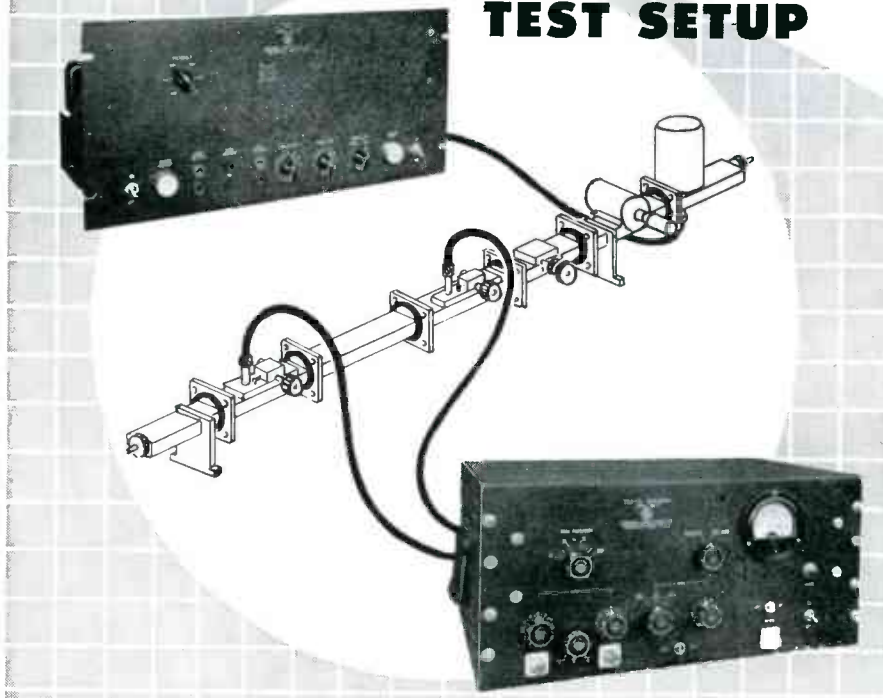

A VERSATILE, dependable laboratory set-up for microwave testing can easily be built around these two Browning instruments.

The basis of a signal generator in the super-high-frequency range is provided in the Model TVN-7 square-wave modulator and power supply. This unit is used as a square-wave modulator at 600 to 2500 cycles for low-power velocity-modulated tubes, such as the 417A, 2K28, and 2K25. Provision is also made for external modulations: for grid pulse modulation at amplitudes up to 60 volts, and for reflector pulse modulation at up to 100 volts maximum. The power supply delivers regulated cathode voltage continuously variable from 280 to 480 volts, with provision for a 180-300 volt range.

Measurement of standing-wave ratios, with slotted lines, is easily accomplished with the Model TAA-16A amplifier — a high-gain a-c voltmeter, covering 500 to 5000 cycles per second. Front-panel controls can be set for broad-band or selective operation; sensitivities are: $15\mu\text{v}$ in broad-band and $10\mu\text{v}$ in selective position. The 4 inch output meter with illuminated scales is graduated in standing-wave voltage ratio and with a 0-10 linear scale. A panel switch is provided for convenience in applying bolometer voltage. The master gain control switch provides attenuation factors of 1, 10, and 100. Unit and regulated power supply are contained in black wrinkle steel cabinet 9 x 20 x 12 inches.

Both of these instruments are designed for 115-volt 50/60 cycle operation.

Write today for data sheets giving detailed specifications of the TVN-7 and TAA-16A equipments.



ENGINEERED
FOR
ENGINEERS

BROWNING
Laboratories, Inc.
Winchester, Mass.

anism and a matching preamp-bias erase oscillator. The mechanism illustrated operates at a tape speed of $7\frac{1}{2}$ in. per sec and incorporates both fast forward and fast rewind, single switch control, an oversized motor and practically vibrationless operation. The model PA-1 preamp unit is fully wired and incorporates a push-pull bias-erase oscillator, full monitoring, inputs for both radio-phono and microphone, outlets for amplifier and headphones, complete master switching and neon recording level indicator. Combination of both units with any high grade audio amplifier makes a complete high-fidelity tape recording and playback system. Net price for both is \$81.50.



Resin Core Solder

KESTER SOLDER Co., 4201 Wrightwood Ave., Chicago 39, Ill., has announced a new and highly active resin flux known as "44" resin. The solder melts, wets the metal and flows or spreads all in one instantaneous action with such speed that it is impossible to distinguish the separate actions. The solder is non-corrosive and electrically nonconductive. It conforms with Army-Navy-Air Force specifications MIL-S-6872 (AN-S-62) and the extremely rigid USAF specification No. 41065-B Method 31, also Federal specification QQ-S-571b. For complete information write for bulletin 444.

Extra-Thin High-Heat Insulation

IRVINGTON VARNISH & INSULATOR Co., 6 Argyle Terrace, Irvington 11,

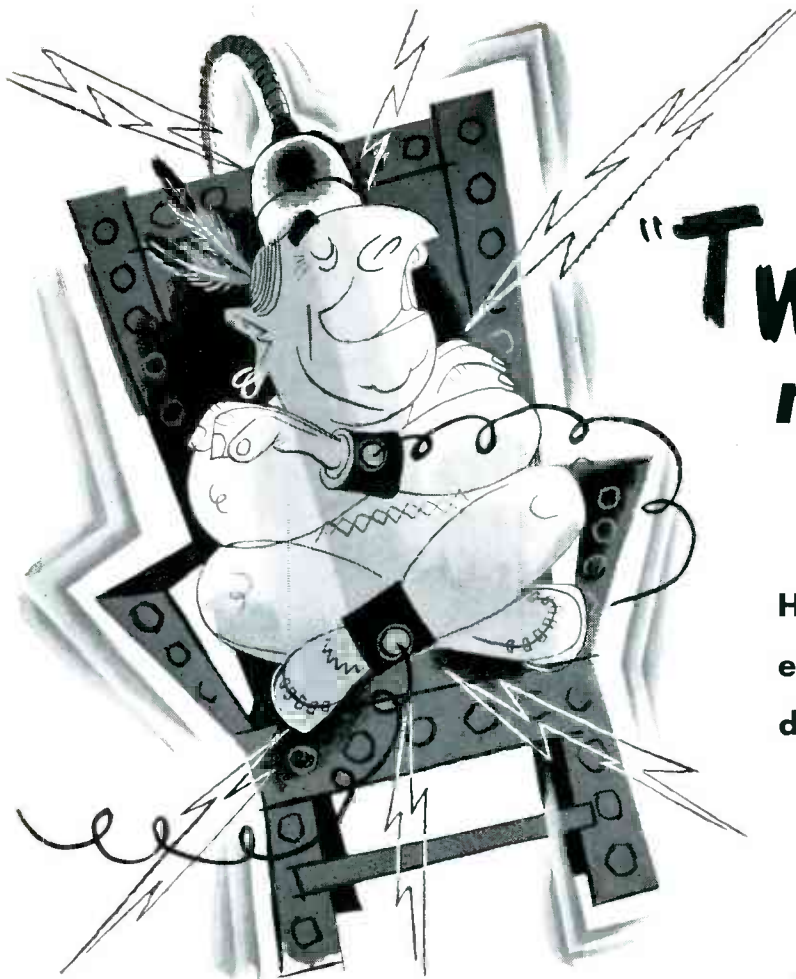

Sangamo "Twist-Tabs" never flinch in a hot seat!

High surge voltages and
extreme ripple currents
don't faze them...



*Type PL Electrolytic Capacitors

Sangamo "Twist-Tab" (Type PL) Electrolytic Capacitors are designed particularly for all television and electronic applications that demand long life and dependable performance at 85° C under conditions involving extreme ripple currents and high surge voltages.

These quality components are sealed in round aluminum cans and have twist prong tabs for washer or direct chassis

mounting. All connections from the capacitor are securely fastened to the terminal lugs, providing permanent low resistance connections. The aluminum cans are negative, and the mounting ring provides the negative connection.

Sangamo "Twist-Tabs" offer a selection from the largest listing of capacities and voltages available from any single source. Write for full information.

Your Assurance of Dependable Performance

SANGAMO ELECTRIC COMPANY

MARION, ILLINOIS

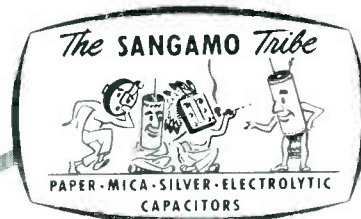

IN CANADA: SANGAMO COMPANY LIMITED, LEASIDE, ONTARIO

SC52-1

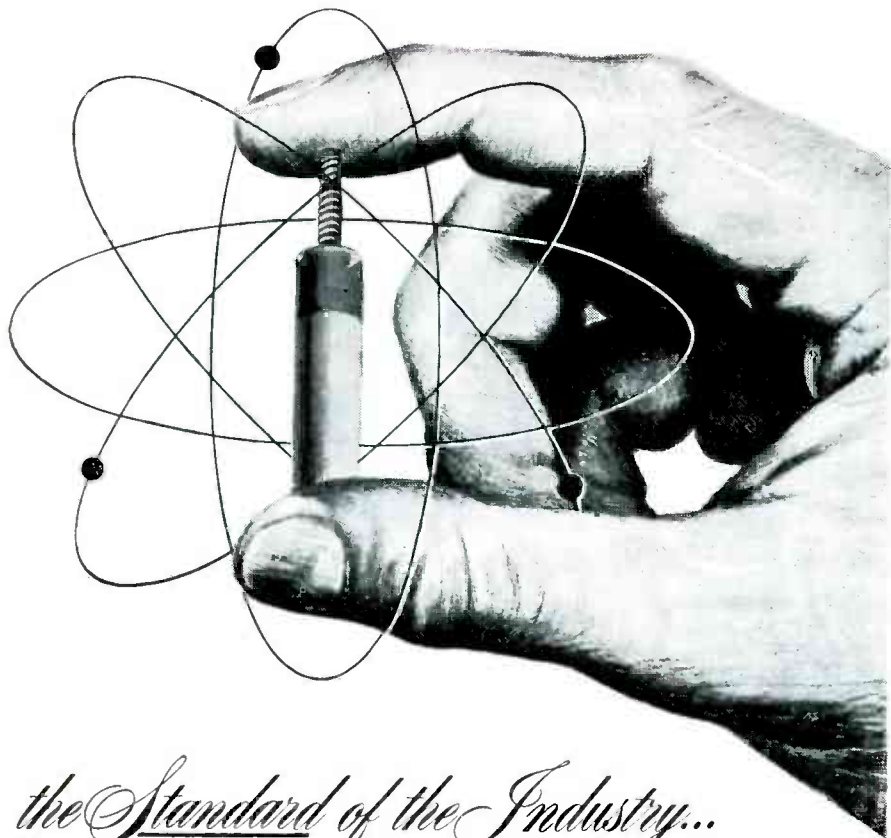

the Standard of the Industry...

MOLDITE IRON CORES

Moldite offers the advantages of volume production combined with absolute precision . . . the sure results of its special formulas and advanced production techniques . . . engineering cooperation on every iron core application. Moldite Iron Cores meet every requirement for dependability. They are the standard wherever the finest in electronic equipment is made.

**MAGNETIC IRON CORES • FILTER CORES • MOLDED COIL FORMS
THREADED CORES • SLEEVE CORES • CUP CORES**

NATIONAL



COMPANY

1410 Chestnut Ave., Hillside 5, N. J.

Samples promptly
submitted upon request
for design, pre-production,
and test purposes

SEND FOR CATALOG 110

Robert T. Murray
614 Central Ave.
East Orange, N. J.

Jerry Golten Co.
2750 W. North Ave.
Chicago 22, Ill.

Martin P. Andrews
Mott Road
Fayetteville, N. Y.

Perlmuth-Colman & Assoc.
1335 South Flower
Los Angeles, Cal.

Jose Luis Pontet
Cardoba 1472
Buenos Aires

N. J., has available a new insulation known as Silicone-resin-coated Novabestos. Although but 0.003 in. thick, it can be used at operating temperatures of 180 C. It is composed of 97-percent-pure asbestos and 3 percent organic material. The long fiber construction of this base asbestos sheet also gives it unusual physical properties for such a thin material.



High-Voltage Probe

PRECISE DEVELOPMENT CORP., Oceanside, L. I., N. Y. Model 999 high-voltage probe has multiple insulation: two areas of air insulation, plastic inside insulation and an outside plastic insulation which protects against voltage breakdown. Tips are interchangeable and include an alligator clip plus the conventional probing type. The probe also has interchangeable resistors for use with any vtvm or 20,000 ohms-per-volt meter. Price is \$6.98.



TV Receiver Tube

GENERAL ELECTRIC Co., Schenectady 5, N. Y., has developed type 6BK7 low-cost miniature tv receiver tube designed to reduce snow in fringe

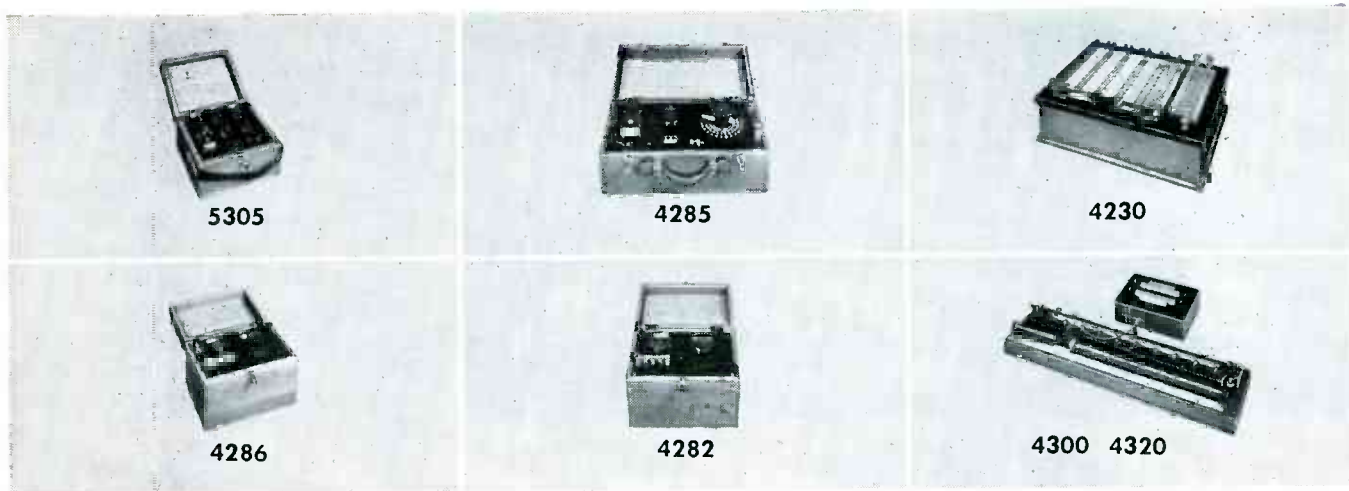

For D-C Resistance Measurements...

check this complete L&N line

Wheatstone Bridges

Model	List No.	Limits of error	Ratio Arms	Comparison Standard
Anthony Pattern for laboratory standard	DM-4230	$\pm 0.03\%$	Two sets of 1, 10, 100, 1000, 10,000 Ω †	0 to 11,111 Ω †
Open Dial Switch for high precision	DM-4725	$\pm 0.06\%$	Two sets of 1, 10, 100, 1000, 10,000 Ω †	0 to 10,000 Ω ‡
Enclosed Switch for moderate precision	DM-4760	$\pm 0.15\%$	Seven settings, 0.001, 0.01, 0.1, 1, 10, 100, 1000	0 to 9,999 Ω
Post Office Pattern for student instruction	DM-4250	$\pm 0.15\%$	Each have four resistors, 1, 10, 100, 1000 Ω †	0 to 11,110 Ω †
Type S-1 Test Set for resistance measurement and fault location	DM-5300*	$\pm 0.15\%$	Seven settings, 0.001, 0.01, 0.1, 1, 10, 100, 1000 Has provision for Murry and Varley Loop Tests‡	9(1+10+100+1000) Ω ‡
Type S-2 Test Set for resistance measurement	DM-5305*	$\pm 0.15\%$	Seven settings, 0.001, 0.01, 0.1, 1, 10, 100, 1000	9(1+10+100+1000) Ω ‡
Ohmmeter for rapid routine testing	DM-4282*	$\pm 1\%$	Slidewire approximately 12" long, calibrated 0 to infinity. Continuously adjustable	1, 10, 100, 1000, 10,000 Ω †
Per Cent Limit for fast resistor inspection	DM-4270	$\pm 0.5\%$	0 to $\pm 15\%$	Uses external standard resistor
Type U Test Set for locating cable faults	DM-5430A*	$\pm 0.15\%$	Eight settings, 1/1000, 1/100, 1/10, 1/9, 1/4, 1/1, 10/1, 100/1. Has provision for Murry and Varley Loop Tests‡	Four decades 10(1+10+100)+9 x 1000 Ω † infinity

* Portable self-contained unit, includes battery and galvanometers. † Plug and block connectors. ‡ Rotary switches.

Kelvin Bridges

Model	List No.	Limits of error	Ratio Arms	Comparison Standard	Range
Precision for precise measurement	DM-4320 DM-4300	$\pm 0.05\%$	Two sets of 100, 300, 400, 1000 and 10,000 Ω .	Nine fixed resistors, each 0.001 Ω and 0.001 Ω graduated bar having 110 div.	0.01 $\mu\Omega$ to 1 Ω
General Purpose for moderate precision	DM-4306	$\pm 0.1\%$	Seven settings: 0.1, 0.2, 0.5, 1, 2, 5, 10.	Nine fixed sections and a divided bar, each 0.01 Ω . Scale has 100 div.	0.00001 Ω to 1 Ω
Student's for teaching	DM-4340	$\pm 0.7\%$	Three Settings: 0.1, 1, 10.	Bar, total resistance 0.01 Ω . Scale has 100 divisions.	0.00001 Ω to 0.1 Ω
Portable for moderate precision	DM-4285*	$\pm 0.25\%$	Adjustable slidewires, 1.5 to 2.66 and 1 to 1.6	Dial switch, 0.0001, 0.0002, 0.0005 etc. up to 10 Ω .	0.0001 Ω to 26.6 Ω
Ohmmeter for routine testing	DM-4286*	$\pm 2\%$	Adjustable slidewires; 0.01 to 0.11	Plug switch 0.01, 0.1, 1, 10, 100	0.0001 to 11 Ω
Hoopes Conductivity for production testing conductor wire	DM-4870	$\pm 0.2\%$	Adjustable slidewires to compensate for sample weight.	4872 Copper Std. calibrated to International Annealed Copper Std. Gauge nos. 21, 18, 15, 12, 9, 6, 3, or 0 as specified.	0 to 105% conductivity

*Self contained

For more information, send for Catalog E-33, D-C Resistance Measurements.

LEEDS & NORTHRUP COMPANY
4979 STENTON AVENUE, PHILADELPHIA 44, PA.

RECTIFIER TUBES

RUGGEDIZED BY
ECLIPSE-PIONEER
FOR ADDED RELIABILITY

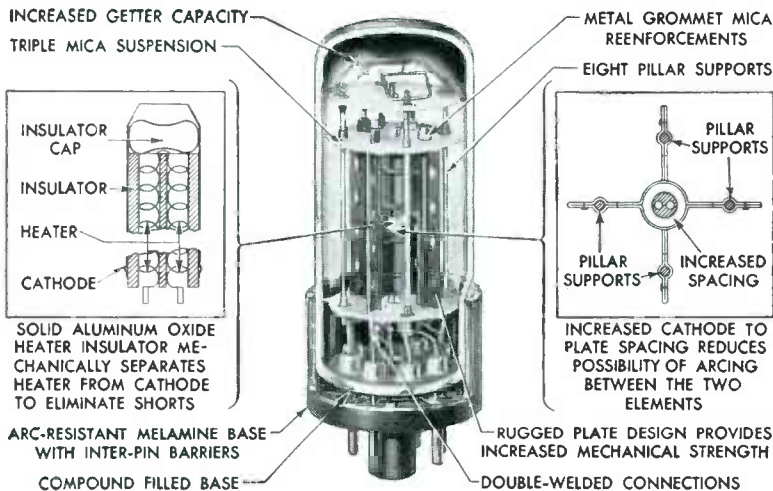

We are not in the standard vacuum tube business, but we are in the business of developing and manufacturing a reliable line of special purpose electron tubes—tubes that will serve and meet the stiff and varied operational requirements of aviation, ordnance, marine and other fields of modern industry. Typical of these are receiving type tubes such as Beam-Power Amplifiers, R-F Pentodes, Twin Triodes, and the Full-Wave Rectifiers illustrated above and described

below. All of these tubes are exhausted on a special automatic exhausting machine capable of extra high evacuation, and are aged under full operating and vibration conditions for a period of 50 hours. In addition to the tubes described above, Eclipse-Pioneer also manufactures special purpose tubes in the following categories: gas-filled control tubes, Klystron tubes, spark gaps, temperature tubes and voltage regulator tubes.

LOOK FOR THE PIONEER MARK OF QUALITY
REG. U. S. PAT. OFF.

Electrical Characteristics of E-P Full-Wave Rectifier Tubes

TUBE TYPE	R.M.A. 5838	R.M.A. 5839	R.M.A. 5852	R.M.A. 5993
Heater Voltage	12 volts	26.5 volts	6.3 volts	6.3 volts
Heater Current	0.6 amps.	0.285 amps.	1.2 amps.	0.80 amps.
Peak Inverse Voltage	1375 v. (max.)	1375 v. (max.)	1375 v. (max.)	1250 v. (max.)
Peak Plate Current (per plate)	270 ma. (max.)	270 ma. (max.)	270 ma. (max.)	230 ma. (max.)
D-C Heater-Cathode Potential	450 v. (max.)	450 v. (max.)	450 v. (max.)	400 v. (max.)
Cathode Heating Time	1 min.	1 min.	1 min.	45 sec.
Total Effective Plate Supply Impedance	150 ohms (min.)	150 ohms (min.)	150 ohms (min.)	150 ohms (min.)

Other E-P precision components for servo mechanism and computing equipment:

Synchros • Servo motors and systems • rate generators • gyros • stabilization equipment • turbine power supplies and remote indicating-transmitting systems.

For detailed information, write to Dept. C

ECLIPSE-PIONEER DIVISION of

TETERBORO, NEW JERSEY

Export Sales: Bendix International Division, 72 Fifth Avenue, New York 11, N. Y.



area reception. Noise factor is 7 db as a cascode amplifier at 216 mc. Intended primarily for cascode service in vhf reception, it may also be used as a low-noise first-intermediate-frequency amplifier in uhf. Typical operating conditions include: plate supply voltage, 150 v; cathode bias resistor, 56 ohms; amplification factor, 40; plate resistance, 4,700 ohms; transconductance, 8,500 μ mhos; plate current, 18 ma.



Toroidal Cores

LENKURT ELECTRIC Co., 1113 County Road, San Carlos, Calif., is now producing moulded powdered-iron toroids in a size range extending from 0.800 to 3.375 in. outside diameters. Included is the wedding-ring type, the smaller size illustrated. These are available in magnetic materials which can be chosen to accentuate high-Q, high inductance, low generation of harmonic distortion products, high magnetic and temperature stability, or small size and low cost. The same cores are also supplied wound to individual specifications, cased, uncased, or hermetically sealed.



Regulated Power Supply

KEPCO LABORATORIES, INC., 149-14 41st Ave., Flushing, N. Y. Model 1020 high-voltage-regulated power

Help to Engineers



who are concerned with the future of their careers

ARE YOU IN A "DEAD END" JOB with no chance to move forward?

Would you like work that challenges your creative thinking and skills?

Is your present position limiting your opportunity for the complete expression of your talents in electronics?

Do you and your family worry about your career, or where you live now, or about security and your future?

If the answer is "yes" to one or more of these questions—then you should send for a free copy of RCA's new booklet **CHALLENGE AND OPPORTUNITY, The Role of the Engineer in RCA.**

This 36-page, illustrated booklet, just off the press, will show you the splendid opportunities offered by RCA to put your career on the upswing. See how, as part of the RCA team, daily contact with the

best minds in various fields of electronics, and with world-renowned specialists will stimulate your creative thinking.

For graduate engineers who can see the challenge of the future, RCA offers opportunities for achievement and advancement that are legion. Send for a copy of **CHALLENGE AND OPPORTUNITY, The Role of the Engineer in RCA.** It is yours free for the asking.

**Awards . . . Special Recognition
Retirement Plan . . . Insurance
Protection Program**

**RCA Engineering Activities
and Policies**

**Pleasant Communities in
Which to Live and Work**

**Facilities to Support Fully
Every Requirement**

**How RCA Serves the Government,
Science and Industry**

**Opportunities for Progressive
Growth and Advancement**

**RCA Tubes . . . Pace Setters for
Our Electronized Civilization**

To Qualified Engineers:
If you qualify for any of the positions listed below, write us for a personal interview—include a complete résumé of your education and experience. Write to address in coupon.



RADIO CORPORATION of AMERICA

MAIL COUPON NOW!

POSITIONS OPEN IN THE FOLLOWING FIELDS:

- **Television Development**
- **Electron Tube Development**
- **Transformer and Coil Design**
- **Communications**
- **Radar—Missile Guidance**
- **Computer Development and Design**
- **Navigational Aids**
- **Technical Sales**
- **Electronic Equipment Field Service**

MR. ROBERT E. McQUISTON, Manager
Specialized Employment Division, Dept. 46B.
Radio Corporation of America
30 Rockefeller Plaza, New York 20, N. Y.

Without obligation on my part, please send me
a free copy of **CHALLENGE AND OPPORTUNITY**

Name _____

Address _____

City _____ State _____

List degree or degrees _____

DO YOU MAKE FERRITES?

If so, you'll be well repaid by getting the facts on a special group of Pure Ferric Oxides, developed by Williams and manufactured especially for this purpose.

Williams Ferric Oxides analyze better than 99% Fe_2O_3 . They contain a minimum of impurities. They are available in a broad range of particle sizes and shapes. Among them, we're certain you'll find one that's "just right" for your requirements. The proper application of Ferric Oxides to the manufacture of Ferrites is our specialty. So write today, stating your requirements. We'll gladly send samples for test. Chances are good that our Ferric Oxide "Know How" can save you considerable time and money. Address Department 25, C. K. Williams & Co., Easton, Pennsylvania.

WILLIAMS
COLORS & PIGMENTS

C. K. WILLIAMS & CO.

Easton, Pa. • East St. Louis, Ill. • Emeryville, Cal.

NEW PRODUCTS

(continued)

supply is continuously variable from 0 to 1,000 v and delivers from 0 to 50 ma. In the 100 to 1,000-volt range the output voltage variation is less than 0.1 percent both for line fluctuations from 105 to 125 v and load variation from minimum to maximum current. In the 30 to 100-v range output voltage variation is less than 0.5 percent for both. Ripple is less than 10 mv. There is included a 6.3-volt, 10-ampere a-c output. The unit measures $10\frac{1}{2}$ in. high \times 19 in. wide \times 13 in. deep and weighs 66 lb.

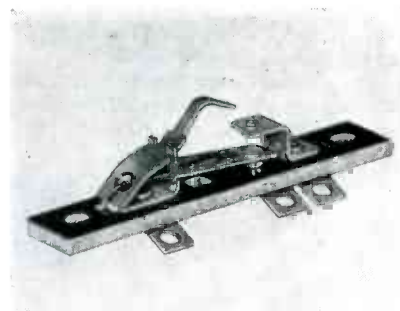

Snap-Action Switches

CHERRY-CHANNER CORP., 1488 Skokie Blvd., Highland Park, Ill., has developed two new standard model snap-action switches. The switches are mounted on Bakelite panels; bracket and actuator materials are brass; blades are phosphor bronze and contacts are of fine silver. Type 2000 has a release force of 5.5 oz and requires an operating force of 7.5 oz. Type 2001 has a release force of 2.7 oz and requires an operating force of 4 oz. Both are Underwriters' Laboratories inspected and have ratings of 6 amperes, 125 volts a-c and 3 amperes, 250 volts a-c.

Power Supply

WESTINGHOUSE ELECTRIC CORP., 306 Fourth Ave., Pittsburgh 30, Pa. Need for an adjustable source of power up to 5 kw and at any frequency up to about 10,000 cycles can now be satisfied electronically. A new power amplifier for any of the audio frequencies below 1,000 cycles takes a signal of about 0.01 watt from any conventional source and builds it up to 5 kw. The power supply uses aircooled apparatus (a WL 5736 power tube) and a Rectox

R.F. INTERFERENCE FILTERS

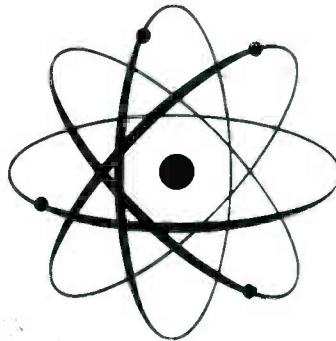

• **Facilities Available Immediately**

- R.F. Ranges to 1000 megacycles
- Manufactured to **SPECIFIC** Requirements
- Conformity to **Military Specifications**
- Experienced **Electronic Engineers**
- Completely Equipped **Laboratories**

Send your blueprints or engineering specifications today for immediate action:

Air Associates

INCORPORATED
TETERBORO, NEW JERSEY



ELECTRONIC PRODUCTS DIVISION

513 JOYCE STREET

ORANGE, N. J.

IMMEDIATE DELIVERY from RADIO SHACK

EICO INDUSTRIAL TEST EQUIPMENT IN WIRED AND KIT FORM, AT ASTONISHINGLY LOW PRICES!

1. Laboratory Precision
2. Lowest Cost
3. Lifetime Dependability
4. Speedy Operation



15-RANGE V.T.V.M.

Model 221 — AC/DC volts: 0-5-10-100-500-1000, extended with probes. 0-1000 ohms, 0-1-10-100-1000 meg; db —20 to plus 16. Dual triode balanced bridge; 1% multiplier resistors; 4½" meter. DC input resist. 26 meg.
EICO 221-K Kit \$25.95
EICO 221 Wired 49.95



BATT. ELIM/CHARGER

Gives 10A DC @ 5-8V cont., 20A int. For 110-120V AC.
EICO 1040-K Kit \$25.95
EICO 1040 Wired 34.95



20K OHMS PER VOLT MULTIMETER

Model 555 — 31 ranges: DC/AC output: 0-2.5-10-50-250-1000-5000V (DC @ 20K ohms/volt, AC @ 1000). 0-2000-200K ohms, 0-20 meg. 5 db ranges, —12 to plus 55. DC current 0-100 ua, 0-10-100-500 ma, 0-10A.
EICO 555-K Kit \$29.95
EICO 555 Wired 34.95



RF SIG. GENERATORS

Stable Hartley osc., 7 bands. 150 kc to 34 mc on fund., harmon. to 102 mc.
EICO 320-K \$19.95
EICO 320 Wired 29.95
New! Sig-Gen with ind. cal. bands. EICO 322-K \$23.95 kit; EICO 322 wired \$34.95.

1000 OHMS PER VOLT MULTIMETER

31 ranges, 3½" meter. AC/DC volts: 0-1-5-10-50-100-500-5000. 0-700, 0-100K ohms, 0-1 meg. AC/DC current 0-1-10 ma, 0-0.1-1A. Six db ranges, —20 to plus 69.
EICO 526-K Kit \$13.90
EICO 526 Wired 16.90



YOUR ENGINEERING AND PURCHASING MEN NEED THE RADIO SHACK CATALOG!

Radio Shack's 192-page 1952 catalog will be sent FREE on request — tell us how many your company needs. Full details, illustrations, net prices on 15,000 components, including the complete EICO instrument line of 15 kits and 17 wired



5" OSCILLOSCOPE, CHOICE OF LABS AND SCHOOLS!

Model 425 — available in complete kit or factory wired form. Push-pull deflection; sensitivity .05 to .1 rms volt/inch. Range 5 cps to 500 kc.; wide-range multi-vibrator sweep circuit 15-75,000 cps. Provision for external sync. Z-mod. and direct input to CR tube plates. Calibr. voltage terminal on panel. Graph screen. Complete, with 58P1 and all tubes! For 110-120V 60 cy AC. Complete instructions for building and operating. The lowest-price quality scope in America. Fully guaranteed.
EICO 425-K Scope Kit \$44.95
EICO 425 Wired Scope 79.95

MAIL ORDER CHECK LIST

Please send me the following items:

NAME _____	EICO 425-K	<input type="checkbox"/>
	EICO 425	<input type="checkbox"/>
COMPANY _____	EICO 221-K	<input type="checkbox"/>
	EICO 221	<input type="checkbox"/>
STREET _____	EICO 1040-K	<input type="checkbox"/>
	EICO 1040	<input type="checkbox"/>
CITY _____	EICO 555-K	<input type="checkbox"/>
	EICO 555	<input type="checkbox"/>
STATE _____	EICO 320-K	<input type="checkbox"/>
	EICO 320	<input type="checkbox"/>
EICO CATALOGS <input type="checkbox"/>	EICO 526-K	<input type="checkbox"/>
RADIO SHACK CATALOGS <input type="checkbox"/>	EICO 526	<input type="checkbox"/>

RADIO SHACK CORPORATION

167 Washington St., Boston 8, Mass.

NEW PRODUCTS

(continued)

rectifier for the high-voltage element. Such power supplies are useful in laboratories, in connection with vibration studies, and in many industrial processes.



Distribution Amplifier

BLONDER-TONGUE LABORATORIES, 38 North 2nd Ave., Mount Vernon, N. Y. The DA8-1-M 8-outlet all-channel distribution amplifier for master antenna systems has 4 tv set outlets on the front, and 4 on the rear of the unit. The simple screw-type terminals will handle both 75 and 300-ohm line. Matching transformers are built in. Need for special connectors, individual channel equipment and engineering services has been eliminated. Any required number of DA8-1-M units can be connected together to form a system to supply up to 2,000 tv sets. List price is \$87.50.



Timing Motor

HAYDEN MFG. CO., INC., 2433 Elm St., Torrington, Conn., has developed a new 400-cycle timing motor for use as time standard in applications involving relatively light loads. This hysteresis-type syn-

chronous timing motor is designed for use either as a separate component or in a variety of types of standard timers. At any given frequency control it is better than with comparable d-c motors because variations in temperature, supply voltage and load, within the operational limits of the motor, do not affect timing. Full technical data may be found in Engineering Bulletin No. 2.



Deflection Yokes

STANDARD TRANSFORMER CORP., 3580 Elston Ave., Chicago, Ill. Two new deflection yokes with cosine distributed windings designed to provide antiastigmatic focusing over the entire tv tube picture area have been announced. The DY-8 and DY-9, latest components in the company's tv replacement line, are both 70 deg, ferrite core deflection yokes with coils wound on nylon bobbins. Type DY-8 has a horizontal inductance of 8.5 mh and DY-9 has a horizontal inductance of 13.5 mh. Each is priced at \$10.75. Bulletin 387 describes both in detail.



Test Leads

INSULINE CORP. OF AMERICA, 3602-35th Ave., Long Island City 1, N. Y., has brought out a pair of extra-long-handled test leads designed

IN STOCK

CHICAGO

MIL-T-27

TRANSFORMERS

**POWER ★ BIAS
FILAMENT
FILTER ★ AUDIO**

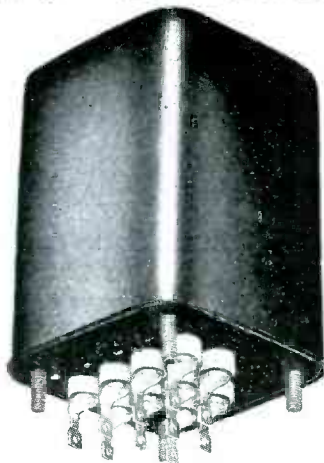

CHICAGO MIL-T-27 TRANSFORMERS are the world's toughest . . . America's finest complete line that meets military specifications. An exclusive process of

bonding steel base covers in seamless drawn-steel cases by deep-seal soldering insures continuous service under the most adverse conditions.

**YOUR ORDERS FILLED NOW ON
CHICAGO REPLACEMENT, PULSE,
TELEVISION, NEW EQUIPMENT
TRANSFORMERS - FROM STOCK!**

**RADIO SHACK'S PERPETUAL INVENTORY OF CHICAGO TRANSFORMERS,
FILTER REACTORS AND CHOKES IS ONE OF AMERICA'S LARGEST!**

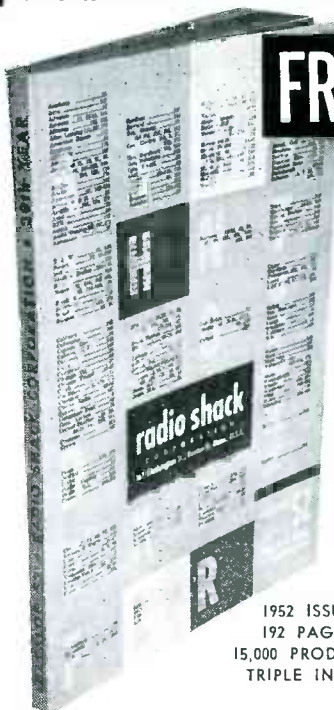

**FREE! RADIO SHACK AND
CHICAGO CATALOGS**

Please send me the catalogs checked below. I have indicated the quantity required in the box beside each catalog.

NAME _____
 COMPANY _____
 STREET _____
 CITY _____ STATE _____

- RADIO SHACK 1952 CATALOG
- CHICAGO NEW EQUIPMENT CATALOG
- CHICAGO TELEVISION CATALOG
- CHICAGO REPLACEMENT CATALOG
- CHICAGO MIL-T-27 DATA

**RADIO SHACK
CORPORATION**

167 Washington St., Boston 8, Mass.

1952 ISSUE
192 PAGES
15,000 PRODUCTS
TRIPLE INDEX

steatite, ceramic
& lava insulators



for
electrical
and
electronic
applications

Custom-molded, extruded or machined to close tolerances to meet your exact specifications. Prompt delivery at low cost on large or small orders. Over half a century of service is your guarantee of complete satisfaction.

FIND OUT TODAY. Illustrated bulletin with complete technical data will be sent on request.

M. KIRCHBERGER & COMPANY, INC.

Established
1890

1423 37th St., Brooklyn 18, New York • GEdey 6-1144
West Coast Representative:
S. Siegel, 1145 So. La Cienega Blvd., Los Angeles 35, Calif.

"HOLY MOSES...

**there's
something
I never knew
before!"**



F-11A

Unless you're exceptionally well-informed there are probably lots of things YOU never knew before right here in the advertising pages of this magazine. Alert manufacturers use these advertising pages to get the *news* about their products and services to you . . . quickly and effectively. Their advertisements contain information designed to help *you* do your job better, quicker and cheaper. To be well-informed about the latest developments in *your* industry . . . and to stay well-informed . . . *read all the ads too.*

Variable Frequency
**CENTRIFUGAL
BLOWER**

with
PERFORMANCE
that far
EXCEEDS
its
SIZE & WEIGHT

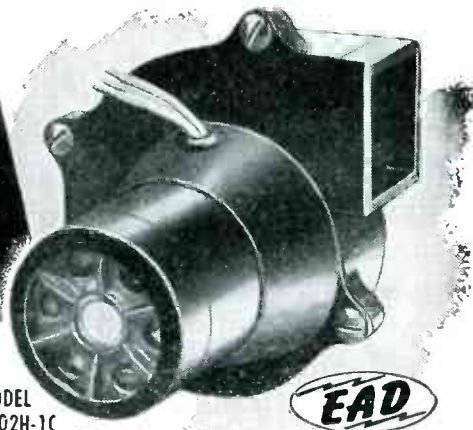

MODEL
B302H-1C

For aircraft or other confined area installations where weight and size are critical. Large cooling capacity — precision balanced for smooth operation at the higher frequencies.

SPECIFICATIONS

115 volts AC variable frequency • 320—1000 cycles • 1.4 amps. • 1.5 mfd. • 40 CFM minimum at 0" static pressure • overall dim. 4 3/8" x 4-13/64" • weight 25 oz. • Fungus proof • Silicon impregnated.

Other models available for greater air delivery. 60 cycle, 400 cycle variable frequency.

EASTERN AIR DEVICES, INC.

585 DEAN STREET • BROOKLYN 17, N. Y.

**McGRAW-HILL
PUBLICATIONS**



to speed up and simplify circuit probing in complicated radio and tv chassis. Eight inches long and made of polished hard rubber, the handles are fitted with short, sharp-pointed tips which minimize the possibility of short-circuiting of adjacent connectons. The flexible leads are of kinkless wire 48 in. long, have standard phone tips on their ends and can be used with practically all types of test instruments. List price is \$5.00.

Literature

Components Guide. Hudson Radio & Television Corp., 48 W. 48th St., New York 19, N. Y., has prepared a JAN cross-reference guide showing joint Army-Navy components and their commercial equivalents and also commercial-to-commercial equivalents. Listing thousands of items, it is expected to save purchasing agents and engineers hours of searching through individual catalogs for critically needed parts and supplies. The guide will be kept up-to-date by the publication of supplementary charts. Copies of the guide are available to persons writing on company stationery.

Servo Amplifier System. Brown Instruments Div., Minneapolis-Honeywell Regulator Co., Wayne and Windrim Aves., Philadelphia 44, Pa. Instrumentation data sheet 10.20-4 describes and illustrates the new high-gain type 40X servo amplifier system that produces motor drive from signals as low as 0.05 μ v. The application, operation and special design considerations of the new amplifier are discussed. Photographic and schematic illustrations are included.

Bridging Amplifier. Keithley Instruments, 3868 Carnegie Ave., Cleveland 15, Ohio, has released a 4-page bulletin describing the model 102 Phantom Repeater. The instrument discussed is a bridging amplifier with an extremely high input impedance and is used to increase the accuracy of vtvm's and oscilloscopes on high impedance circuits. The bulletin lists

TRANSICOIL

Servo

CONTROL MOTORS



Designed to Match Your Application Exactly

Each Transicoil control motor (and its gearing assembly and servo amplifier as well, where required) is specifically designed and produced to match both your electrical and mechanical requirements right down to the last detail. Costs are generally no greater than those of so-called "standard" types which may require costly adaptation or special handling on your assembly line. Available in 2-phase line operation or plate-to-plate types for either 60-cycle or 400-cycle operation and from fractions of a watt to 10-watts mechanical output.

**This handy control motor
data bulletin FREE!
Ask for Bulletin MC1**



TRANSICOIL CORPORATION

107 GRAND STREET, NEW YORK 13, N.Y.

See Us at the I.R.E. Show—Booth 229

SIGMUND COHN

Suppliers of GOLD PLATED
TUNGSTEN and MOLYBDENUM
GRID WIRE . . . and other Wire of

Smaller than Commercial Sizes

ANNOUNCE THE

**OPENING of a NEW PLANT
AT MOUNT VERNON, New York**



This new plant was constructed to provide ample space for long-planned expansion of our equipment, staff and production. Moreover it assures speedier service from all departments.

We will gladly send you a list of our products without obligation.

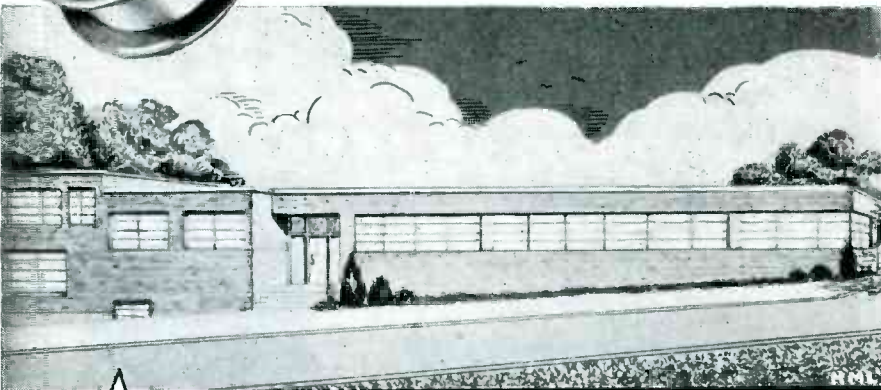

See Us at the
IRE SHOW
Booth 283

SIGMUND COHN CORP.
SIGMUND COHN MFG. CO., INC.
121 SOUTH COLUMBUS AVENUE
MOUNT VERNON, NEW YORK

complete specifications and includes diagrams of typical applications such as simultaneous measurements of voltage, shape inspection and aural monitoring with negligible loading of test circuits.

Steatite Ceramics. Stupakoff Ceramic and Mfg. Co., Latrobe, Pa., recently published the 52-page catalog No. 951 on steatite ceramic products. Included in the brochure are drawings and dimensions of principal steatite products such as tubing, coil forms, stand-offs, strains, assemblies, appliance parts, bushings and a variety of others. More than 500 parts are cataloged and photographs illustrate many of them. A special feature of the catalog is a chart that shows 18 technical characteristics of 14 of the company's typical ceramic products. Also included is a nine-page section devoted to the general standards for steatites and other electronic grade ceramics as adopted by Steatite Research Council.

Reliable Subminiatures. Raytheon Mfg. Co., 55 Chapel St., Newton 58, Mass., has issued a 22-page booklet on its line of reliable cathode-type subminiature tubes. Five types are shown, with application notes, complete description, mechanical and electrical data, characteristics and typical operation. Information concerning quality tests on reliable types is shown.

Technical Manual File. Grant-Jacoby Studios, 936 N. Michigan Ave., Chicago 11, Ill., has available for the asking a technical manual file. Developed primarily to aid prime contractors with technical manual procedure problems the file contains essential information on government and commercial technical manual preparation and cost procedures. A sample cost estimate form is included.

TV Control Replacement. Clarostat Mfg. Co., Inc., Dover, N. H., issued a manual in the Spring of '51 listing 343 set listings covering nearly 1,500 tv models, 105 standard controls with 5,705 applications and 222 RTV or exact-

duplicate controls with 3,451 applications. The new supplement will give a continuation of RTV numbers listing the manufacturer's part that they are used to replace. It lists by receiver manufacturer the frequency of use of the various controls.

Line Loss Chart. Newcomb Audio Products Co., 6824 Lexington Ave., Hollywood 38, Calif., has announced chart 101, a new wall chart of impedance mismatch and line loss versus line impedance and line length. Available free to sound specialists and audio installation engineers, it shows a comparison between the losses to be expected from long loudspeaker lines at voice coil impedances using various sized wires, and the commonly used higher impedance lines using conventional 18 gage wire.

Detector Comparator. Menlo Research Laboratory, Box 522, Menlo Park, Calif. A four-page brochure describes the various features and models of the Fluoretor, a portable single-unit ultraviolet generator, fluorescence tester and comparator combined. Specifications list the materials and exclusive design details that permit the unit to be used in broad daylight. Four types are cataloged. Also included is a full listing and description of the six sample holders and the Neoprene cone viewing accessory which makes possible the viewing of large surfaces with daylight excluded. Details are given on registration, guarantees and operating costs.

Varnished Insulation. Electro-Technical Products Division of Sun Chemical Corp., 113 East Centre St., Nutley 10, N. J., has available a booklet made up of data sheets dealing with varnished insulation for the electrical industry. Included are a classification, temperature limitations, and technical descriptions for a wide variety of insulating materials.

Crystal Sockets. E. F. Johnson Co., Waseca, Minn. A single-page bulletin covers three types of crystal sockets—the 126-105-1, designed for the HC-6/U crystal holder; the 122-223-2, for use with

* MAGNECORDER Sound Performance



...from **THE YUKON...TO THE WORLD!***

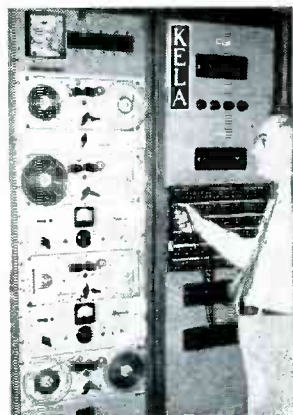

Magnecorder tape recorders penetrated the frozen northland on Exercise Sweetbriar (joint operation of U.S. and Canadian air and land forces). Operating perfectly at 30° below zero, Magnecorder recorders and amplifiers supplied the world with dramatic delayed programs from Alaska and the Yukon.

Stateside radio men also know the dependable performance of Magnecorders. One of the hundreds of stations relying on Magnecorders is KELA, Centralia-Chehalis, Washington, where delayed programs and "on locations" are handled with ease and confidence. Precision and fidelity make Magnecorders the first choice of radio engineers everywhere.

MORE FEATURES

PT7 accommodates 10½" reels and offers 3 heads, positive timing and pushbutton control. PT7 shown in console is available for portable or rack mount.

GREATER FLEXIBILITY

In rack or console, or in its really portable cases, the Magnecorder will suit every purpose. PT6 is available with 3 speeds (3¾", 7½", 15") if preferred.

HIGHER FIDELITY

Lifelike tone quality, low distortion, meet N.A.B. standards — and at a moderate price. PT63 shown in rack mount offers 3 heads to erase, record and play back to monitor from the tape while recording.



WRITE FOR NEW CATALOG
Magnecorder, INC.

360 North Michigan Avenue
Chicago 1, Illinois, Dept. EB-2

Send me latest catalog of Magnecorder equipment.



Name.....
Address.....
City..... Zone..... State.....



TELEX

LISTENING COMFORT

HEARING AT ITS BEST!

Modern, lightweight, durable—Telex Quality Headsets are easy on the ears . . . No uncomfortable ear pressure . . . Easily adjustable and built for hard usage . . . Telex Headsets effectively block out background noises . . . 5 ft. standard cord or special cord with built-in volume control . . .



C.A.A. Approved

TWINSET *

Nothing Touches the Ear

Weights only 1.6 oz.

MONOSET *

Direct Signal for Both Ears

Weights only 1.2 oz.



*Trademark

WRITE FOR FREE FOLDER—OR SEE YOUR PARTS JOBBER.

ELECTRO-ACOUSTIC DIVISION

DEPT. H-15, TELEX PARK, ST. PAUL 1, MINN.

In Canada, Atlas Radio Corporation, Toronto

STANDARD OF THE WORLD FOR QUALITY HEADSETS

DeJUR

PRECISION

Potentiometers

To meet the increasing demand for small compact precision potentiometers for Military airborne instrumentation and similar applications, DeJUR presents the L-400 Series featuring: 1 1/2" Diameter; 3 watts fully enclosed; 5 to 125000 ohms; 1% accuracy; linearity 0.25%; 300 mechanical and 278 electrical rotation; on-off switch available; multiple ganging; double end shafts available; meet JAN-R-19. Send us your requirements.

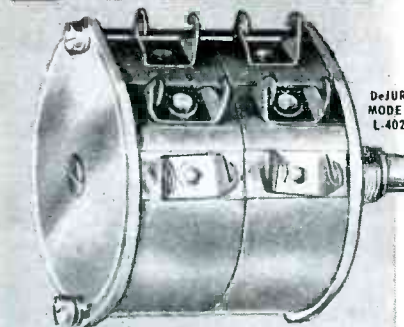

DeJUR MODEL L-402

SERIES L-400

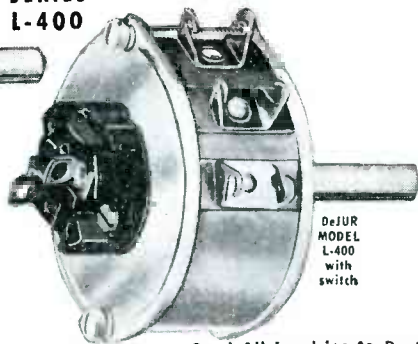

DeJUR MODEL L-400 with switch

Built to JAN-R-19 specifications. Other models from 1-3/16" to 5" diameter.



RA-60 DeJUR MODEL 275



RA-50 DeJUR MODEL 260



DeJUR MODEL 261



DeJUR MODEL 292

Send All Inquiries to Dept. E2



DeJUR

AMSCO CORPORATION

45-01 NORTHERN BOULEVARD, L. I. C. 1, N. Y.

MANUFACTURERS OF SCIENTIFIC PRECISION EQUIPMENT FOR OVER A QUARTER OF A CENTURY
• CAMERAS • PROJECTORS • ENLARGERS • EXPOSURE METERS •

For:

**RF SHIELDING
RADAR REFLECTION
MASSIVE SURFACE
CONDUCTIVITY**

Investigate

M. SWIFT & SONS
metallized textiles

For further information write:

M. SWIFT & SONS
Engineering Department
10 Love Lane
Hartford 1, Conn.

Ideal for
ANTENNA CONNECTIONS
PHOTO-CELL WORK
MICROPHONE CONNECTIONS

JONES SHIELDED TYPE PLUGS & SOCKETS

LOW LOSS PLUGS AND SOCKETS FOR HIGH FREQUENCY CONNECTIONS. SUPPLIED IN 1 AND 2 CONTACT TYPES:



P-101-1/4

101 Series can be furnished with 1/4", .290", 5/16", 3/8" or 1/2" ferrule for cable entrance. Knurled nut securely fastens unit together. Plugs have ceramic insulation and sockets have bakelite. Quality construction. Fine finish. Assembly meets Navy specifications.

For full details and engineering data ask for Jones Catalog

No. CS-18.

JONES MEANS Proven QUALITY

S-101

Jones HOWARD B. JONES, DIVISION
CINCH MANUFACTURING CORPORATION
CH. CAGO 24, ILLINOIS
SUBSIDIARY OF UNITED-CARR FASTENER CORP.

HC-5/U crystal holder; and the 126-120-1 multiple crystal holder that accommodates up to ten FT-243 crystals. Descriptions and dimensional drawings are given.

Oscillographs and Amplifiers. Rahm Instruments Inc., 12 West Broadway, New York 7, N. Y. Bulletin R1052 gives illustrations, applications and structural and performance characteristics of the type RO recorders and type OB amplifiers. The direct recording oscillographs and associated amplifiers described are designed to provide the optimum in linearity and frequency response characteristics while maintaining versatility of application and structural ruggedness.

Crystal Manufacture. The James Knights Co., Sandwich, Ill., has available a one-hour color film showing the step-by-step manufacture of crystals. The 16-mm silent motion picture film records in dramatic detail the processing of crystals from raw quartz through x-raying, testing, mounting and calibrating to bring them up to final precision standards. The film may be obtained by interested groups and associations.

Step-Motor Impulse Counter. General Electric Co., Schenectady 5, N. Y. The single-page bulletin GEC-829 gives an illustrated description of a new step-motor impulse counter for counting at intermediate rates. The unit discussed provides accurate counting from 0 to 60 counts per second and is especially useful in radiation counting. Chief features and technical specifications are included.

Solder Seal Bushings. T. C. Wheaton Co., Millville, N. J., has published a single-sheet bulletin illustrating and describing its 1300 series of Tronex-solder seal terminals. In addition to the latest specifications applicable to the 1300 series, the leaflet contains many valuable suggestions and recommendations on the use of metallized glass type, soldered seal terminals.

Instruments Catalog. Kay Electric Co., 14 Maple Ave., Pine Brook, N. J. The new and revised illus-

We may KNOCK YOUR HAT OFF

with our Quote on
SAVINGS and DELIVERY

If you're a Big User of Tiny Parts Such as These!



Sound like exaggeration? Not when you know that the electronic tube industry looks to The Bead Chain Mfg. Co. for its millions of radio tube pins, jacks and sleeves required in tremendous quantities.

For pin-like parts, and variations of bushings needed for mechanical purposes, as well, we are the money-saving supplier to scores of famous makers of products like toys, business machines, appliances, ventilators.

You save . . . if we can make it! We can almost say with certainty that if we can make that part (up to 1/4" dia. and to 1 1/2" length) you use in large quantities, we can show you a big saving. And, assure on-time deliveries to meet your defense work schedules! We have something unique back of that claim . . .

Nobody has What We Have! To be able to produce our famous Bead Chain to sell for pennies per yard, we had to develop *our own* equipment and method . . . our Multi-Swage Method.

Instead of turning and drilling parts from solid rod, or stamping and forming them, our Multi-Swage Method automatically swages them from flat stock into precision tubular forms, with tight seams. By increasing the production rate many times and eliminating scrap, this saves a large part of the cost by other methods.

What We Can Make. Parts may be beaded, grooved, shouldered, and of most any metal. Generally, should not exceed 1/4" dia. or 1 1/2" length. Catalog shows many *Standard Items* available in small quantity. *Special Designs* must usually be ordered in lots of a half-million or more, unless they are frequently re-ordered.

Get Cost Comparison. Send blueprint or sample and quantity requirements. We will return an eye-opener on economy.

Low Cost Way to Get Parts for Many Mechanical Uses

Shaft bearings—Foot or rest pins
—Spacers between parts—Shoulder pins for permanent attachments.



Let BEAD CHAIN make it by MULTI-SWAGE METHOD



I want this
Catalog — Data Folder

The Bead Chain Mfg. Co.
88 Mountain Grove St., Bridgeport, Conn.

Name, title.....
Company.....
Address.....



PRECISION POTENTIOMETERS

SINUSOIDAL TYPE

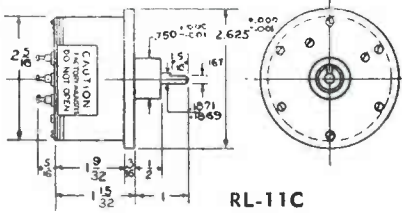

RL-11C

CONDENSED SPECIFICATIONS

	RL 11-C	RL 14-MS
Total resistance	16,000 ± 10%	35,400 ± 1%
Percent resistance within brush circle	Approx. 85%	99 ± 1/4%
Angle of rotation	360°	360°
Weight	4.75 oz.	1.8 lbs.
Torque (Approximate)	3/4 oz. in.	2 oz. in.
Wire	80 Ni 20 Cr	80 Ni 20 Cr
Resolution	.4°	.2°
Angular accuracy	±.6°	±.5°
Amplitude accuracy	±.8%	±.6%
Maximum volts across winding	150	350
Maximum speed	60 rpm	60 rpm
Expected Life	350,000 cycles	200,000 cycles

Illustration shows RL-11C unit, RL-14MS unit is approximately twice as large. Minor variations of these standard designs, available on special order, permit operation at high rotational speeds with some loss of accuracy but, with a substantial increase in expected life. Sine and cosine voltages are produced simultaneously. Resistances other than those shown above are available within certain limits.

FOR COMPLETE DETAILS SEND FOR BULLETIN F-68-A



THE GAMEWELL COMPANY
NEWTON UPPER FALLS 64, MASSACHUSETTS

electronics BUYERS' GUIDE

is the ONE BOOK

THE ONLY ONE OF ITS KIND

in which design engineers and purchasing agents will find a complete, accurate, and up-to-date list of the manufacturers of all types of electronic and allied products . . . components and complete equipment.

*

Keep it handy for ready reference throughout the year.

*

When buying or requesting product information from it be sure to mention it.

PIX

WIRE FORMING SPECIALISTS

Precision Parts to meet your Production and Engineering needs. From .002" dia. to .125" dia. Radio tube parts—Stampings—Drawings Modern facilities, high-production equipment.

Metal Crystal Holder Parts
Send sketch or print for quotation.

PIX MANUFACTURING CO., Inc.
24 Bedford St., Newark 3, N. J.

Little thought-of facts about capacitors

The short time breakdown voltage of a well-made D.C. capacitor is not less than 5 to 8 times the actual working voltage at 20°—

$$E = 5 \times e \text{ min.}$$

E = Breakdown voltage
e = Rated d.c. working voltage

INDUSTRIAL CAPACITORS are unvaryingly held to this formula.

Designed for maximum safety and the smallest possible volume, INDUSTRIAL CAPACITORS are the most widely used capacitor in industrial applications.

WRITE TODAY FOR DETAILED CATALOG

INDUSTRIAL CONDENSER CORP.



Watch this space for other capacitor facts that will help you.

Sales Offices in All Principal Cities
3243 N. California Ave.
Chicago 18, Illinois

trated catalog B-51-52 includes in its table of contents: ordering information; price list and index; high-frequency test equipment; speech, subaudio and audio-frequency analysis equipment; industrial instruments; production and service test equipment; and several pages of accessories and components. Also shown is a lineup of engineering representatives with their addresses.

Steatite Standoff Insulators. Thor Ceramics, Inc., 225 Belleville Ave., Bloomfield, N. J. A complete line of standard steatite standoff insulators for electronic and high-frequency equipment are illustrated and fully described in catalog 151. Complete with full engineering data, specifications and dimensional drawings, the 4-page catalog covers the company's insulators that are made to conform to government and commercial specifications.

Magnetic Tape Recorder. Audio & Video Products Corp., 730 Fifth Ave., New York 19, N. Y., has issued a 4-page brochure describing the Ampex model 307 three-speed magnetic tape recorder with frequency response out to 100,000 cps. The unit discussed is primarily designed for telemetering, data recording, vibration studies, shock analysis and other such special recording work which is found in the fields of scientific and military research. The back page of the brochure also describes the Ampex model 375 60-cycle tuning fork amplifier which provides a source of accurate 60-cycle power which is intended to drive the capstan motors of any Ampex tape recorder to that tape speed will be entirely independent of power line frequency variations.

Relay Catalog. American Relay & Controls, Inc., 4939 W. Flournoy St., Chicago, Ill. Attractively printed in two colors, the new catalog contains 12 pages of information valuable to relay users. It includes a section on the selection of relays, giving the method and data required to choose a relay for any specific application. The catalog also describes the complete line of Amrecon relays, with illustrations and data on ten basic

Now, more than ever... YOU NEED THIS INFORMATION

You'll find these bulletins particularly helpful when selecting or specifying magnetic components for any military or commercial application. Send for them today.

RAYTHEON

VOLTAGE STABILIZERS

This new bulletin provides the application data, performance facts, operating characteristics, graphs and detailed specifications you need to specify a voltage stabilizer for any electrical or electronic product. Raytheon Voltage Stabilizers are available in a wide range of catalog types or custom-engineered to suit special needs.

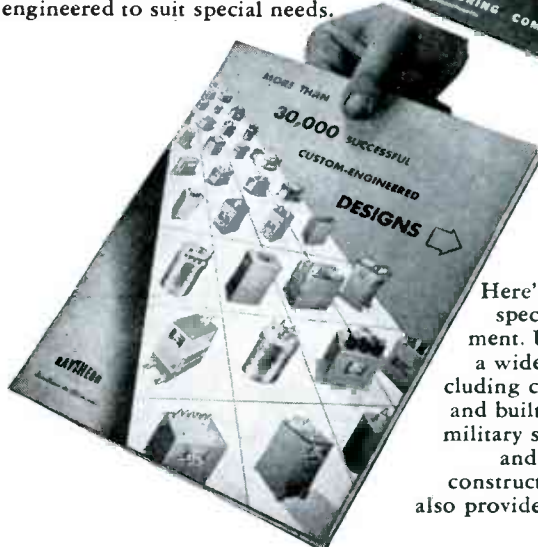

RAYTHEON

CUSTOM BUILT TRANSFORMERS

Here's the help you need in visualizing special transformers for your requirement. Units illustrated are selected from a wide range of types and capacities including chokes and transformers designed and built to government specifications for military service. Data includes dimensions and VA ratings of all frequently used construction types. Time-saving forms are also provided to help you specify your needs.

Raytheon products include Submarine Signal Fathometers*, Mariners Pathfinder* Radar, Marine Radio Telephone, Raytheon Television Receivers, Tubes, Weldpower* Welders, RectiChargeR* Battery Chargers, RectiFilter* Battery Eliminators, Microtherm* Diathermy, Sonic Oscillators, Standard Control Knobs, and other electronic equipment. *Reg. U. S. Pat. Off. ©



RAYTHEON MANUFACTURING COMPANY

Sales Equipment Division, Dept. A
Waltham 54, Massachusetts

Please send me your Voltage Stabilizer and Custom-Built Transformer Bulletins.

Name

Position

Company

Address

City..... Zone..... State.....

FOR YOUR PANEL

A NOVEL and UNIQUE CIRCUIT INDICATOR

DESIGNED FOR NE-51 NEON LAMP

For 110 or 220 volt circuits

The required resistor is an integral part of this assembly — "built-in."

**RUGGED • DEPENDABLE
LOW IN COST**



PATENTED: No. 2,421,321
Cat. No. 521308-997

DIALCO



WILL YOU TRY A SAMPLE?

Write on your company letterhead. We will act at once.
No charge, of course.

SEND FOR THE 192 PAGE HANDBOOK OF PILOT LIGHTS

Among our thousands of Pilot Light Assemblies there is one which will fit your special conditions. Many are especially made and approved for military use. We pride ourselves on prompt deliveries—any quantity.

ASK FOR OUR APPLICATION ENGINEERING SERVICE

Foremost Manufacturer of Pilot Lights

The DIAL LIGHT COMPANY of AMERICA

900 BROADWAY, NEW YORK 3, N. Y. SPRING 7-1300



Mc GRAW-HILL
DIRECT MAIL LIST SERVICE

MAILING LISTS THAT WORK...

McGraw-Hill Industrial Mailing Lists are a direct route to today's purchase-controlling executives and technicians in practically every major industry.

These names are of particular value now when most manufacturers are experiencing constantly increasing difficulty in maintaining their own lists.

Probably no other organization is as well equipped as McGraw-Hill to solve the complicated problem of list maintenance during this period of unparalleled changes in industrial personnel. These lists are compiled from exclusive sources, based on hundreds of thousands of mail questionnaires and the reports of a nation-wide field staff, and are maintained on a twenty-four hour basis.

Investigate their tremendous possibilities in relation to your own product or service. Your specifications are our guide in recommending the particular McGraw-Hill lists that best cover your market. When planning your industrial advertising and sales promotional activities, ask for more facts or, better still, write today. No obligation, of course.

**McGraw-Hill
Publishing Co., Inc.**

DIRECT
MAIL
DIVISION

330 WEST 42nd STREET
NEW YORK, 36, N. Y.

Eliminate CRYSTAL TEMPERATURE CONTROL COSTS . . .

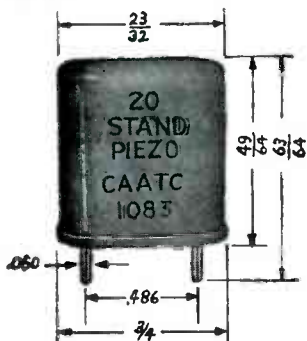

Now you can forget temperature control. Just specify Standard's Type 20 Crystal Unit for your products.

In addition to lowering power requirements and weight, it increases compactness, durability and dependability. Type 20 meets all Government specifications, too.

Discover how the Standard Type 20 can cut costs and increase sales for you. A letter will bring Engineering data and complete details by return mail.

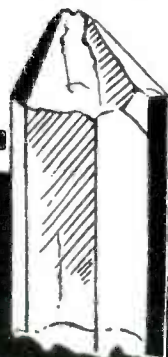

**Standard Piezo
COMPANY**
CARLISLE, PENNSYLVANIA

models (including both a-c and d-c types) and their many variations. Also discussed are snap-action and latching relays; screw-terminal type relays; plug-in mountings; and hermetically sealed models.

Output Transformer Chart. Standard Transformer Corp., 3580 Elston Ave., Chicago 18, Ill. The No. 375 output transformer chart lists 129 of the most frequently used output transformers and the tubes with which they should be used. This handy guide simplifies the selection of the proper transformer for use as replacement in radio receivers or in the construction of audio amplifiers. In almost all cases more than one transformer is listed so that there is a choice of mounting types, and the application, class and operating characteristics of the tube and transformer are shown in ready reference form.

Glass-to-Metal Hermetic Seals. The Sealtron Co., 9701 Reading Road, Cincinnati 15, Ohio, has issued a new 4-page general bulletin with pictures and specifications of hermetic seals and subassemblies. Twenty-five sales representatives in major cities from coast to coast are also listed with their addresses and phone numbers.

Precision Potentiometers. The Gamewell Co., Newton Upper Falls 64, Mass., has available an 8-page bulletin dealing with a line of precision potentiometers. It is completely illustrated and contains technical specifications and applications. A full page of ordering and pricing information is included.

Capacitors and Filters. Astron Corp., 255 Grant Ave., East Newark, N. J., has published catalog AC-3 offering educational information on performance data and test characteristics that should prove helpful to all users of capacitors and filters. Listed and illustrated are the comprehensive line of dry electrolytic capacitors, along with all applicable engineering data. The Metalite section features, in addition to pertinent data, a history of the

Stands up under **HEAT!**



JUST LIKE **Permacel** ELECTRICAL TAPES!

FOR TOUGH PRODUCTION JOBS you can depend on **PERMACEL** Electrical Tapes to do the job better—at lower cost. Here's why:

PERMACEL Electrical Tapes

1. Provide a wide safety factor in your bake oven. In many cases, you can use them in place of special thermosetting tapes.

2. Assure greater heat stability, thus reducing manufacturing errors and lowering production costs.

3. Offer real pressure-sensitive qualities. They reduce wire "pop-ups," keep your need for "specials" at a minimum and thus cut down inventory.

PERMACEL Electrical Tapes mold easily, have "quick-stick," high tensile strength and are tough enough to hold heavy wires. For complete facts and figures, mail the handy coupon below.

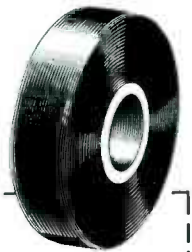

PERMACEL Electrical Tapes
Industrial Tape Corp., New Brunswick, N. J. Dept. 4F

CHECK ONE OR BOTH:

- Please have a representative call to explain in detail the heat stability characteristics of **PERMACEL** Electrical Tapes. Place me on your mailing list.

COMPANY NAME.....

STREET.....CITY.....ZONE.....STATE.....

YOUR NAME.....TITLE.....

INDUSTRIAL TAPE CORPORATION, NEW BRUNSWICK, N. J.

Makers of **TEXCEL** Cellophane Tape, and a complete line of pressure-sensitive tapes for industry.

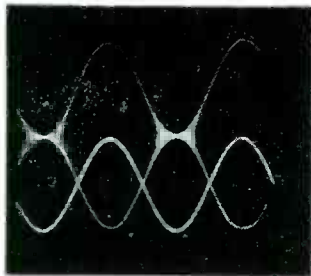

320 kc modulated 400 cps; audio on second beam.

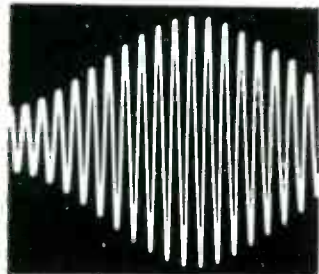

24 kc modulated 60% 1 kc.

We shall be pleased to see you at the
I. R. E. CONVENTION
BLOCK 137

100% MODULATION



. . . A.M. WITHOUT F.M.

Excellent amplitude modulation is a feature of the Standard Signal Generator TF 867—*a.m.* accompanied by minimum spurious *f.m.*—less than 100 cps below 5 mc, 1,000 cps above. Other features are:

Wide range—15 kc (or less) to 30 mc in 11 bands on full vision scale. **Crystal accuracy**—0.01% 1 mc harmonic source built-in. **Easy tuning**—discrimination 1 part in 10,000 on total 15 ft. scale length. **High output**—4 volts down to 0.4 microvolts. Flexible modulation—internal 400 and 1,000 cps. 0-100%, external 50-10,000 cps \pm 2db.

MARCONI INSTRUMENTS 23-25 Beaver Street, New York

CANADA: CANADIAN MARCONI CO., MARCONI BUILDING, 2442 TRENTON AVENUE, MONTREAL
ENGLAND: MARCONI INSTRUMENTS LIMITED ST. ALBANS, HERTS.

SYNTRON

SELENIUM RECTIFIERS

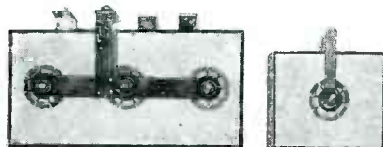

Made by a new process to a uniform, high quality for continuous, heavy-duty service.

1" sq. to 12" x 16" cells—in stacks, or single cells for customer assembly.

Write for literature

SYNTRON CO.
241 Lexington
Homer City, Pa.



air system sockets



Vacuum Tube Accessories
By Eimac — Now Available!

Designed primarily to simplify and increase the efficiency of cooling the most popular Eimac tetrodes. Sockets are supplied with necessary mounting screws, clips, and a pyrex glass chimney. The 4X150 socket, in addition, incorporates a built-in screen to cathode by-pass capacitor.

• Write for new Eimac Catalogue Summary showing Eimac tubes and other accessories.



EITEL-McCULLOUGH, INC. · San Bruno, Calif.

ELECTRONICALLY REGULATED LABORATORY POWER SUPPLIES



- STABLE
- DEPENDABLE
- MODERATELY PRICED
- MODEL 28 STANDARD RACK MOUNTING
- PANEL SIZE 5 1/4" x 19"
- WEIGHT 16 LBS.
- **INPUT:** 105 to 125 VAC, 50-60 cy
- **OUTPUT #1:** 200 to 325 Volts DC at 100 ma regulated
- **OUTPUT #2:** 6.3 Volts AC CT at 3A unregulated
- **RIPPLE OUTPUT:** Less than 10 millivolts rms

For complete information write for Bulletin E



LAMBDA ELECTRONICS CORPORATION
CORONA NEW YORK

use of metallized paper in capacitors; advantages of their self-healing property, subminiature size and light weight; and engineering performance data, curves and test procedures. The newly developed type AQ capacitors, for operation at 125 C without derating, are presented; and r-f interference filters are listed and illustrated, with drawings, attenuation charts and other design aids.

Calibrating Standard. Radio Wire Television Inc., 100 Sixth Ave., New York 13, N. Y. A two-page bulletin deals with the type 300 oscilloscope calibrating standard. Mechanical specifications, illustration, chief use and features are given. By the standard described complex waveforms and parts of such waveforms can be measured quickly and separately. The unit discussed, connected between the equipment being tested and an oscillograph, provides a source of calibrating voltages ranging between 0.001 and 100 v that can be displayed on the screen by simply turning a knob.

Nuclear Instruments. El-Tronics, Inc., 2647 N Howard St., Philadelphia, Pa., offers a catalog listing data on their line of nuclear instruments used for the detection and count of all types of nuclear radiation. The instruments described are used by hospitals, industrial laboratories and civilian defense. A free copy may be obtained on request for bulletin A1150.

Metallic Rectifiers. Radio Receptor Co., Inc., 251 W. 19th St., New York 11, N. Y. Totalling 16 pages and cover, the thoroughly illustrated article with application photographs, drawings, diagrams, and charts, reviews the background of metallic rectifiers and clarifies the various factors in their application to electronic circuits. It is of value not only to the novice, but to the engineer with specialized experience in the field. Also included is a helpful glossary of terms.

Tantalum Electrolytic Capacitors. P. R. Mallory & Co., Inc., Indianapolis 6, Ind. A recent four-page folder gives illustrations and technical information on the type XT

FEDERATED

nation's leading **JAN** source

5 great stock-piles,
strategically located,
offer unsurpassed source
for JAN component parts

Federated Purchaser, Inc. makes available to industrial electronics users innumerable in-stock JAN electronic materials for immediate shipment.

Convenient warehousing of thousands of other items in the five key industrial areas, for prompt shipment to any part of the country, makes it possible for you to reduce your warehousing, decrease depreciation costs and to purchase economically.

Our experienced engineering staff will interpret requirements from your blueprints and offer advice on substitutes or interchangeability of parts.

Take advantage of our complete stocks, our unique service—Make Federated your one source of supply!

WRITE for "Mr. Fed", Federated's monthly electronic equipment newsletter, containing latest JAN information, new products, new techniques, new economies. Write on your letterhead to Dept. E-2.

VISIT BOOTH NO. 473
AT THE I. R. E. SHOW

Federated Purchaser
INCORPORATED

THE ONLY COAST TO COAST ELECTRONICS DISTRIBUTOR

New York City
66 Dey St.
Dlgy 9-3050

Los Angeles
911 S. Grand Ave.
TRinity 7311

Newark, N. J.
114 Hudson St.
Market 3-9035

Allentown, Pa.
1115 Hamilton St.
Phone 3-7441

Easton, Pa.
925 Northampton St.
Phone 4259

TELETYPE: NY1-2859 (New York, N. Y.) • LA-572 (Los Angeles, Cal.) • AN-22 (Allentown, Pa.)

P M SMALL METAL STAMPINGS

PATTON-MacGUYER

For over 33 years P-M has been a dependable source for small metal stampings. An extensive modern plant, complete equipment, specialized engineering experience and toolmaking skill combine at P-M to produce stamped metal parts accurately, economically, promptly. Moderate die charges, Modern facilities for large volume production. Special stamping problems are gladly accepted; recommendations for the most efficient and economical solutions are made promptly. Send prints for your next stamping job to P-M.

TERMINALS for ELECTRIC WIRES

Being long experienced specialists in the terminal field, we have dies to produce over 400 different kinds of separate terminals, and every modern facility to meet your standard or special requirements. We also provide terminals in continuous form, supplied on reels, with machine for attaching and soldering tandem terminals to wires in one continuous operation. Send for folder.

PATTON-MacGUYER COMPANY

EDGEWOOD STATION, PROVIDENCE 5, R. I.

THE NEW 6T-4



PRECISION STROBOSCOPIC
FREQUENCY METER

MEASURES FREQUENCIES
INSTANTLY
BY PURELY VISUAL MEANS!



ACCURATE TO 0.05%

FILL IN AND MAIL TODAY
for FREE Literature

C. G. CONN Ltd.
Electronics Division, Elkhart, Ind.
Department 212

Send me descriptive literature on
NEW 6T-4 STROBOCONN.

Measures transient vibrations. Finds precise speed of rotating mechanical parts. Calibrates or checks precision tachometers, oscillators, other pulse generators. Used in place of bridge methods in measuring inductance and capacitance. Many other uses.

MAIL COUPON FOR COMPLETE
INFORMATION . . . SEE HOW
STROBOCONN CAN HELP YOU!

Name _____

Street _____

City _____ State _____

ENGINEERS • SCIENTISTS
• TECHNICIANS •

ARMOUR RESEARCH FOUNDATION

of

ILLINOIS INSTITUTE OF TECHNOLOGY

URGENTLY NEEDS TOP LEVEL ENGINEERS
AND SCIENTISTS FOR ITS EXPANDED RE-
SEARCH AND DEVELOPMENT ACTIVITIES.

Electronic engineers with experience or advanced training in antennas, microwave, television or general communications work.

Electronic engineer for general circuit work on instrumentation for medical, meteorological and industrial applications.

Engineer with training and experience in servo-mechanisms, including systems analysis, network synthesis and instrumentation for flight simulators, fire control systems and industrial control applications.

Engineer with experience in electronics and/or electromechanical design for research and development in the magnetic recording field.

Engineer with experience in development of electromechanical or electromagnetic devices such as small motors, relays, and transformers.

Engineer or physicist interested in precision electrical measurements, electrical insulation or arc interruption problems. Prefer man with advanced training or equivalent experience.

Electronics or electrical engineering technicians for work as laboratory assistants in development of prototype models of equipment. Prefer men with trade school training or equivalent experience.

ARMOUR RESEARCH FOUNDATION SERVES
INDUSTRY AND GOVERNMENT IN RESEARCH
AND DEVELOPMENT COVERING THE FIELDS
OF SCIENCE AND ENGINEERING. WORK IS
STIMULATING AND OFFERS DIVERSIFIED AC-
TIVITY AS WELL AS WIDE CONTACT IN
PROFESSION AND INDUSTRY. POSITIONS
DESCRIBED OFFER OPPORTUNITIES FOR
PROJECT LEADERSHIP IN IMPORTANT NEW
FIELDS OF RESEARCH. SALARIES OPEN FOR
DISCUSSION AND WILL BE COMMENSURATE
WITH TOP LEVEL CAPABILITIES REQUIRED
FOR THESE POSITIONS.

Write for descriptive brochure of the Foundation.
Interviews will be arranged. Address inquiries to:

ASSISTANT DIRECTOR for PERSONNEL
ARMOUR RESEARCH FOUNDATION OF
ILLINOIS INSTITUTE OF TECHNOLOGY

35 West 33rd Street
Chicago 16, Illinois

Runzel

WIRE, CORD and CABLE

SOLVE YOUR WIRING PROBLEMS

In almost endless variety of colors, sizes and specifications to your order, Runzel products will assist you in your wiring problems.

Shielded wire and cords . . .
popular hook-up and lead-in wire
. . . speaker cords and all types of
insulated wire products.

Geared for fast production . . .
Centrally located . . . our facilities
for service are unexcelled.

Write for samples.



RUNZEL CORD & WIRE CO.
4723 Montrose Avenue
Chicago 41, Illinois

tantalum electrolytic capacitors for extreme temperature electronic applications. Dimensional and mounting data and electrical characteristics are found therein.

Braze-Clad Metals. American Silver Co., Inc., 36-07 Prince St., Flushing 54, N. Y., has issued a 4-page bulletin designated as BC-51 that gives useful technical information relative to Braze-Clad metals and also suggests applications where they can be profitably used. Description and a possible engineering service are included.

Connector Handbook. Cannon Electric Co., P. O. Box 75, Lincoln Heights Station, Los Angeles 31, Calif., recently published a 32-page pocket-size service manual on using the AN-M connector—a vibration proof and pressurized connector for aircraft, radar, instrument and general electrical applications. Presented in a 2-color, varnished, plastic-bound cover, bulletin SIM-1 uses 44 illustrations giving detailed instructions for installation, inspection, disassembly and reassembly operations.

Screen Booth Filters. Tobe Deutschmann Corp., Norwood, Mass. In response to stepped-up wartime demand for its line of electronic interference filters, the company has instituted a major revision of its entire catalog. First section off the press is catalog 201—Screen Booth Filters. Other sections on the complete line of filters, capacitors and electronic devices will follow shortly.

Photoelectric Colorimeter. Photovolt Corp., 95 Madison Ave., New York 16, N. Y., has available the 20-page bulletin No. 420 on the Lumetron photoelectric colorimeter, model 402-E. The bulletin has been completely revised and enlarged by the description of a number of recently developed accessories. Illustrations and price lists are included.

Miniature Transformers. Triad Transformer Mfg. Co., 2254 Sepulveda Blvd., Los Angeles 64, Calif. Highlighting the trend toward



FLUOROFLEX[®]-T gives you "Teflon"* with optimum chemical, electrical, thermal and physical properties, in rod, sheet, and machined parts

Here is Teflon produced under rigid control, in new equipment expressly designed by Resistoflex to bring out utmost inertness and stability in this material. You get Teflon with maximum tensile strength, "plastic memory," flexibility. Sheets are flat—easier to handle. Rods are uniform—machine properly. Parts are free from internal strains, cracks or porosity.

Fluoroflex-T withstands -90°F to $+500^{\circ}\text{F}$ continuous service. Chemically, it's essentially inert. It is non-adhesive and has little friction. Electrically, it is virtually the perfect insulator for ultra high frequencies.

We'll gladly consult with you on your application. Fluoroflex-T rods are available from $\frac{1}{4}$ " to 2" diameter; sheets 21" x 21" in $\frac{1}{16}$ " to $1\frac{1}{2}$ " thicknesses; machined parts to specification.

® Resistoflex reg. trade mark for its products made from fluorocarbon resins.
*Du Pont's trade mark for its tetrafluoroethylene resin.

*For out of the ordinary
engineering with synthetics*

RESISTOFLEX

RESISTOFLEX CORPORATION, Belleville 9, N. J.

SEND NEW BULLETIN containing technical data and information on Fluoroflex-T rod, sheet and shapes

NAME..... TITLE.....

COMPANY.....

ADDRESS.....

E2

WHAT'S NEW?



PERMO POTTING & SEALING COMPOUNDS

DEFINITELY SUPERIOR! FOR PERMANENT PROTECTION

Make no mistake! This is no ordinary tar. For special high electrical resistance where retention of viscosity over wide temperature ranges is necessary, PERMO POTTING & SEALING COMPOUNDS give the highest electrical insulation and water repellency. Seldom has a new product received such enthusiastic reception, especially in the electronics field where requirements are highly exacting.

SUPERIOR FOR CASTING & SEALING • ELECTRONIC PARTS • BATTERIES • TRANSFORMERS • COILS • A WIDE VARIETY OF ELECTRICAL PARTS

USED IN ARMED SERVICES EQUIPMENT

FREE PROVE IT YOURSELF SAMPLE

A sample will do more to convince you quickly than any claims we can make. No obligation. Send for yours now. And if you have a potting or adhesive problem, let our skillful laboratory staff solve it for you. No problem too large or too small.

Since 1906



H. V. HARDMAN CO.
INCORPORATED
571 CORTLANDT STREET
BELLEVILLE 9, N. J.

- Adhesives of All Types • Brush & Industrial Cements
- Depolymerized Rubbers • Potting Compounds

miniaturization and elimination of weight for use in military equipment, bulletin 451 announces the addition of miniature transformers for portable equipment, voice frequency audio components, power transformers, filament transformers and filter reactors. Described is the use of the 380 to 1,500-cycle line frequencies for power equipment that permits notable reduction in size of transformers and reactors. New developments in core materials and new winding and impregnating techniques that permit further reduction are covered.

Low-Pressure Cells. Baldwin-Lima-Hamilton Corp., Philadelphia 42, Pa., presents in bulletin 326 two pages of information on the type SR-4 low-pressure cells of 0-10 to 0-100 lb-per-sq-in. capacity for measuring variations in gas or liquid pressures. The bulletin includes illustrations of the cells, wiring diagram, dimensional diagrams and specifications.

Testing & Measuring Equipment. General Electric Co., Schenectady 5, N. Y. A new 80-page catalog summarizes for the first time under one cover all of the company's testing and measuring equipment for laboratory and production line use. To be used primarily as a reference to the apparatus available for the complex measurements to be made in industry, catalog GEC-1016 contains more than 150 photographs and diagrams and describes the uses, features, specifications and prices of more than 130 testing and measuring equipments. The booklet also contains publication references to company bulletins that describe each device in more detail.

Nickel-Free Ferrites. Ferroxcube Corp. of America, 50 E. 41st St., New York 17, N. Y. New data on improved nickel-free ferrite cores for coils and transformers used in tv and electronics are contained in engineering bulletin FC-5101-A. The bulletin contains performance curves for the type 3C series of cores, which have improved



On the job!

Our volunteer speakers are saving thousands of lives today . . . in factories and business offices . . . at neighborhood and civic centers . . . at social, fraternal and service group meetings all over this land . . . by showing people what they can do to protect themselves and their families against death from cancer.

To find out what you yourself can do about cancer, or if you want us to arrange a special educational program for your neighbors, fellow-workers or friends, just telephone the American Cancer Society office nearest you or address a letter to "Cancer," care of your local Post Office. One of our volunteer or staff workers will be on the job to help you.

*American
Cancer
Society*



MICO ENGRAVERS

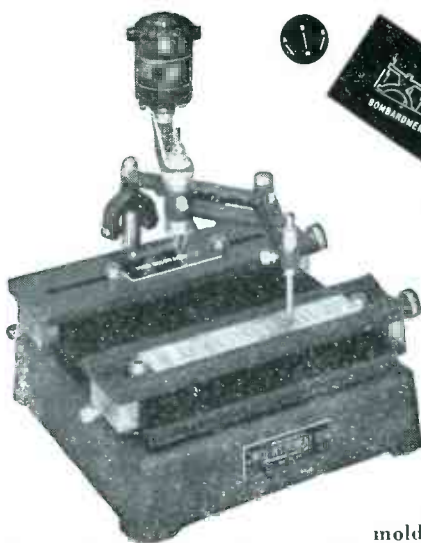

An accurate, inexpensive and portable machine for engraving name plates and panels, forming small molds and dies, and profiling small parts. Geometrically correct for true three dimensional work. Accurately duplicates master copy in metals, plastics or wood. Rugged, sturdy construction.

COMPARE THESE SUPERIOR FEATURES.

- Engraves in 2 or in 3 dimensions.
- Pantograph permits 4 reduction ratios.
- Micrometer depth control graduated in thousands of an inch.
- High speed, ball bearing spindle.
- Chuck $\frac{1}{8}$ " to take variety of small tools, burrs, mounted points as well as standard cutters.

Send for Illustrated Catalog

MICO INSTRUMENT COMPANY
76 E. Trowbridge St. Cambridge, Mass.

distributors for 30 years
of radio and electronic
components for all your needs

RADIO WIRE TELEVISION

INCORPORATED

NEW YORK 13, N. Y.

100 Sixth Avenue
WALKER 5-8883

NEWARK 2, N. J.

24 Central Avenue
MARKET 2-1661

BOSTON 10, MASS.

110 Federal Street
HUBBARD 2-7850

Lafayette 100 SIXTH AVE.
DIV. RADIO WIRE TELEVISION, INC.

FOR CUSTOM RADIO AND TV COMPONENTS

Custom assemble your own high fidelity phono - radio - television ensemble. All famous name components at lowest prices. Send for Free hi-fi catalog to Dept. E.



**FABRICATED PARTS FOR
INDUSTRY'S TOUGHEST JOBS**

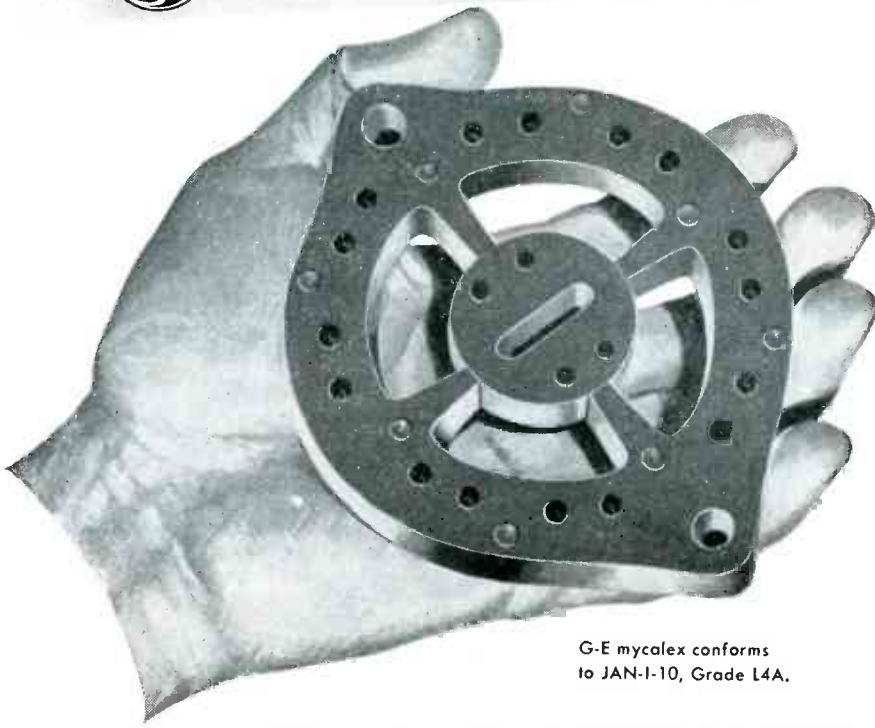

G-E mycalex conforms
to JAN-I-10, Grade L4A.

Specify G-E MYCALEX for tough electronic jobs like this

This rotor-and-stator assembly for an electronic "gang switch" had to fit exactly . . . be perfectly flat and rigid . . . with 32 holes molded into the stator for contact points. The assembly was too delicate—tolerances too exacting—for manufacture from fired ceramics.

This difficult electronic problem was solved with General Electric mycalex—a stone-like insulating material composed of special glass and powdered mica. G-E mycalex offers a unique combination of properties, including heat resistance up to 700 F, high dielectric strength, excellent chemical and dimensional stability. Proving the best possible material for *this* application, it may well prove the answer to some tough electronic problem of *yours*.

**G.E.'s COMPLETE MOLDING SERVICE
OFFERS YOU 60 YEARS' EXPERIENCE**



Very Important Protection for tubing and small parts can be obtained with G-E sealing caps and sleeves. They're an inexpensive way to seal out air, moisture, dirt and chemicals; insulate wires; protect valves from mishandling.

G-E silicone rubber parts are ideal for electrical applications. They offer low moisture absorption, excellent heat resistance, and good dielectric strength.



For more information, write to General Electric Company, Section L-3, Chemical Division, Pittsfield, Mass.

GENERAL  ELECTRIC

temperature stability over older materials, as well as drawings of the many standard shapes available. The cores described can be directly substituted for nickel-containing ferrite cores in most horizontal tv deflection yokes and horizontal output transformers without need for redesign.

Potentiometer Circuits. Minneapolis-Honeywell Regulator Co., Brown Instrument Div., Wayne and Windrim Ave., Philadelphia 44, Pa. Bulletin B15-13 discusses the characteristics of the measuring circuits used in the Elektronik potentiometer. It is the second of a series for the benefit of those who wish to apply and utilize this versatile instrument to unique or specialized measurements frequently encountered in scientific and technical investigations.

Products Catalog. General Cement Mfg. Co., 919 Taylor Ave., Rockford, Ill. Catalog No. 155 is a 64-page illustrated description of a wide line of products for the radio and electronic industries. It is divided into four parts: (1) radio chemicals; (2) radio and tv parts and service aids; (3) alignment tools and radio tools; and (4) radio hardware. Prices of all items are included.

Midget Relays. Signal Engineering & Mfg. Co., 154 W. 14th St., New York 11, N. Y. Bulletin MTR-64 is a 4-page brochure describing and illustrating the series 80 line of midget telephone type relays. It contains information and drawings regarding types of covers, characteristics, general specifications and pertinent data.

Sensitive Photometer. Ultrasonic Engineering Co., P. O. Box 46, Maywood, Ill., has published a four-page bulletin completely describing its electron-multiplier photometer that is ultrasensitive and line operated, using a stabilized direct-connected amplifier with two independent power supplies. With the instrument described changes in light strength of the order of 5/1,000,000 microlumens are easily measured. Characteristics chart and price list are included.

**Built Right!
Priced Right!**

**BECCO UNIVERSAL
IMPEDANCE BRIDGE**



Exclusive **DEKADIAL**
for high precision readings

Shown: Model 250-C

Write today for complete information and current low price
BROWN ELECTRO-MEASUREMENT CORP.

Instrument **BECCO** Specialists

4635-37 S. E. HAWTHORNE BLVD. PORTLAND 15, OREGON

Completely Accessible

from operating surface dependable instruments



Type A-708...24-channel



FEATURES

- Completely accessible from operating surface
- Compact...can be mounted in a minimum of space...lightweight
- Can be panel mounted
- 6 to 24 channels
- Paper widths 5", 8", 12", 18"
- Simplicity of loading
- Direct monitoring of galvanometer light spots
- Flexibility of operation
- Simultaneous viewing, recording and scanning
- Trace identification...zero mirror...synchronizing reference trace
- Adjustable automatic record length

AUTOMATIC OSCILLOGRAPH RECORDER

Affording complete accessibility from operating surface and requiring only a minimum of space for mounting, the HEILAND A-708 meets the exacting specifications of research and development personnel in aircraft flight testing, laboratory and industrial testing.

Write for complete details

HEILAND RESEARCH CORPORATION • 130 East Fifth Ave. • Denver, Colo.

THIS IS IT!

World-wide recognition for this outstanding line of electric soldering irons —

HEXACON

— specified by the big names for the **TOUGH JOBS!**

WESTERN ELECTRIC, BENDIX, MINNEAPOLIS HONEYWELL RADIO CORP. OF AMERICA, STROMBERG CARLSON, SPERRY, WESTINGHOUSE, EMERSON, KAISER, etc.

PLUG OR SCREW TIPS 40 to 700 Watts
1/8" to 1/4" Tip Dia.

Follow the leaders and you'll specify HEXACON! They'll efficiently solve your soldering problems. Write for literature.

Here's the famous **HATCHET TYPE**

These irons feature better balance for reduced operator fatigue. Efficiency is stepped up, and quality of work is improved. The ideal iron for inaccessible and intricate jobs.

HEXACON ELECTRIC CO.

130 W. CLAY AVE., ROSELLE PARK, N. J.

Cut Your Costs, Too, With

**POWRARM
WORK POSITIONERS**

HERE'S HOW OTHERS DO IT



POWRARM cuts costs by increasing every worker's productivity. It gives the worker a powerful *third hand* to hold work while two hands produce. That's why POWRARM works on the most efficient assembly lines in America today, and *belongs on yours*. Write us about your production "headache" . . . we'll show you how POWRARM can cure it.

Write For Catalog 101E
32 informative pages, FREE



Holds work at any angle in Horizontal, Vertical or Co-axial Plane.

Three sizes of Powrarm—24 to 150 lbs. capacity.



WILTON TOOL MFG. CO.

Precision Built Bench Vises, "C" Clamps and Work Positioners

925-T Wrightwood Avenue • Chicago 14, Illinois

News From The Field

Edited by WILLIAM P. O'BRIEN

RACES Proposal by FCC

THE PROPOSED Radio Amateur Civil Emergency Service would set up machinery for a temporary radio-communication service to be carried on by licensed amateur radio stations while operating on specifically designated segments of the regularly allocated amateur frequency bands under the direction of authorized local, regional or federal civil defense officials according to an approved civil defense communications plan. The Commission will receive comments upon its proposal until Feb. 15, 1952.

In effect, the Federal Communications Commission offers a formula for tapping at least a portion of the nearly 100,000 licensed amateurs and their existing equipment for civil defense use. Although the plan is predicated upon the individual operator, already licensed, it provides safeguards to insure that his authorization and activity are properly sponsored and directed.

He is prohibited from engaging in defense communications except with permission and under the control of an established network.

Municipalities desiring to make use of their amateurs must file a comprehensive civil defense communications plan that has been approved down the line. It must appoint a qualified Civil Defense Radio Officer responsible for the utilization of the plan. All such officers and operators must be shown reliable and loyal.

Among the technical requirements, most of which follow standard amateur procedure, are the frequency bands and authorized emissions listed below. Selection and use of specific frequencies within the bands depends upon coordination of local and area plans. In the range from 1,800 to 2,000 kc, the availability of frequencies depends upon the loran system use as already set forth in FCC rules.

Table I—RACES Bands and Emissions

FREQUENCY BAND	Authorized Emissions							
	0.1 A1	1.1 F1	2 A2	3 F2	6 A3	6 A4	6 F3	40 F3
1,800-1,825 Kc.....	●				●			
1,875-1,900 Kc.....	●				●			
1,900-1,925 Kc.....	●				●			
1,975-2,000 Kc.....	●				●			
3,500-3,510 Kc.....	●	●						
3,990-4,000 Kc.....	●	●			●	●		
28.55- 28.75 Mc...	●				●	●	●	
29.45- 29.65 Mc...	●	●			●	●		●
50.35- 50.75 Mc...	●		●		●	●	●	
53.35- 53.75 Mc...	●	●	●	●	●	●		●
145.17-145.71 Mc...	●	●	●	●	●	●		●
146.79-147.33 Mc...	●	●	●	●	●	●		●
220-225 Mc.....	●	●	●	●	●	●		●

Emission data is given in the form of a bandwidth figure in kilocycles followed by the modulation method, amplitude being represented by A and frequency modulation by F. The practical designations possible are also listed below.

- 0.1 A1—Continuous-wave telegraphy;
- 1.1 F1—Frequency-shift telegraphy;
- 2 A2—Telegraphy, amplitude-modulated at audio frequency;
- 3 F2—Telegraphy, frequency-modulated at audio frequency;
- 6 A3—Commercial-quality amplitude-modulated telephony;
- 6 F3—Narrow-band frequency or phase-modulated telephony;
- 40 F3—Wide-band frequency or phase-modulated telephony;
- 6 A4—Amplitude-modulated facsimile.

Components Conference Scheduled

AIMED at promoting still further improvement in the quality of electronics components, particularly for military equipment, a second government-industry conference will be held in Washington, D. C., from May 5 to 7, 1952. This announcement was made recently by J. G. Reids, Jr., of the National Bureau of Standards, chairman of the Conference Steering Committee.

Like the last conference held in May 1950, the forthcoming session is sponsored jointly by the RTMA, the IRE and the AIEE, in cooperation with the Research and Development Board and other Department of Defense agencies and the National Bureau of Standards.

Army Mobile Radio Station

A FIVE-UNIT radio station on wheels has been developed by the Signal Corps and is now being put into use in Korea. Its range is several hundred miles.

The units, designed for use by Psychological Warfare teams, are housed in a pair of 26-foot trailers and three 11-foot shelters. They can be transported by truck and trailer on land, by cargo planes aloft and by ships at sea. During amphibious assaults, the units can be floated ashore after simple sealing preparations.

Equipment for this mobile station includes sound-proofed, air-conditioned studio and control

Leaders in their field



INDUSTRIAL
AMPLIFIERS



MOBILE
AMPLIFIERS



THREE SPEED
PHONOGRAPHS



TURNTABLE
UNITS



OFFICE
COMMUNICATORS



SHADED POLE
MOTORS



PORTABLE
AMPLIFIERS

Leading manufacturers of Sound Reproducing Equipment, Inter-Office-Communicators, Single and Multiple Speed Gramophone Units, Shaded Pole Motors and Beat Frequency Oscillators. Advanced design, a modern well equipped factory and rigorous stage by stage inspection all contribute to the high standards which classify B.S.R. "Leaders In Their Field."

Further details available on application.

BSR

U.S. Warehouse and Offices.

SAMCO PRODUCTS COMPANY

36, Oak Avenue, Tuckahoe, N.Y.

Telephone: Tuckahoe 3-9391

Made by Birmingham Sound Reproducers Ltd., Old Hill, Staffs. England. Grams: 'Electronic Old Hill, Cradley Heath.'



Cpl. Charles Cooper, radio engineer of Parkersburg, W. Va., cues two soldiers to begin propaganda message on new Signal Corps mobile radio broadcasting station. All are members of Army Psychological Warfare units. The new station can handle over a half-million words of copy daily, has own studio, control room and power supply

rooms, magnetic tape-recorder-producer units, turntables and remote pickup units for on-the-spot broadcasts away from the roving station.

Signal Corps completed the first station in a record time of four months, with construction already started on four additional units to be used at other overseas outposts.

Changes Among Engineers

A SERIES of personnel changes affecting many companies in the electronics field has recently taken place. Among them are the following:

Joseph H. Lancor, Jr., has been appointed director of the transducer division of *Consolidated Engineering Corp.*, Pasadena, Calif. He will be responsible for directing design and development of various types of transducers, including vibration pickup, accelerometers and pressure pickup. In his former position as director of product engineering of *Vitro Corp. of America*, he supervised classified Navy projects, including guided missiles and electronic weapons.

Robert L. Rod has been promoted from project engineer to assistant director of research at *Bogue Electric Mfg. Co.* The president of the company stated that Mr. Rod will assist David H. Ransom, director

of research, in directing research and development in the fields of magnetic amplifiers, microwave communications systems and industrial control equipment.

The appointment of Paul Hines as director of engineering for *Workshop Associates*, Division of Gabriel Co., has also been announced. Formerly with *Raytheon Mfg. Co.*, he will be in direct charge of the new Workshop laboratory soon to be opened in Natick, Mass.

William E. Osborne, formerly director of electronics at *Hycan Mfg. Co.* of Pasadena, Calif., has been elected president and general manager of *Resdel Engineering Co.* of Los Angeles.

Also noted recently is the appointment of Brig. Gen. Tom C. Rives (Ret.) to the post of manager of the newly established *General Electric Advanced Electronics*

Center at Cornell U., Ithaca, N. Y. Saul Decker has been promoted from assistant chief tv engineer to chief tv engineer of *CBS-Columbia, Inc.*, manufacturing subsidiary of the Columbia Broadcasting System. Robert L. Wolff, formerly chief radio-electrical engineer, has been promoted to director of *Centralab Products* engineering.

SMPTE Elections

FRANK E. CAHILL, JR., of the Warner Bros. Circuit Management Corp., N. Y., was recently elected financial vice-president of the Society of Motion Picture and Television Engineers.

Other newly elected officers of SMPTE are: treasurer, Barton Kreuzer of RCA Engineering Products Dept., Camden, N. J.; and engineering vice-president, Fred T. Bowditch of National Carbon Div. of Union Carbide and Carbon Co., Cleveland. Mr. Bowditch was re-elected to this post.

Newly elected governors of the society include Axel G. Jensen of Bell Telephone Laboratories, Murray Hill, N. J.; Joseph E. Aiken of Naval Photographic Center, Anacostia, D. C.; George W. Colburn of G. W. Colburn Laboratories, Chicago; Ellis W. D'Arcy of DeVry Corp., Chicago; John K. Hilliard of Altec-Lansing Corp., Beverly Hills; and Fred G. Albin of American Broadcasting Co., Hollywood.

Newly elected officers and governors took office January 1 and will serve two-year terms.

Radiolocation Service

BECAUSE of increasing demands for oil and the problems of prospecting underwater as far as 150 miles into the Gulf of Mexico, the FCC has established a Radiolocation Service allocation.

Standard loran and microwave systems have so far proved impracticable for the distances and accuracies required. Current workable systems employ phase-comparison methods at low or medium frequencies (ELECTRONICS, p 70, April 1949). But since present operations are on a temporary basis, there has

ORIENTED ELECTRICAL STEELS for a wide range of uses

These are typical flux-current loops for Armco Oriented Electrical Steels. They demonstrate the wide range of thicknesses that Armco offers in these iron-silicon alloys, and illustrate the excitation and loss characteristics when operating at frequencies within the range of highly efficient performance.

The broad selection of thicknesses extends the advantages of preferred orientation to many new applications, serving commercial- to high-frequency requirements.

Complete information on the 14-mil thick Armco TRAN-COR 2X-O and 3X-O is given in the booklet, "Armco Oriented Electrical Steels." The booklet "Armco Thin Electrical Steels" gives data on Armco TRAN-COR T-O in 1-, 2- and 4-mil thicknesses and Armco TRAN-COR T-O-S, a super-oriented electrical steel in 4-mil thickness only.

Data on $\frac{1}{4}$ -, $\frac{1}{2}$ - and $\frac{3}{4}$ -mil Armco TRAN-COR T-O are being prepared. There are Armco Electrical Steels in 5- and 7-mil thicknesses for multi-directional applications as well as a complete line of Hot-Rolled and Radio grades. Write us for the information and booklets you want.

ARMCO STEEL CORPORATION

1162 Curtis Street, Middletown, Ohio • Plants and sales offices from coast to coast • Export: The Armco International Corporation



FLUX-CURRENT LOOPS

(Both eddy current & hysteresis losses)

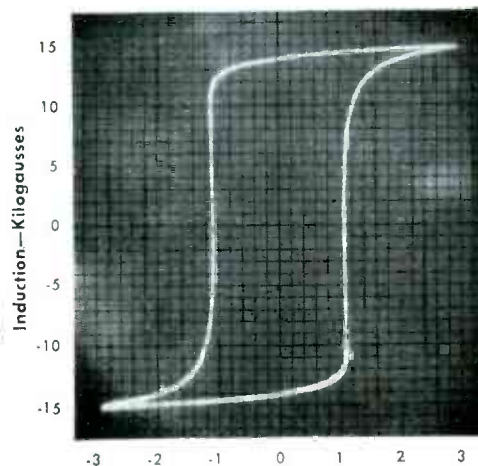

Excitation—Amp-Turns per Cm

Armco TRAN-COR T-O

$\frac{1}{2}$ mil thick
10,000 cps

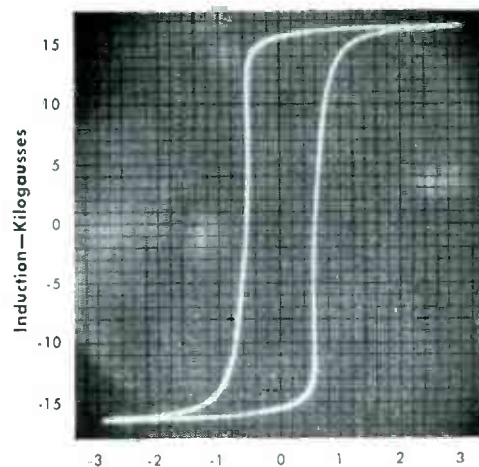

Excitation—Amp-Turns per Cm

Armco TRAN-COR T-O

4 mils thick
400 cps

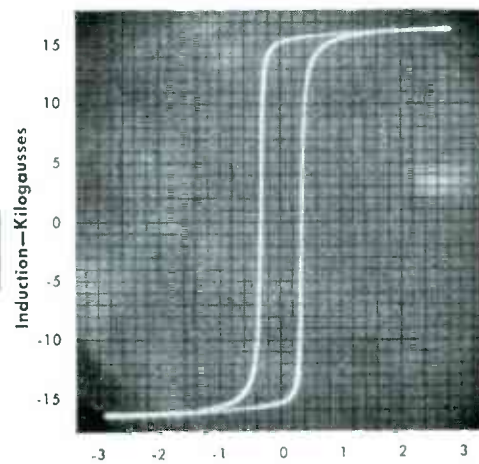

Excitation—Amp-Turns per Cm

Armco TRAN-COR 3X-O

14 mils thick
60 cps

You Get...

**REDUCED
WIRING COSTS**

**FASTER, LOWER
COST ASSEMBLIES**

**IMPROVED
RELIABILITY**

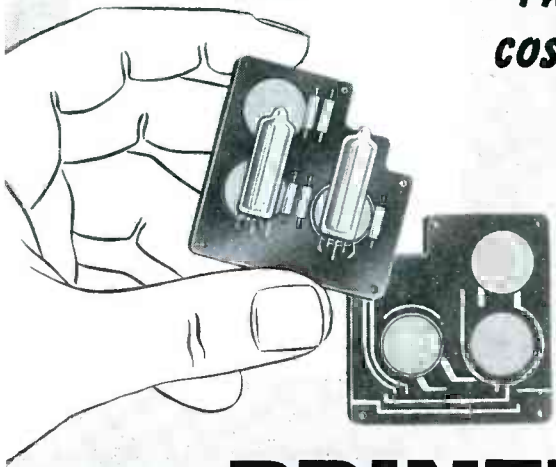

with **PRINTED
CIRCUITS**
and Allied Electronic Assemblies

"Photocircuits Printed Circuits" of copper, aluminum, silver and brass on a variety of rigid and flexible plastic laminates are used in electronic equipment.

The etched and punched circuit will be supplied ready for assembly or completely assembled as desired.

We offer fast, low cost service on sample and pilot run quantities and have ample facilities for volume production.

The Photocircuits Corporation solicits your printed circuit and allied electronic assembly business. We are confident that our quotations will be satisfactory and cost reducing.

WHAT'S NEW!

...Flush Commutators and Wiping Contact Switches.

Plated metal foil patterns are embedded in the base material. A life upwards of 10-million revolutions can be expected of the contact surfaces.

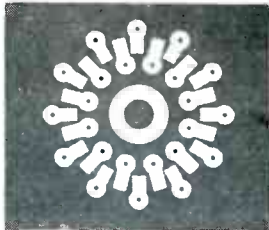

Let our engineering facilities and experience help solve your design and application problems. Literature and data available on request.



PHOTOCIRCUITS Corporation
Dept. E, GLEN COVE, NEW YORK

See us at the I.R.E. Booth 463

been little incentive for development of systems using these frequencies.

Radiolocation has been assigned the band between 1,750 and 1,800 kc on a shared basis with the Disaster Service. This arrangement is possible because tests and drills, aside from operations in actual emergency, are primarily carried on at night. The petroleum industry's radiolocation activities occur chiefly during the day. However, a portion of the machinery set up for administering radiolocation will involve methods of immediately shutting down this service if it interferes with the Disaster Service.

Although the new service is a "permanent allocation", it has been placed upon a "developmental basis" until at least July 1954, before which time it will be completely reviewed.

**Signal Corps Seeks
Electronics Workers**

There is an urgent need for electronics equipment installer-repairmen for duty in the Army Communication Center at the Pentagon, Washington, D. C., the Signal Corps has announced. The Civil Service positions, paying from \$1.47 to \$2.27 per hour, require rotating-shift duty.

No written test is required. Applicants are rated on a basis of their training and experience, as described in their applications. A certain amount of credit is allowed for advanced amateur radio operation.

Persons interested in these positions should file Application Form 57, Supplemental Experience Form CSC-206, and Card Form 5001 ABC with the Executive Secretary, Board of U. S. Civil Service Examiners, Military District of Washington, Room 2E-1030, Concourse, The Pentagon, Washington 25, D. C.

Complete information regarding duties and minimum qualification requirements, together with application forms, may be obtained from the Executive Secretary, Board of Civil Service Examiners, MDW, Room 2E-1030, Concourse, The Pentagon, Washington 25, D. C.; from the Fourth U. S. Civil Service Re-

TRIED and PROVEN THE WORLD OVER



LETTINE MODEL 240 TRANSMITTER WITH MOBILE CONNECTIONS AND A.C. POWER SUPPLY

This outstanding transmitter has been acclaimed a great performer throughout the world. It is excellent for fixed station, portable or mobile operation.

The 240 is a 40 watt transmitter for CW and plate modulated Phone operation, operating on any frequency from 1.8 to 30 mc.; complete with self contained 115 volt A.C. power supply, mobile connections, meter, (8 x 14 x 8) cabinet and tubes: 6V6 osc., 807 final, 6SJ7 crystal mike amp., 6N7 phase inverter, 2 6L6's mod., 5U4G rect. Weight 30 lbs. 90 day guarantee. Also used on 160 to 10 meter Amateur bands.

PRICE: less coils and crystal.....\$76.55
Coils for any one freq. from 1.8 to 3.5 mc. \$3.60
Coils for any one freq. from 3.5 to 30 mc. \$2.91

Send order to:

LETTINE RADIO MFG. CO.

62 Berkley St. Valley Stream, N. Y.

PRODUCTIMETER "SPECIALS" for Radar and Electronic Applications

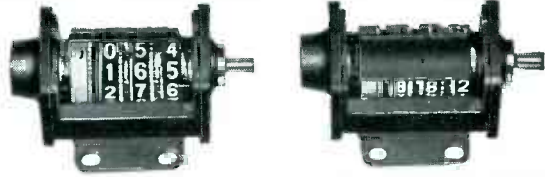

Companion shutter counters used as dual direction indicators. One counter adds while the other subtracts. Shutter blanks out counter which is on negative side of 000.



"Y" 2-figure Rotary Counter used in navigating instruments.

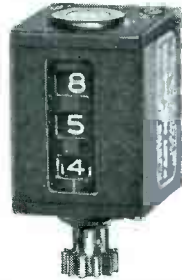

High-speed, non-reset "Y" type counter for building into radar instruments.



Special Model "Y" with window at rear designed for use in radar equipment.

These are a few of the "specials" developed by Durant for Radar and Electronic applications. When one of the many standard Productimeters is not the exact answer to a problem, Durant engineers modify, combine, or develop entirely new counters to meet the particular requirements of the job.



DURANT MFG. COMPANY
1912 N. Buffum St. 112 Orange St.
Milwaukee 1, Wis. Providence 3, R.I.
Representatives in Principal Cities

PRODUCTIMETERS

SINCE 1879

Speedometers OF INDUSTRY

SPECIALISTS IN ELECTRONIC GEARS



**QUAKER CITY
GEAR WORKS**

1910 N. FRONT ST.
PHILADELPHIA 22, PA.

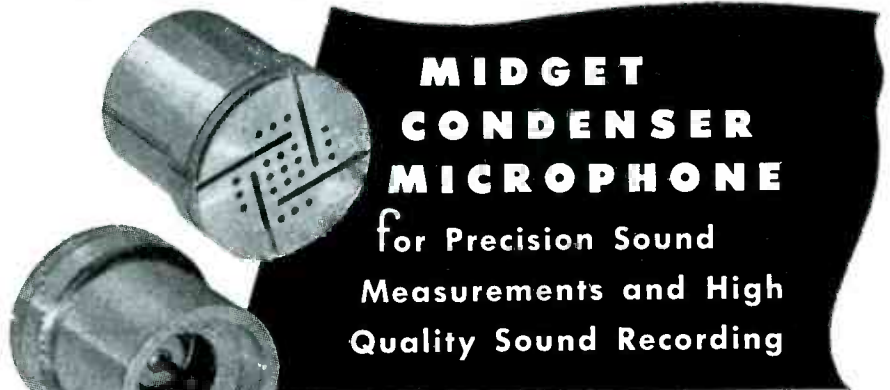

Built to give years of service without change in calibration. Even without dessicators, Kellogg Midget Condenser Microphones show no detectable drift in laboratory service. Proven in use for optimum performance for more than 15 years.

PRINCIPAL CHARACTERISTICS

	MODEL A	MODEL B
RESPONSE (Referred to 1 volt/dyne/cm ²)	-59 db	-55 db
FLAT TO WITHIN	± 3 db from 20 to 11,000 cps, for closed cavity without grille.	± 4 db from 20 to 15,000 cps with or without grille for perpendicular incidence in free field.

Users Include government laboratories, universities, audio development laboratories, sound studios and industrial plants manufacturing sound equipment.

● SEND FOR FULL SPECIFICATIONS TODAY! WRITE DEPT. 26 B

KELLOGG SWITCHBOARD AND SUPPLY COMPANY

Established 1897

MIDGET CONDENSER MICROPHONE

6650 South Cicero Avenue, Chicago 38, Illinois

TAYLOR TUBES

... "First Choice" for
Technical Excellence!

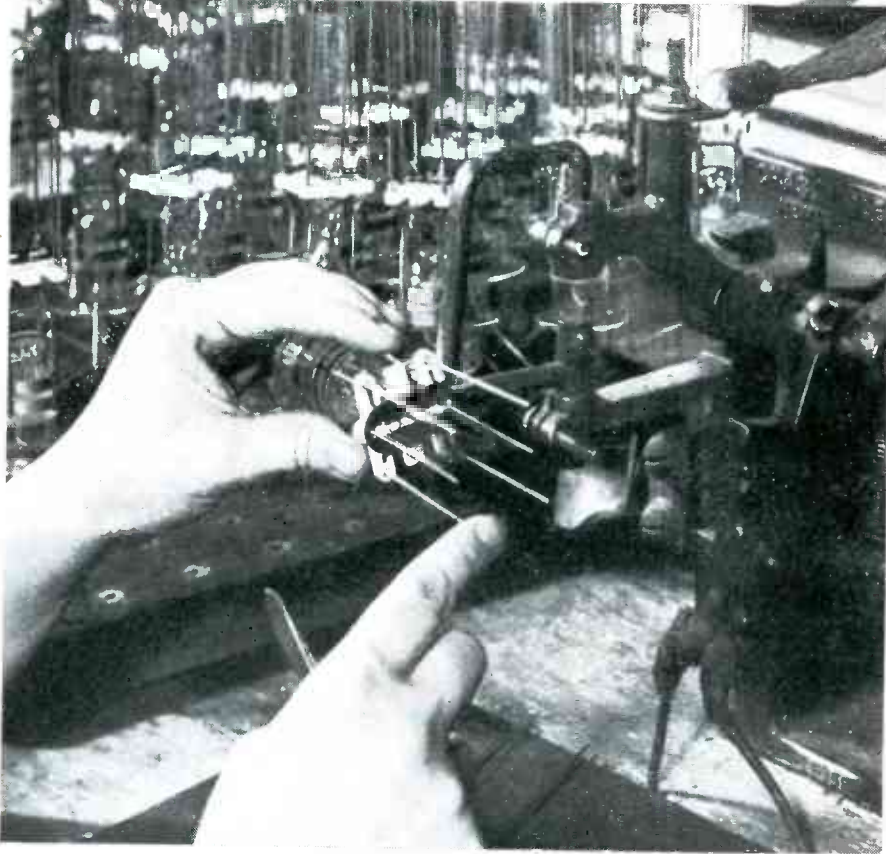

There was an unmistakable pride of craftsmanship that characterized the first Taylor Tube built many years ago. Since then, hundreds of thousands of tubes bearing the Taylor mark have enjoyed a special admiration for their uniform ability to do every job better than expected. Today, "TQS", the *Taylor Quality Standard* is known and respected the world over. Taylor Tubes can do better for you.

★ TRANSMITTING

★ INDUSTRIAL

★ RECTIFIER

★ ELECTRONIC

As always, Taylor is producing tubes of superior quality and outstanding performance. The Taylor Representative nearest you is ready and willing to discuss your particular requirements. Call on him for information any time.

Taylor HEAVY **CUSTOM BUILT** DUTY **Tubes**

TAYLOR TUBES INC., 2312-18 WABANSIA AVE., CHICAGO 47, ILL.

Export: Royal National Company
75 West St., New York 6, N.Y.

Cable Address:
NATVARNCO, NEW YORK

gion, 4th and Jefferson Drive, Southwest, Washington 25, D.C.; or from the U.S. Civil Service Commission, Washington 25, D.C.

Plant Expansions Announced

SEVEN plant expansions were reported on the west coast:

Hoffman Radio Corp., Los Angeles, has acquired the one-story building adjacent to its No. 5 plant at 6200 So. Avalon Blvd., for tv set manufacturing. Known as plant 5A, it contains 38,000 sq ft of floor area, making the total of the seven Hoffman plants approximately 700,000 sq ft.

Purchase of a new factory building at 1521 E. Grand Ave., El Segundo, Calif., has been announced by *International Rectifier Corp.* Its



New International Rectifier plant

present plant in Los Angeles will be maintained for research and development.

Technical Associates, Inc., Burbank, Calif., has just moved into its new building providing more than three times the space of the original location. The enlarged facilities were made necessary by the expansion of the company's efforts in government defense production of nuclear research instruments.

Philco Corp. has established in Los Angeles a factory branch known as Philco Los Angeles, a division of Philco Distributors, Inc.

Varian Associates, presently located in San Carlos, Calif., has leased a 10-acre site in Palo Alto on which it will build a 30,000-sq ft structure. The company has contracts with all branches of the military and will specialize in klystron oscillators and modulators used in radar and other electronic devices.

Dalmotor Co., Santa Clara, Calif., manufacturer of motors used in

TEST YOUR MAGNETIC CIRCUITS



**RAWSON FLUXMETER
TYPE 504**

The only portable fluxmeter available which returns rapidly to zero when a single button is depressed. Simple and fast in operation. Convenient and light in weight.

Nor limited to a single type of measurement. Has universal application for laboratories or production. Measures strength of magnets and electromagnets, permeability and hysteresis loops for iron and steel, total flux lines in circuit, flux lines developed in air gap, etc.

Has a mechanical clamp to protect the pivots and jewels when in transit.

Also in production, the NEW
ROTATING-COIL GAUSSMETER

RAWSON ELECTRICAL INSTRUMENT COMPANY

111 POTTER STREET, CAMBRIDGE 42, MASS.
Representatives

CHICAGO

LOS ANGELES

Special TRANSFORMERS Individually Built To YOUR Specifications

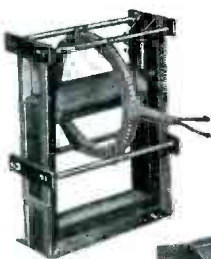

Estab.
1920

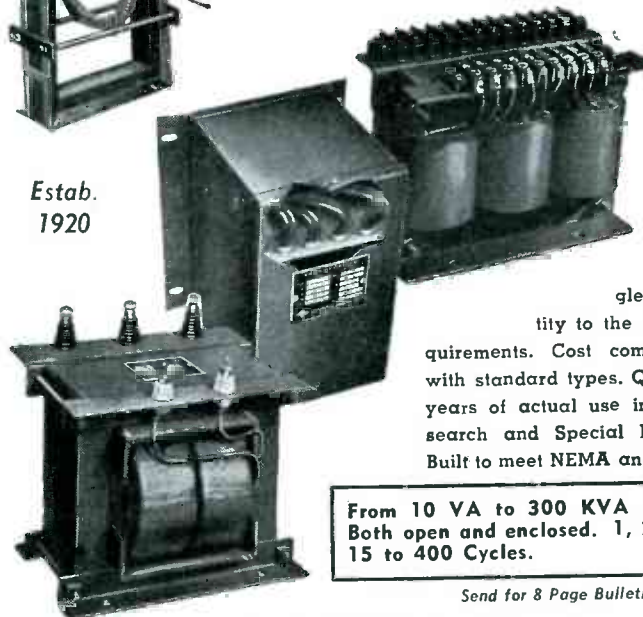

IN
SMALL
QUANTITIES

For 31 years
we have been
building trans-
formers in sin-
gle units or in quan-
tity to the most exacting re-
quirements. Cost compares favorably
with standard types. Quality proved by
years of actual use in Electronics, Re-
search and Special Instrument fields.
Built to meet NEMA and ASA Standards.

From 10 VA to 300 KVA Dry-Type only.
Both open and enclosed. 1, 2 and 3 Phase.
15 to 400 Cycles.

Send for 8 Page Bulletin, and Price List



NOTHELPER

WINDING LABORATORIES

9 ALBEMARLE AVE., TRENTON 3, N. J.



QUALITY RIBBONS and STRIPS

for the ELECTRONIC
INDUSTRIES

- MOLYBDENUM
- TUNGSTEN
- TANTALUM
- FORMED
PIECES

Your Special Metals Rolled to
Thin Sizes and Close Tolerances
YOUR INQUIRIES WILL
RECEIVE PROMPT
ATTENTION

H. CROSS CO.

15 BEEKMAN ST., N. Y. 38, N. Y.
Worth 2-2044 and Cortlandt 7-0470

ATTENUATORS by TECH LABS

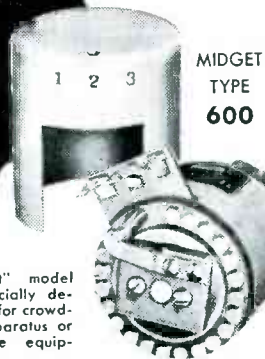

"Midget" model
is especially de-
signed for crowd-
ed apparatus or
portable equip-
ment.

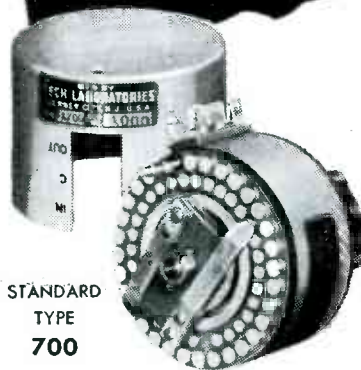

STANDARD
TYPE
700

- Solid silver contacts and stainless silver alloy wiper arms.
- Rotor hub pinned to shaft prevents unauthorized tampering and keeps wiper arms in perfect adjustment.
- Can be furnished in any practical impedance and db. loss per step upon request.
- TECH LABS can furnish a unit for every purpose.
- Write for bulletin No. 431.



Manufacturers of Precision Electrical Resistance Instruments

PALISADES PARK • NEW JERSEY

MICROPOT

PRECISION TEN-TURN POTENTIOMETER

1. You get permanent accuracy because the resistance wire is locked in place. It is precision positioned and moulded integrally with the housing.
2. You get permanently accurate settings, smooth action and low uniform torque provided by the stainless steel, precision ground, double thread lead screw guiding the moving contact.
3. You get precise positioning of the moving contact because of the two bearings supporting the rotor assembly.
4. You get good rigid terminals because they are moulded integrally with the housing.
5. Terminals soldered to ends of resistance element before moulding. Entire resistance circuit is an integral part of the housing.
6. You get accurate setting and resetting due to anti-backlash spring in contact guide.
7. You get a fine resolution because of the $43\frac{1}{2}$ " length of resistance wire in the spiral element.
8. You get a resistance output directly proportional to shaft rotation within $\pm 0.1\%$ of the total resistance. Every potentiometer is automatically machine tested for linearity at 101 points.

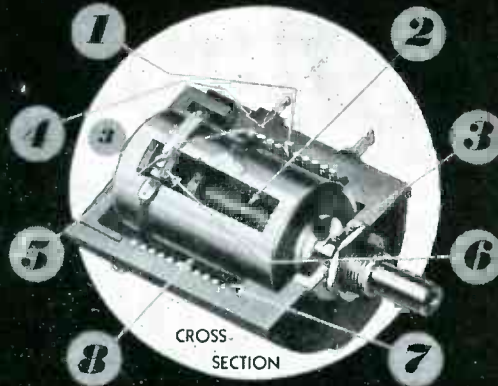

**LINEARITY
ACCURACY $\pm 0.1\%$**

Units for immediate shipment:
1,000 to 30,000 ohm range.
Special resistance values made to order.

WRITE TODAY FOR
ENGINEERING INFORMATION



BORG EQUIPMENT DIVISION

THE GEORGE W. BORG CORPORATION

JANESVILLE • WISCONSIN

ELECTRAN

TRANSFORMERS

- ★ TRANSFORMERS
- ★ SATURABLE REACTORS
- ★ ELECTRONIC DEVICES

Specialists in **SMALL** quantities
of custom built transformers
from milliwatts
to 50 KVA, single
or polyphase—
designed and
manufactured to
best meet your
exact requirements.

Each
Electran Transformer
is built to the
highest standards
of
quality and precision.
There is no
"second" grade
at Electran.

ELECTRAN MFG. CO.

1901 CLYBOURN AVENUE • CHICAGO 14, ILLINOIS

radar equipment by the armed services, is doubling the size of its present plant to 10,000 sq ft.

The center core of an aircraft components plant which has the capacity to expand physically by 500 percent if necessary has been completed by *The Garrett Corp.*, Los Angeles, for its newest division, *AiResearch Mfg. Co.* of Arizona at Phoenix.

Reports from the midwest indicate three major plant expansions:

Bodine Electric Co. has opened a new addition to its No. 2 Chicago plant, located at 2650 Addison St. The new building has a floor space of 14,000 sq ft.

Now nearing completion is an addition to the Lac du Flambeau Wisconsin branch of the *Simpson Electric Co.* The new wing, adjoining the main factory building, will provide more assembly lines for test equipment and panel meters and will also give full employment to the remainder of the Chippewa Indians who live on the nearby reservation and are now 75 percent employed by Simpson.

Sprague Electric Co. announces the opening of an application engineering office at 3 East Second St., Dayton, Ohio. This is intended to provide more effective contact with midwestern Government research and development laboratories.

In the east also, a number of plant expansions are reported:

Raytheon Mfg. Co. has leased a one-story brick building on Seyon St., Waltham, Mass., providing 50,000 sq ft of space and increasing the company's employment rolls by approximately 400 workers.

Technitrol Engineering Co., manufacturers of manometers, ballistocardiographs, electronic computing machines and such components as acoustic memory units, have moved into a new plant with more than three times the floor space formerly occupied. The new address is 2751 N. Fourth St., Philadelphia, Pa.

Tel-O-Tube Corp. of America, c-r tube manufacturer, has purchased the entire equipment and inventory of the *Video Industry Products Co.* of Paterson, N. J. The move will enable Tel-O-Tube to expand its facilities into large-scale production

• **Electronics**
MANUFACTURERS . . .
. . . LABORATORIES
UNIVERSITIES . . .
. . . BROADCASTERS

We don't sell surplus, but we can offer equal values with new merchandise. Send for list of our lines. Let us place your name on our mailing list and place our name on your mailing list to receive your requests for bids.

Address: Industrial Dept.

DeMAMBRO
Radio Supply Co., Inc.

"New England's Largest
 Electronics Distributor"

1111 COMMONWEALTH AVE.
 BOSTON 15, MASS.
 Telephone STadium 2-1342

BRANCH OFFICES

Providence, R. I., 90 Broadway
 Worcester, Mass., 222 Summer St.
 Manchester, N. H., 1308 Elm St.

when you need a

**QUALITY
 OSCILLATOR**



**MODEL M-2
 IS YOUR ANSWER**

The unique SIE oscillator circuit which has no lower limit to its possible frequency of oscillation is responsible for the excellent low frequency performance of the Model M-2 and other SIE oscillators. Write today for complete specifications.

**SOUTHWESTERN
 INDUSTRIAL
 ELECTRONICS CO.**

2831 Post Oak Rd. Houston 19, Texas
 434 Seventh Ave. East—Calgary,
 Alberta, Canada

MICRODIAL

TEN TURN-COUNTING DIAL

Microdial is composed of two concentrically mounted dials . . . one for counting increments of each turn and the other for counting turns. The incremental dial has 100 equal divisions and is attached rigidly to the shaft so there is no backlash. Thus the contact position is indicated to an indexed accuracy of 1 part in 1000. Rotation is continuous in either direction. There are no stops on the Microdial assembly.

COMPACT . . . Microdial has same O.D. as Micropot . . . requires no more panel space.

CLEAR READING . . . Forced fast-reading tests showed only 1/20th as many errors with Microdial open window as with next most legible dial. Turn counter distinguishes between 0 and 10 turn readings, and accelerates to avoid confusion on readings near integral turns. Precise readings are made from larger dial with maximum separation of graduations and wide angle visibility.

CONVENIENT . . . delivered completely assembled with dials synchronized. Easily mounted in a few seconds. All dials may be locked.

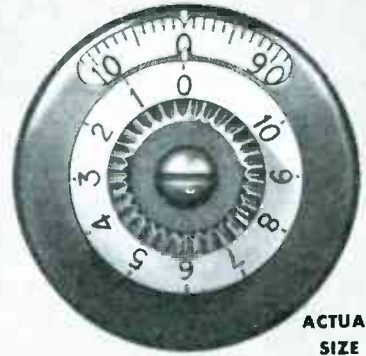

ACTUAL SIZE

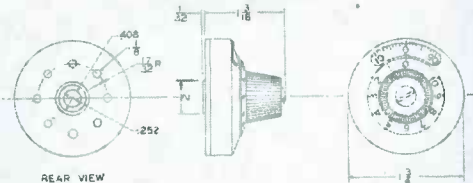

Microdial . . . turn-counting dial, primarily designed for use on Micropot ten turn linear potentiometers . . . use it on any multiturn device having ten turns or less.



BORG EQUIPMENT DIVISION

THE GEORGE W. BORG CORPORATION

JANESVILLE • WISCONSIN

**SHIELDING
 PROBLEMS**

effectively and economically solved with

METEX

electronic "Weather Strips"

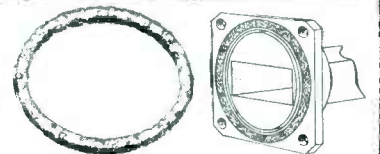
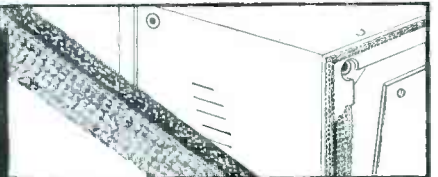

Resilient . . . Conductive . . . Compressible . . . Cohesive

From closures for cabinets to gaskets for waveguide couplings, Metex Electronic Shielding assures lasting metal-to-metal contact to prevent leakage, without the need for costly machining to secure precise surface-to-surface contacts. Metal wire — knitted, not woven or braided — gives Metex Electronic Strips and Gaskets that combination of conduc-

tivity and resiliency which makes them so effective and economical for shielding.

For a more detailed picture of the scope of utility of Metex Electronic Products, write for free copy of "Metex Electronic Weather Strips." Or outline your specific shielding problem—it will receive immediate attention.

METAL TEXTILE CORPORATION

KNITTERS OF WIRE MESH FOR MORE THAN A QUARTER CENTURY



641 East First Avenue

Roselle, N. J.

COAXWITCH

COAXIAL SELECTOR SWITCH

50 Ohms —
Type N Connectors—Manually Controlled
Low VSWR—4 Models

CUT-A-WAY VIEW, MODEL 74

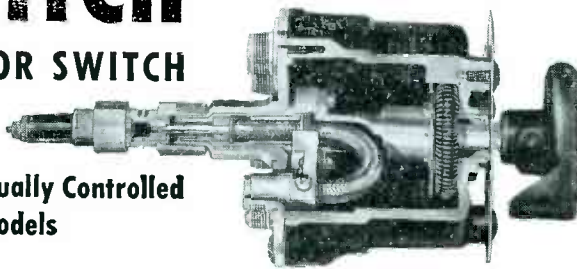

The COAXWITCH is an RF switch for use in coaxial circuits where it is important that the 50 OHM impedance of the cables be maintained. In a circuit sense, this switch consists of two pairs of "N" connectors spaced 4½" apart using RG-8/U as the connecting link. The COAXWITCH itself introduces no VSWR other than that of connectors. Characteristic impedance is maintained thru all switch details. Cut-a-

way view shows that shield as well as center conductor is switched. Beryllium copper contacts, on the gooseneck, mate directly with male "N" (Type UG-21B/U) connectors, which connect directly to back plate of switch. Since all connectors come out in line with axis of switch, right angle connectors are usually unnecessary.

Literature Gladly Sent

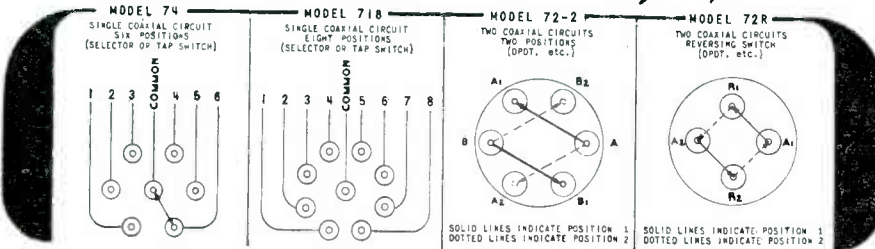

BIRD
ELECTRONIC CORP.
TERMALINE COAXIAL LINE INSTRUMENTS

1800 EAST 38TH ST.
CLEVELAND 14,
OHIO
West Coast:
NEELY ENTERPRISES
HOLLYWOOD 46, CAL.

New ENGINEERING DATA on STAR PORCELAIN SPECIALTIES



SEND FOR YOUR COPY

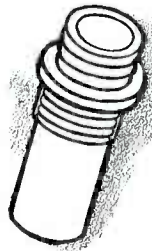
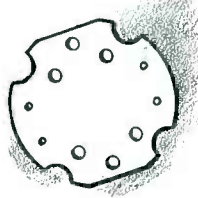

Helpful information on electrical, thermal and mechanical characteristics of ceramic bodies. Prepared by STAR ceramic engineers who have specialized in the development of specific formulae to meet the needs of the electronic and other industries. If you have a design or production problem involving porcelain, call on STAR engineers for an economical, practical solution.

- ★ HUMIDOLAIN
- ★ LAVOLAIN
- ★ THERMOLAIN
- ★ VITROLAIN
- ★ NU-BLAC
- ★ COMMERCIAL WHITE

the STAR PORCELAIN COMPANY
49 MUIRHEAD AVENUE TRENTON, N. J.



of test equipment and electronic instruments. William Kiselewsky and Steve Ikker, formerly chief engineer and production manager respectively of the Video Industry Products Co., hold similar positions in Tel-O-Tube's new division.

CBS-Columbia Inc., New York, N. Y., has announced a five million dollar expansion program with the purchase of approximately 275,000 sq ft additional manufacturing space for the production of tv and radio receivers. With the company's present manufacturing facilities in Brooklyn, the new plant, located in Long Island City, N. Y., will make available a total of over 500,000 sq ft of manufacturing space for civilian and military production requirements.

A new wing providing approximately 7,000 sq ft of floor space is being added to the dry-type air-cooled transformer plant of Acme Electric Corp., Cuba, N. Y. A battery of coil-winding machines is being installed to produce wound coils completely insulated and taped for hand finishing and testing operations.

National Research Corp., Cambridge, Mass., will build additional plant facilities on Charlemont St., Newton, Mass. The new plant will be occupied by the equipment division. Complete machine shop, welding shop and electronic assembly facilities are planned as well as accommodations for the engineering and drafting departments.

Fifteen Appointed to Executive Posts

IN A further expansion of Philco Corporation's divisionalization program and to handle the greatly increased volume of industrial and government electronic production, Joseph H. Gillies has been appointed vice-president and general manager of the Government and Industrial Division. He had been a director of Philco since 1947.

At the same time, William J. Peltz, who had been manager of government and industrial operations, was appointed vice-president—operations of the Television and Radio Division, Philco Corp.

Appointment of Larry LeKash-



G AIR

FOLDING CARTONS

Sell on Sight!

Smartly designed and brilliant multicolor Folding Cartons by G AIR are solving packaging problems for many manufacturers who are as meticulous about their packaging as they are about their famous products.

Sales, profits and prestige are increased with the SELL-ON-SIGHT magic of G AIR MULTI-COLOR CARTONS.

WRITE TODAY for samples and technical information.



*Pat. U. S. Pat. Off.

ROBERT G AIR COMPANY, INC.

155 EAST 44TH STREET, NEW YORK • TORONTO
PAPERBOARD • FOLDING CARTONS • SHIPPING CONTAINERS

BIRTCHEER TUBE CLAMPS

Hold Tubes in Sockets
under all Vibration,
Impact and
Climatic
Conditions

83
VARIATIONS
FOR
STANDARD
TUBES



NEW
CLAMP
FOR
MINIATURE
TUBES

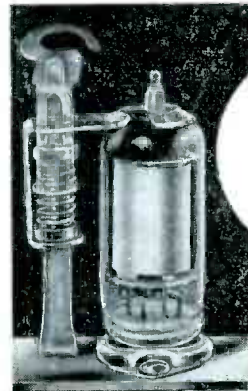

You can't shake, pull or rotate a tube out of place when it's secured by a Birtcher Tube Clamp. The tube is there to stay. Made of Stainless Steel, the Birtcher Tube Clamp is impervious to wear and weather.

BIRTCHEER TUBE CLAMPS can be used in the most confined spaces of any compact electronic device. Added stray capacity is kept at a minimum. Weight of tube clamp is negligible.

Millions of Birtcher Tube Clamps are in use in all parts of the world. They're recommended for all types of tubes: glass or metal—chassis or sub-chassis mounted.

THERE'S A BIRTCHEER TUBE CLAMP FOR EVERY STANDARD AND MINIATURE TUBE!

Write for samples, catalogue and price lists.

THE BIRTCHEER CORPORATION
4371 Valley Blvd.
Los Angeles 32, Calif.

Electronics Mfrs... See Birnbach!



Cut production costs, speed operations, by specifying BIRNBACH—your DEPENDABLE Source of Supply!

COMPLETE WAREHOUSE STOCKS
Write for Catalog 52

For All Your Needs in
Radio - Electronic - Television

- Gov't Specification
- Hook-Up Wire SRIR-SRHV JAN-C-76 Thermoplastic WL-Glass Braid 105° C. UL Approved
- Wire—Cable
- Guy Wire
- Aluminum Wire
- Magnet Wire
- Jacks—Plugs
- Insulators Steatite-Ceramic
- Hardware
- Accessories
- Test Leads
- Vinyl Extruded and Radio Grade Tubing

BIRNBACH RADIO CO. INC.
145 HUDSON STREET
NEW YORK 13, N. Y.

Manufacturers of Quality Products
for the Electronics Industries—
Serving since 1923



WASHERS—ALL KINDS



WASHER SPECIALISTS for nearly half-a-century. Dies in stock will produce most sizes. Big runs made with automatic presses. An economical, accurate, and highly reliable source for washers, also all kinds of metal stampings. HAVE WHITEHEAD'S CATALOG ON FILE; write for it.

BEVELED
CUP
D-HOLE
RETAINER
LOCK
SPACERS
SPRING TENSION
SQUARE HOLE
STAR LOCK
THRUST
TONGUE



EST.
1903

WHITEHEAD STAMPING COMPANY

1691 W. LAFAYETTE

• DETROIT 16, MICH.

**Try Remler for Service-Tested
"Hard-to-Get" Components**



TYPE 50
4-pin socket

TYPE 56
octal socket

**Custom
Components**

Metal-plastic components designed and manufactured to order. Write for quotations specifying electrical and mechanical characteristics. Describe application. No obligation.

**REMLER
TUBE SOCKETS**

● STANDARD FOR 30 YEARS...
THE BEST IN THE INDUSTRY

Heavy duty phenolic sockets with high current wiping action contacts... for industrial, transmitter and test applications. Rugged. Years of tube insertions and withdrawals do not impair contact effectiveness. Black phenolic is standard, low loss phenolic or alkyd on order.

Remler Company Ltd. 2101 Bryant St. San Francisco 10, Calif.

NEWS FROM THE FIELD (continued)

man as a vice-president of *Electro-Voice*, Buchanan, Mich., has also been announced. He was formerly with *RCA* and prior to that was vice-president and general manager of *Radio Magazines, Inc.*

Directors of *Webster-Chicago Corp.* have elected Gus W. Wallin to the newly created position of vice-president in charge of engineering. Wallin joins the company after eleven years with *Motorola, Inc.*, most recently in charge of that firm's military engineering. He holds a number of patents in radio and tv circuits and design and has served as co-chairman of the NTSC panel on color tv and on the FM receiver committee of the RTMA.



G. W. Wallin

H. A. Gumz

H. A. Gumz, production manager of *Webster-Chicago Corp.*, has been named vice-president of the firm. He will be responsible for following through on all government orders from receipt to final delivery.

Other recent executive appointees with their companies are as follows:

Harold C. Weingartner, vice-president and general manager of the equipment division of *National Research Corp.*, Cambridge, Mass.; John W. Belanger and Nicholas M. DuChemin, vice-presidents of *General Electric Co.*, Schenectady, N. Y.; Robert L. Werner and Ernest B. Gorin, vice-presidents of *RCA*; Raymond S. Perry, vice-president and director of *Federal Telephone and Radio Corp.*, Clifton, N. J.; Jerry A. Matthews, Jr., vice-president in charge of manufacturing at *Edo Corp.*, College Point, L. I., N. Y.; Carl E. Scholz, vice-president and chief engineer of the *American Cable & Radio Corp.*; George I. Long, vice-president and general manager of *Ampex Electric Corp.*, Redwood City, Calif.; and Anthony H. Lamb, vice-president in charge of manufacturing at *Weston Electrical Instrument Corp.*

Remler
Since 1918 PIONEERS IN ELECTRONICS AND PLASTICS

FOR THOSE TIGHT SPECIFICATIONS



**Miniature
POWER
RESISTORS**



**EVERY DESIRABLE
CHARACTERISTIC**

- Smallest in size.
- Sealed in Silicone.
- 100% impervious to moisture and salt spray.
- Complete welded construction from terminal to terminal.
- Temperature coefficient 0.00002% per degree C.
- Ranges from .05 Ohms to 55,000 Ohms, depending on type.
- Tolerance .1%, .5%, 1%, 3%, and 5%.
- RH Types—Silicone sealed in a die-cast, black anodized radiator finned housing and mounts on sub-panel for maximum heat dissipation.
- Prompt Delivery.
- Let us quote on your immediate needs.

Phone, wire or write George Risk
Telephone 2139—2500 13th Street
For Price & delivery

(We also manufacture deposited carbon resistors)

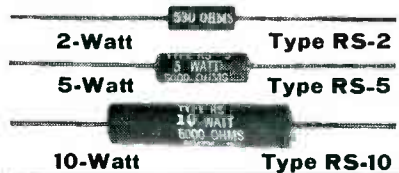

"DALOHM"

**MINIATURE PRECISION
RESISTORS**

MANUFACTURED IN
ACCORDANCE TO
JAN-R-26A Specifications
Characteristic G'

DALE PRODUCTS, INC. Columbus, Nebraska

VULCAN

ELECTRIC HEATING UNITS

FINNED STRIP

For use in blower type electric unit heaters, as oven or space heaters in dryers, pump rooms, switch towers, etc.

From 10½" to 42½" overall. 500 watts to 3250 watts. for 115 and 230 volts

Steel sheath and fins (rust resisting)

For use where sheath temperature will not exceed 750° F.

VULCAN

ELECTRIC COMPANY
DANVERS 10 MASS.

VULCAN

Matchless precision in miniature slip ring assemblies and commutators

for synchros, gyros, computers, resolvers, instruments and selsyns

32 circuits in one inch

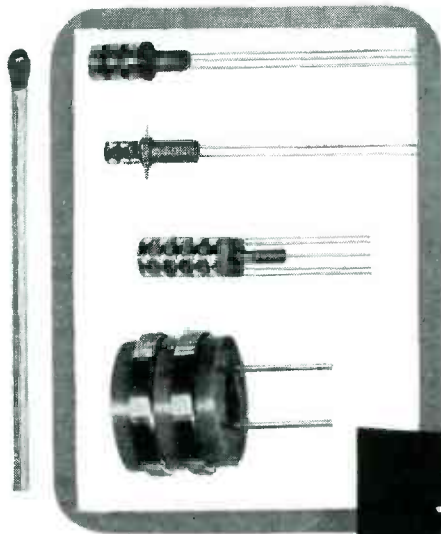

Airflyte

ELECTRONICS COMPANY
21 COTTAGE ST., BAYONNE, N. J.

WRITE

SENIOR ENGINEERS

Opportunities Western Connecticut

Opportunities for personnel experienced in the following fields. Our present operations require us to be concerned with the following materials, processes, specifications and equipment: Fosterite, Hermetically sealed transformers, Casing resins, Vacuum impregnation, MIL-T-27 and AN-E-19, Precision testing equipment, Oil filling.

Our record of over 40 years of successful business operation indicates the security of this company.

If you are experienced in the design of audio transformers, power transformers, reactors, pulse transformers, please send resume to Director of Personnel,

THE WHEELER INSULATED WIRE CO.
Division of Sperry Corporation
150 E. Aurora St., Waterbury, Conn.

NEWCOMB THE SOUND CHOICE OF ENGINEERS



The flawless workmanship, superb operational features and the unsurpassed performance of the distinguished Newcomb amplifiers, excite the admiration of even the most case-hardened engineer. Judged by the most critical standards they more than measure up to your fondest expectations. The brand you can most confidently recommend, or use in your own installations . . . the industry's most complete sound line.

Write for information

*The sound line
that quality built*



NEWCOMB AUDIO PRODUCTS CO.

Dept. L, 6824 Lexington, Hollywood, Calif.
AMPLIFIERS, SYSTEMS, RACK EQUIPMENT,
TRANSCRIPTION PLAYERS, PHONOGRAPHS

DID YOU GET IT? IF NOT
**SEND NOW FOR B-A's
136 BIG PAGE
FREE CATALOG**

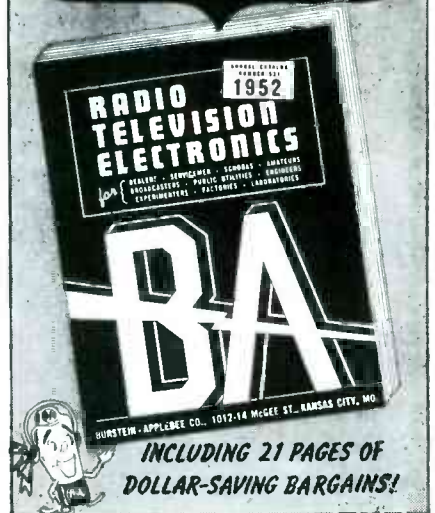

BURSTEIN-APPLEBEE CO.
1012-14 McGee St.
Kansas City 6, Mo.

FREE

Send your 1952 catalog to:

Name.....
Address.....
City..... State.....

BURSTEIN-APPLEBEE CO.



NEW COMPONENTS



HRT-O
DIAL



HRM
KNOB



VD-16 KNOB



IFR (455 kc)
IFS (1720 kc)
I.F. TRANSFORMERS

Pictured above are some of the new items we have added to our line of quality components. They have been especially designed to meet new and changing needs in electronics and, like all National components, are made better than industry standards. Write for drawings and specifications.

Address export inquiries to Export Div.,
Dept. E-252



NEW BOOKS

Advanced Engineering Mathematics

By C. R. WYLIE JR., *Professor and Chairman, Department of Mathematics and Astronomy, University of Utah.* McGraw-Hill Book Co., Inc., New York, 1951, 640 pages, \$7.50.

A COMPLETE course in advanced mathematics is presented in unusually clear and concise form. The first half of the book deals in differential equations, Fourier series and integrals, the Laplace transform and Bessel functions. The third quarter covers functions of complex variables, including integration in the complex plane, residues and conformal mapping. The last part presents vector and numerical analysis. An appendix of 63 pages is so organized and so cleverly condensed as to provide a complete review of pertinent background material.

The book is outstanding in several respects. Most of the material presented is explained by practical examples with well-organized steps and clear explanations. A great deal of teaching before a class and answering questions is reflected in the author's writing.

"Advanced Engineering Mathematics" is strongly recommended as text book or reference for advanced students in electrical engineering.
—J.F.

Fundamentals of Electronics

By F. H. MITCHELL, *University of Alabama.* Addison-Wesley Press, Inc., Cambridge, Mass., 1951, 243 pages, \$4.50.

A ONE-SEMESTER text designed for two purposes: to lay the ground work for more advanced courses in electronics, and to give nonelectronics students a feel for electronic measuring apparatus and techniques, something they are certain to cope with somewhere along their march from college to technical competence in their chosen field, whatever that may be. The emphasis throughout is on the tube as a measuring tool and the choice of contents has been governed by this viewpoint.

The many basic tube circuit combinations are treated, after

"Just tell them they CAN'T AFFORD TO USE ANYTHING ELSE . . ."

That's Joe Gibbons speaking. We were talking about how to make people realize what a terrific thing this new

JELLIFF ALLOY 1000 RESISTANCE WIRE

really is, and that's the way he summed it up. And even when you make allowances for a salesman's natural enthusiasm, he's pretty near right. Just look at some of the important data:



Resistivity 1000 ohms/cm
Tensile strength 165,000 psi—
TC of Resistance 20 ppm—
Coefficient of Expansion 13.9 ppm—
Corrosion Resistance equal to the best nickel-chromiums—
Winds fast and solders easily—
Lots more ohms in lots less space.

See what we mean? For the whole story, write for Bulletin 17.

Get practical help
from these
McGRAW-HILL BOOKS

**AUTOMATIC
FEEDBACK CONTROL**
Just Published!

1. Gives information needed for the design and selection of automatic feedback control apparatus. Covers operation of controls and problems encountered in industries. Shows functional and constructional requirements of instruments. Covers servomechanisms, pneumatically operated controls, temperature regulation, speed governing, pressure, flow, and liquid level. By William H. Ahrendt, Pres. Ahrendt Instrument Co., and John F. Taplin, Consulting Engin., Kendall Controls Corp. 420 pages, 378 illus., \$7.50

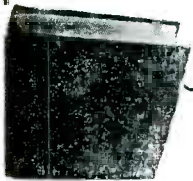

**ADVANCED
ENGINEERING
MATHEMATICS**
Just Published!

2. Provides a reference and guide on the branches of mathematics which the engineer must understand and use in his daily work. Covers ordinary differential equations, with particular emphasis on linear equations with constant coefficients; Fourier series; operational calculus; separable partial differential equations and associated boundary value problems; functions of a complex variable; vector analysis; and various numerical methods. A special chapter provides data and information on mechanical and electrical vibrations. By C. R. Wylie, Chairman, Dept. of Math., Univ. of Utah, 640 pages, 105 illus., \$7.50

**QUANTUM THEORY
OF MATHEMATICS**
Just Published!

3. Deals first with the general principles of quantum mechanics, starting from the beginning and presupposing a moderate knowledge of atomic structure and mathematical physics. Then discusses the structure of atoms, molecules, and solids, with attention to such properties as atomic spectra, intermolecular forces, band theory of solids, electrical conductivity, semiconductors, dielectric and magnetic effects. Treats the theory of atomic multiplets, molecular structures, ferromagnetism, etc. By John C. Slater, Prof. of Physics, Mass. Inst. of Tech. 528 pages, 134 illus., \$7.50



**HIGH FREQUENCY
MEASUREMENTS**

4. Here is up-to-date reference material for experiments being carried on in radio as well as electronics. Discusses many procedures for measuring practical units such as amps, watts, volts, m², etc., to enable you to decide which procedure to use for a specific problem. Describes measurements for short-waves, lines and antennas, and for a-m, p-m, and f-m. By August Hund, Scientific and Tech. Radio Consultant, 2nd Ed., 676 pages, 417 illus., \$10.00

SEE THESE BOOKS 10 DAYS FREE

McGraw-Hill Book Co., 330 W. 42 St., NYC 18

Send me book(s) checked below for 10 days' examination on approval. In 10 days I will remit for book(s) I keep, plus few cents for delivery, and return unwanted book(s) postpaid. (We pay for delivery if you remit with this coupon; same return privilege.)

- 1. Ahrendt & Taplin—AUTO. FEEDBACK CONTROL\$7.50
- 2. Wylie—ADVANCED ENGINEERING MATH.\$7.50
- 3. Slater—QUANTUM THEORY OF MATH.\$7.50
- 4. Hund—HIGH FREQUENCY MEASUREMENTS\$10.00

(Print) Name

Address

City, Zone, State

Company

Position, FL-2-52

This offer applies to U. S. only

HUGHES

Research and Development

Laboratories

Invites inquiries from

Engineers and Physicists

*Hughes Aircraft Company
Culver City, California*

ASSURANCE IS REQUIRED THAT RE-LOCATION OF THE APPLICANT
WILL NOT CAUSE DISRUPTION OF AN URGENT MILITARY PROJECT.

Sapphire and Glass

JEWEL BEARINGS

Performance proved for precision and long life by world's leading makers of electrical, aircraft and timing instruments; compasses; weather recorders; all testing, indicating and recording apparatus.

Unset or set in screws or bushings to suit requirements. Write for brochure.

Quality controlled



Serving industry
with fine jewels
since 1913

Richard H. Bird & Co., Inc.
1 Spruce Street, Waltham, Mass.

**Now—A TIME PROVED VARIABLE with
JOHNSON STANDARDS**

TYPE "R" CONDENSERS ★ Capacity range 20 to 320 mmf. ★ Nickel plated brass plates .0226" ★ Spacing .020", .060" and .080"
★ Full soldered construction ★ 1/4" brass shaft and heavy brass end plates nickel plated
★ Steatite insulation ★ Silver plated beryllium copper rotor contact ★ Uniform torque.



AVAILABILITY: Plant capacity still available for production quantity orders. If you lack commitments on your unfilled requirements, perhaps we can help.



E. F. JOHNSON CO.

Waseca, Minnesota

need GYROS ?



Giannini makes them
FREE • VERTICAL • DIRECTIONAL • RATE

Write us about your gyro problems, both A. C. and D. C.

G. M. GIANNINI & CO., INC.
Pasadena 1, California

Giannini

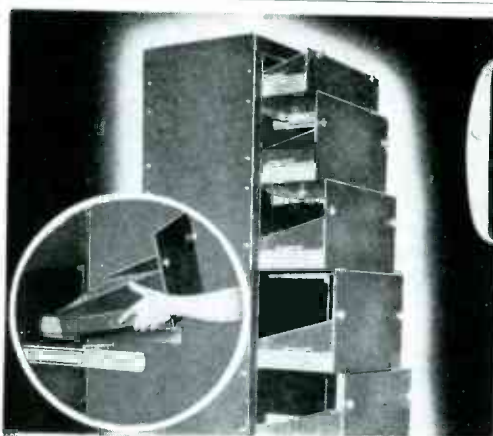

Note simple unit removal possible when unit is mounted on Grant Electronic Slides. Chassis can be easily re-inserted.

GRANT

Electronic Slides

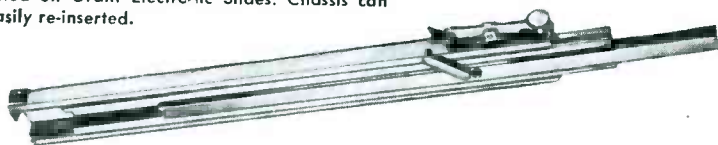

Cat. No. 371

Three section slide, progressive action type. Can lock in closed and extended positions or any other combination of positions. Thumb release controls unlocking. Load Capacity: 200 Lbs./pr.

Grant's Engineering and Research Departments are available for consultation on individual requirements.

GRANT PULLEY & HARDWARE CO.
31-85 Whitestone Parkway, Flushing, L. I.

The foremost name in Sliding Devices



which those special combinations useful in instruments are discussed. Thus the diode as a rectifier, the multielement tube as an amplifier of voltage, current and power, and the peculiar properties of gas-filled tubes have individual chapters. These accompany chapters on sine-wave oscillators, special-purpose tubes (electrometers, ionization gages and electron multipliers) wave-shaping and control circuits and, of course, the many phases of vacuum-tube voltmeters and cathode-ray techniques.—K.H.

Elements of Television Systems

BY GEORGE E. ANNER. *Prentice-Hall, Inc., New York, 1951, 804 pages, \$10.35.*

THIS excellent volume offers the most comprehensive treatment of television techniques currently available. Written primarily for use in college courses by Professor Anner of N.Y.U. this book is the eighteenth to appear in the Electrical Engineering Series edited by W. L. Everitt. It maintains the high standard set by the previous volumes in the series. The illustrations are copious and well chosen.

The book is cast in three sections. The first consists of eight chapters on "closed systems", that is, systems not containing a radio-frequency link. Standards of transmission, scanning methods and generators, picture tubes, camera tubes, and video amplification are treated here in comprehensive fashion.

The second part discusses the commercial telecasting system, bringing into focus those parts not previously treated. The factors underlying the choice of number of lines for commercial use, synchronization methods, vestigial sideband transmission, picture transmitters, home receivers, and antennas are included, as well as a chapter on stagger-tuning of i-f amplifiers and one on televising film. The final part is devoted to color television, describing the CBS, CTI and RCA systems as presented in 1949-50 to the FCC.

This is a thoroughly practical book, although written primarily



development
and production

METALLURGISTS

BASE, RARE AND PRECIOUS
METALS AND ALLOYS

SMALL UNITS
SMALL SIZES
CLOSE TOLERANCES

Nickel alloy, filament wire and
ribbon: flat, grooved, crowned.

Grid wire electroplated.

Alloys for special requirements,
bare or enamelled.

Further details upon request.

SECON

METALS CORPORATION
228 East 45th Street, New York 17, N. Y.
Murray Hill 7-1594

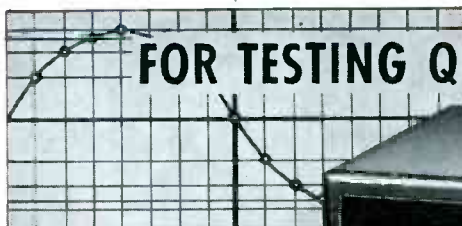

FOR TESTING QUADRATURE DEVICES

THE NEW ACME MODEL S-561



QUADRATURE GENERATOR

Designed to supply signals of extremely low distortion and of very exact quadrature for testing phase sensitive devices, this ACME S-561 Quadrature Generator has proven accurate to a degree heretofore impossible.

This instrument supplies various 400 cycle A.C. voltages with phase relationship of 90° plus or minus 1° and with extremely stable signal frequencies. The Generator comes complete with its own external power supply.

This special purpose device which is used for testing discriminator circuits or other devices dependent on quadrature voltages can be modified to meet other test requirements. For complete information, write us your specifications.



Acme

ELECTRONICS, INC.

300 No. Lake Ave., Pasadena 4, Calif.

Wave Filters • Delay Lines • Magnetic Amplifiers • Special Transformers & Chokes • Toroidal, Universal & Solenoid Wound Inductors

The New STAVER MINI-SPRING

TRADE MARK REG. AND PAT. PEND

Available!
Special
Improved
Types for
Military
Apparatus



Gives support two ways—Keeps pressure downward and gives sideway support. The spring action is constant and resilient permanently. Send for catalog sheet.



NOW! ELECTRO-TECH'S

OFF-THE-SHELF SERVICE

can save months
on your schedule



ONE SOURCE OF SUPPLY
for all kinds of ELECTRICAL
METERS, INSTRUMENTS and
INDUSTRIAL CONTROLS

No need to hold up production for lack of a meter, controller or other instrument! Electro-Tech's warehouse is bulging with panel meters, solenoids, transformers, rectifiers, timers, counters and every other kind of meter and control device.

Plus—complete laboratory facilities to convert, repair and re-scale stock meters and instruments to fit your needs.

- SIMPSON
 - WESTON
 - STRUTHERS-DUNN
 - MICRO SWITCH
 - SUPERIOR ELECTRIC
 - GENERAL ELECTRIC
 - WHEELCO
- and others

FREE! Write today for the big, useful Electro-Tech BUYER'S GUIDE.

ELECTRO-TECH
EQUIPMENT COMPANY, Dept. E-2
308 Canal Street, New York 13, N. Y.



**Priced
Right!**

WIRE FORMS

& Metal Stampings

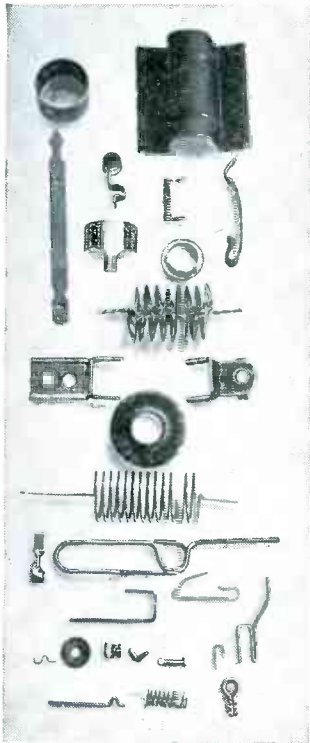

High-speed, quality production with custom-made precision. Wire formed in any shape for every need.

**IMMEDIATE CAPACITY FOR
DEFENSE SUB-CONTRACTS
STRAIGHTENING & CUTTING**

Perfect straight lengths to 12 ft.

.0015 to .125 diameter

WIRE FORMS

.0015 to .080 diameter

SMALL METAL STAMPINGS

.0025 to .035 thickness

.062 to 3 inches wide

Specializing in Production of Parts
for Electronic and Cathode Ray Tubes

Write for illustrated folder.

Send Blueprints or Samples
for Estimate.



ART WIRE and STAMPING COMPANY

1 BOYDEN PLACE
NEWARK 2, N. J.



MODEL 200-A DC MILLIVOLTMETER

DC Measurements

5 MICROVOLTS

to

10 VOLTS

A precision converter, that changes the input DC into an amplified, sinusoidal AC Voltage

- 5 Microvolts internal noise
- 2 Megohms input resistance
- Stabilized gain and zero
- Insensitive to power line pickup

Makes the AC Vacuum tube Voltmeter direct reading in DC microvolts and millivolts.

With the cathode ray oscillograph yields an extremely sensitive DC null detector.

DESCRIPTIVE LITERATURE ON REQUEST TO DEPT. E-2



INDUSTRIAL CONTROL COMPANY

Wyandanch Long Island, New York

for academic consumption. Circuits are described in detail on the basis of physical operation, as well as from the theoretical standpoint. Liberal use is made of mathematics likely to be possessed by the senior in engineering courses, including calculus and transient analysis, but the descriptions of apparatus are self-contained so that benefit can be derived without a working knowledge of mathematical aids.

The bibliography is adequate, as are the subject and name indexes. Nearly 200 problems, covering all chapters except three, are collected at the end of the book. These are for the most part of senior-college difficulty.

Professor Anner evidently knows the whole field of technical television very well, is thoroughly familiar with the periodical literature, and has the faculty for organizing his material and presenting it clearly. He has produced a very worthwhile text which should meet an as-yet-unfilled need among senior and graduate students.

There are a few shortcomings. The material on color systems is, inevitably, out of date so far as compatible systems go. This is, of course, no fault of the author and can be corrected in a subsequent printing after the NTSC development is stabilized. The omission of numerical answers to the problems is a serious disadvantage for the reader who must study the book by himself. The highly mathematical flavor may prove a stumbling block for practicing engineers, five or more years out of college. But the book was not written for such as they. It is a textbook and a good one.—D.G.F.

Fundamentals of Radio Communications

BY ABRAHAM SHEINGOLD, *U. S. Naval Postgraduate School. D. Van Nostrand Co., Inc. New York, 1951, 442 pages \$5.25.*

THIS is essentially a nonmathematical text of an intermediate level for students in colleges and technical schools. It includes a short refresher on d-c and a-c circuits and circuit analysis plus general material on the basic components—re-

Solderless Cable Fittings

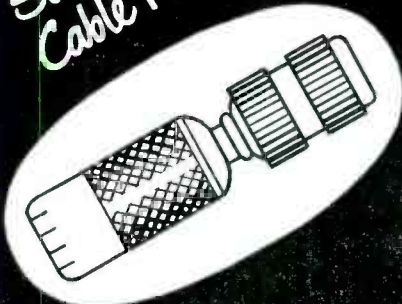

WORKSHOP provides a complete line of solderless cable fittings for RG-59/U, RG-11/U and RG-8/U coaxial cables—all in current production and available in large quantities. Pictured above is the W-50 male cable connector, silver plated and specially slotted to withstand strain. Write for catalog and complete specifications.



THE WORKSHOP ASSOCIATES

Division of the Gabriel Co.
135 Crescent Road
Needham Heights 94, Mass.

for EMERGENCY



for CONVENIENCE



SOUND POWERED INTERCOM and TEST SYSTEMS



by WHEELER

- No auxiliary power is required
- Operates over two conductor full metallic or single wire, ground return circuit
- Satisfactory operation up to 25 miles with #16 twisted; up to 15 miles with #19 twisted
- Explosion proof
- No spark or fire hazard is generated
- High fidelity speech transmission
- 12 handsets can be incorporated in communication system for group conversation

MANUFACTURED BY
The WHEELER INSULATED WIRE Co., Inc.
A DIVISION OF THE SPERRY CORPORATION



Niagara

Digby 9-1132-5-4

160 Greenwich Street, New York 6, N. Y.

RADIO SUPPLY CORP. Dept. 2-E

after you've read this magazine

... and clipped pertinent ideas, articles and advertisements for reference, please do not burn or throw it away.

Here are two sound reasons why:

1) Wastepaper can help to swell the funds of your local Boy Scout Troop, your church or other community organization. It gets a good price these days.

2) Whether in magazine form or not, wastepaper helps to fill the increasing need for paper pulp brought on by the mobilization effort.

Collect it. Give it to your favorite organization. Chances are they have scheduled pickups.

Depend on... Unicon

CAPACITORS

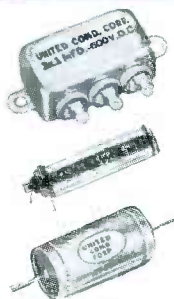

Take no chances with ordinary capacitors — INSIST ON UNICON oil impregnated, hermetically sealed Capacitors. Made to meet JAN-C-25 specifications. Specially designed for severe military and tropical service.

We also specialize in minaturization of 125°C capacitors meeting CP 10 and 11 requirements.

Catalogs and Quotations on Request!

UNITED CONDENSER CORP.

337 E. 139th St., N. Y. 54, N. Y.

- Oil Impregnated
- Vacuum Filled
- Hermetically Sealed
- Non-Corrosive Containers
- Made to JAN Specs.

SPECIFICATION

AN-P-89

PANELS - DIALS - ETC.

BODNAR INDUSTRIES, INC.

19 RAILROAD AVE., NEW ROCHELLE, N.Y.

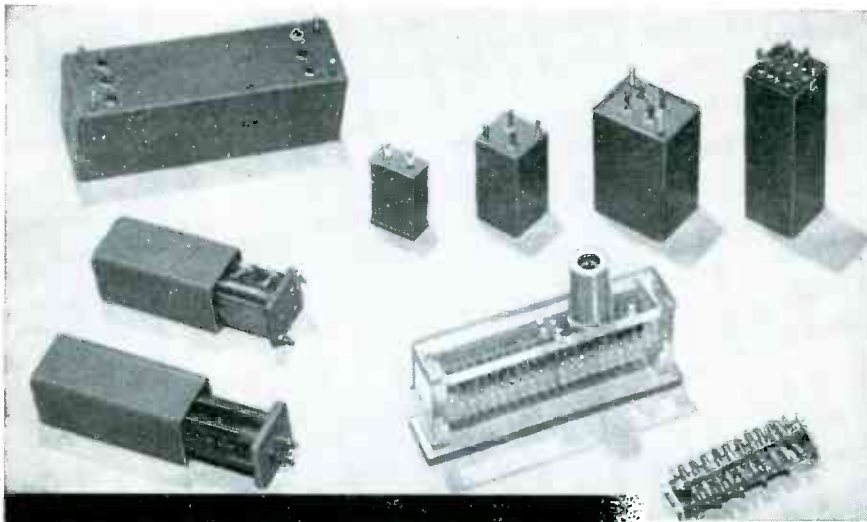

DELAY LINE NETWORKS



Our facilities are organized for design, development and production of delay lines in any quantities.



Your standards are observed in the design stage, prototype development and throughout the entire production run. We meet all JAN specifications when required. Our design assures you maximum engineering efficiency in a minimum space.

Our delay lines are made to special order only. Write for brochure DL-181.



Electronic Systems Co.

578 EAST 161st STREET • NEW YORK 56, N. Y.

DELAY LINES • PULSE TRANSFORMERS • NETWORKS

sistance, inductance and capacitance, out of which all radio circuits are made. The manner in which these elements are combined to produce selective circuits of the resonant or iterative types or to transfer power is covered in two chapters, followed by chapters on the generation and propagation of radio waves, fundamentals of electron tubes and functions of tubes.

The up-to-date nature of this text can be gathered from the fact that it contains chapters on pulse circuits, uhf techniques and the important navigation systems now in use.

The book is well produced and easy to read and should be a useful first text in a field which is ever-changing.—K.H.

Semi-Conducting Materials

EDITED BY H. K. HENISCH. *Academic Press, Inc., New York, 1951, 281 pages, \$6.80.*

IN JULY, 1950, a conference was held at the University of Reading on the subject of Semi-Conducting Materials. This conference was sponsored by the International Union of Pure and Applied Physics in cooperation with the Royal Society, and was organized by Professors R. W. Ditchburn of Reading and N. F. Mott of the University of Bristol. The volume under review constitutes the proceedings of this conference and contains in full the 28 papers presented.

Many of the papers discuss material that was new at the time of the conference, some of which had not come to this reviewer's attention before reading this book. As might be expected, a considerable amount had previously appeared as scattered papers read at meetings and as communications. We hasten to add that, in such cases, the Reading papers bring together the previous reports in such fashion that a much clearer picture is nearly always presented.

Results of the work done on semi-conductors during and since World War II and discovery of the transistor effect have served to widen enormously the interest and activity now being devoted to these mate-

SAVE CRITICAL MATERIALS

with "IMPROVED QUADRUPLETS"

"BIRON" - Brass on Iron — "CIRON" - Copper on Iron
"NIRON" - Nickel on Iron — "SIRON" - Silver on Iron

Your supply and allotment of critical materials will last longer and go further this "IMPROVED" way. The bulk of the material is non-critical iron and the surface is the metal you require.

Enjoy *all* the advantages that the surface metal provides along with the savings of materials plus the strength and durability of the iron base. All are available in sheet or wire form and in any combination of metals made to your specifications.

Write today for full information.

We invite you to send for a free copy of our brochure, "The Story of Laminated Metals."

The Home of IMPROVED Service

The IMPROVED SEAMLESS WIRE COMPANY

INCORPORATED 1898

775 Eddy Street, Providence 5, Rhode Island

rials, not only upon the part of physicists but also upon the part of an ever-widening portion of the engineering profession. While the papers were, in general, written by and for specialists in the field of solid-state physics, it is safe to assume that "Semi-Conducting Materials" will be found both interesting and helpful to a large number of readers.

In this connection it may be of interest to quote one of the papers, that by Scott and Mayer: "Germanium, silicon, and other amphoteric semiconductors appear to be following a similar course of evolution"—to that of selenium—"in that the chemical (metallurgical) problems are well to the fore at present. However, in such cases physical theory, developed rapidly in the last year or two, has opened up the field in such a way that much more rapid progress may be expected. The physical side is likely to make even more spectacular advances when the chemistry of these materials is further clarified."

The same writers also quote Frederick Seitz as having said that "there is still a chance that the field of solid-state physics will be claimed by chemistry and electrical engineering." In the year and a half that has elapsed since the Reading Conference, the rate at which activity in semiconductor work has increased in the fields of chemistry, metallurgy and electronics overwhelmingly bears out the trends foreseen.

Scope of Papers

It is interesting to note that ten of the papers were written by Americans, ten by British and the remainder by Continental authors. Of the American papers, more than half are concerned with the properties of silicon and germanium; this may be taken as an indication of the impetus given to the study of these materials through government and industrial interest in the crystal diode and the transistor. Interest in silicon and germanium and in the transistor is not, of course, confined to this side of the Atlantic. Work on semiconductors in Europe does, however, seem to be somewhat more diversified and with greater



"it's easy to bend"

a new practical 32 Page diacro BENDING MANUAL

by the originators of "Die-less Duplicating"

This instructive and authoritative booklet will quickly prove itself indispensable wherever bending is done or is needed. It brings you a veritable gold mine of tested, authentic bending methods applicable to any rotary type bender. The proper bending technique may frequently offer a new approach to an old problem by simplifying product design and cutting production costs.

The exact methods of producing various types of bends in a wide range of materials are illustrated, step by step, with over 90 diagrams and charts together with valuable tooling suggestions.

**You'll want a copy . . .
Mail your request today.**

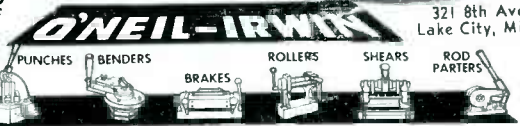

321 8th Ave.
Lake City, Minn.

VSWR & RF WATTMETER

0.1—1200 Watts 30—2000 MCS.

MicroMatch

MM 700 SERIES

Measures RF Power and Standing Wave Ratio

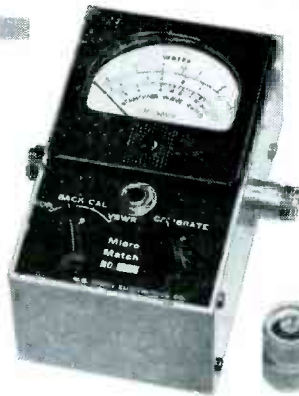

Light, rugged instrument for use in design, installation and maintenance of modern transmitter and antenna equipment. Measures RF power fed to a load and the VSWR of the load. Direct reading in watts and VSWR. No interference with transmitter or load. Please write for descriptive bulletin.

SPECIFICATIONS

FREQUENCY RANGE—30 to 2000 MCS.
 IMPEDANCE—51.5 OHMS
 CONNECTORS—Standard connectors supplied are type N to accept UG-21/U attached to RG-8/U or RG-9/U cable. The instrument is also available with Type C, HN, and UHF connectors.
 ADAPTERS—One type UG-57B/U adapter is supplied with each instrument having N type connectors.
 REMOTE INDICATOR—A remote indicator, Models 731 or 732, is available to provide meter readings at a remote location.

Power Ranges	Model No.	Remote Indicator Model No.
0 to 1.2 watts	MM-701	731
0 to 4 watts	MM-702	731
0 to 12 watts	MM-703	731
0 to 40 watts	MM-704	732
0 to 120 watts	MM-705	732
0 to 400 watts	MM-706	732
0 to 1200 watts	MM-707	732

ACCURACY—Plus or minus 5% of full scale for RF Power. Plus or minus 10% for standing wave ratio.
 REFLECTION COEFFICIENT—Negligible
 SIZE—3 1/8 x 5 1/4 x 3 3/8 WEIGHT—2 pounds



M. C. JONES
ELECTRONICS COMPANY
BRISTOL, CONNECTICUT

Distributed outside of Continental U.S.A. by RCA International Div., N.Y., N.Y., U.S.A.

WINCHESTER ELECTRONICS, INCORPORATED

NEW MINIATURE CONNECTORS

... for Airborne Electronic Equipment designed and manufactured by Winchester Electronics, Inc.

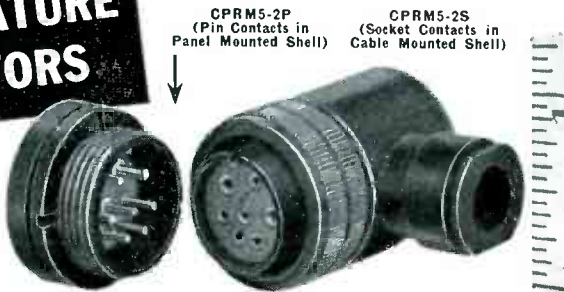

Recent designs for electronic equipment in aircraft and guided missiles have required progressive miniaturization of electronic components. The above connector is typical of several recent designs we have supplied to meet this need. We have given special consideration to the following features:

1. **Shell Enclosure** — Die cast aluminum alloy.
2. **Light Weight** — Total for plug and receptacle 1.5 oz.
3. **Small Size** — Maximum diameter 1". Total length O.A. 1 7/8".
4. **Right Angle Cable Entry** — For use in limited space.
5. **Pressure Tight** — Inserts, contacts and cable entry, individually sealed with neoprene "O" rings or special gaskets.
6. **Contacts**—Five for #20 A.W.G. and two for #18 A.W.G. wire.
7. **Finish** — Olive drab, iridite.

Other contact arrangements and shell designs will be available soon — Write our Engineering Department for complete details.

CPRM5-2P (Pin Contacts in Panel Mounted Shell)
CPRM5-2S (Socket Contacts in Cable Mounted Shell)

These connectors also employ standard Winchester Electronics features:

1. MONOBLOC* construction.
2. Molded Melamine (mineral filled) inserts.
3. Precision machined pin and socket contacts, silver plated with gold flash over.

*Trade Mark.

Let us help you with your difficult connector problems. Advise us of your special requirements.

WINCHESTER ELECTRONICS INCORPORATED

GLENBROOK, CONN., U.S.A.

REGULATED HIGH VOLTAGE POWER SUPPLY



Provides Electronically Regulated, Continuously Adjustable Voltages from 150 to 1500 VDC at 0-5 Milliamperes

This unit is specially designed to supply proper power for making precise quantitative measurements with photomultiplier tubes, klystrons and similar applications. Voltages are held to close limits even with wide line voltage and load variations. No meter is required. Accurate voltage readings are made directly from a 15 turn vernier dial which is calibrated to read 1 volt per scale division.

MODEL 810-P SPECIFICATIONS

- **OUTPUT VOLTAGE:** 150 to 1500 VDC at 0-5 Milliamperes.
- **REGULATION:** Output voltage varies less than .01% per volt change of line voltage and less than .1 volt with variation of output current from 0 to 5 Milliamperes.
- **RIPPLE:** Less than 5 Millivolts r.m.s.

Positive output terminal is grounded. 5 negative output connectors (type AN-3102A-18-16-s) are connected in parallel and mounted on front panel.

See the Model 810-P and other Furst Power Supplies at the I.R.E. Convention — Booth 363



Write for Descriptive Bulletin

FURST ELECTRONICS

10 S. Jefferson St., Chicago 6, Ill.

NEW BOOKS

(continued)

emphasis on semiconducting compounds.

The list of titles and authors follows:

- Semi-conductors, N. F. Mott
On the Energy States of Impurities in Silicon, G. W. Castellani and F. Seitz
New Phenomena of Electronic Conduction in Semi-conductors, W. Shockley
Semi-conductor Surface Phenomena, W. H. Brattain
Nucleon-bombarded Semi-conductors, K. Lark-Horovitz
Appendix I: Effect of Bombardment upon a Classical Semi-conductor in Thermal Equilibrium, V. A. Johnson and K. Lark-Horovitz
Appendix II: Fermi Levels in Bombarded Semi-conductors, H. M. James and G. W. Lehman
Crystal Triode Action in Lead Sulphide, P. C. Banbury, H. A. Gebbie and C. A. Hogarth
Recent Experiments on Lead Sulphide Contacts, H. K. Henisch and J. W. Granville
Electrical Characteristics and Anomalies of Germanium, P. R. Aigrain, C. R. Dugas and H. W. Etzel
Electron Traps and Electron Conduction in Irradiated Alkali Halide Crystals, R. W. Pohl
Motion of Electrons and Holes in Silver Chloride, L. P. Smith
Semi-conduction and Photo-conduction in Barium Oxide Crystals, R. L. Sproull and W. W. Tyler
Infra-red Optical Properties of Silicon and Germanium, H. Y. Fan and M. Becker
Work Function of Germanium, E. W. J. Mitchell and J. W. Mitchell
Oxidic Semi-conductors, E. J. W. Verwey
Some Properties of Mixed Lanthanum and Strontium Manganites, J. Volger
Electrical and Optical Properties of Zinc Oxide, P. H. Miller, Jr.
On the Properties of Semi-conducting Oxides, T. J. Gray
Electronic Properties of Grey Tin, G. Busch, J. Wieland and H. Zoller
Electrical and Optical Properties of Certain Sulphides, Selenides and Tellurides, R. A. Smith
Measurements of the Temperature-dependence of Conductivity and Hall Coefficient in Lead Sulphide and Lead Telluride, R. P. Chasmar and E. H. Putley
Some Experimental Studies of the Resistance and Electromotive Force of Selenium Blocking Layer Cells, A. E. Sandstrom
On the Thermo-electric Properties of Selenium, H. K. Henisch and M. Francois
Crystallization of Semi-metals and the Formation of Lattice Effects, H. Krebs
Engineering and Chemical Aspects of Semi-conductors, T. R. Scott and S. E. Mayer
Electrical Conductivity of Very Thin Metallic Films Evaporated in High Vacuum, N. Mostovetch and B. Vodar

A word of appreciation is due Dr. H. K. Henisch of Reading University, who served as Secretary of the Conference, for an especially competent job in the onerous task of editing the proceedings.

—GEORGE D. O'NEILL,

Head Solid State Section, Physics Laboratories, Sylvania Electric Products Inc.

THUMBNAIL REVIEWS

QUALITY-CONTROL HANDBOOK. Edited by J. M. Juran. McGraw-Hill Book Co., New York, 1951, 800 pages, \$10.00. Compilation, by many authors, of known principles and practices for achieving better quality at lower cost. Intended primarily for reference by engineers, supervisors and executives. Based on material originally used for training courses in industry. One entire chapter covers quality

The Largest Selling
LIGHTNING ARRESTER
At Any Price!

NO. AT102

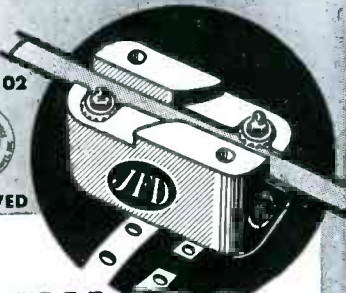

JUMBO

Protects Home and TV
Set Against Lightning
Hazards **\$225** LIST
U.S. Patent No. D-4664

- Installs anywhere
- No wire stripping, cutting or splicing

(Complete with strap and ground wire.)

OVER 1,000,000 IN USE TODAY!
See Your Jobber or Write for
Form No. 84



MANUFACTURING CO., Inc.
6145 B 16th AVENUE, BROOKLYN 4, N. Y.
FIRST in Television Antennas and Accessories

Engrave

... PANELS UP TO **25"** WIDE
IN YOUR OWN SHOP WITH THE
NEW ENGRAVOGRAPH

Portable Model 1-S

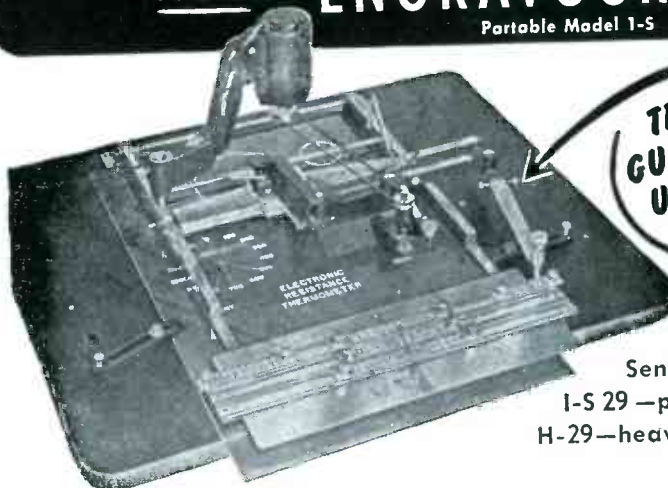

**TRACER
GUIDED FOR
UNSKILLED
LABOR**

Send for Booklets
1-S 29—portable model
H-29—heavy duty model

NEW HERMES, Inc. • 13-19 University Place, New York 3, N. Y.
CANADA: 359 St. James St., Montreal

Wanted . . .
**CHIEF MECHANICAL
ENGINEER**

Salary \$8,000 to \$10,000 start

This is a permanent position
with established electronic &
microwave equipment mfr.

Qualifications:

- (1) At least 10 years of senior design experience with precision mechanisms involving gearing, castings, cams and linkages that have been manufactured.
- (2) Knowledge of production tooling for short run and shop production methods.
- (3) Familiar with military specifications covering mechanical parts and instruments.
- (4) Creative ability for product design and development work.
- (5) Evaluate existing production designs for improvement and economy.
- (6) Direct and supervise a group of designers and detailers.
- (7) Must be willing to assist and execute designs on drafting board.
- (8) Must be U. S. Citizen.

LOCATION—BROOKLYN, N. Y.
SUBWAY TRANSPORTATION

Liberal benefits including
Hospitalization, Life Insurance
Sick Leave. Paid vacation

Send complete resume.

P-2765, Electronics
330 W. 42 St., New York 36, N. Y.

new hermes
Engravo
graph

- The only portable machine which reproduces 15 sizes from one master alphabet.
- The only one with adjustable copy holding slides for multiline engraving in one set-up.
- Self-centering holding vise for nameplates and dials.

NEW HERMES, Inc. • 13-19 University Place, New York 3, N. Y.
World's Largest Manufacturer of Portable Engraving Machines

FS

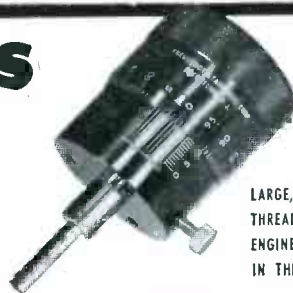

MICROMETER HEAD
for the Electronics Industry

LARGE, LEGIBLE, EASY TO READ CALIBRATIONS, PLUS A THIMBLE STOP TO PREVENT THREAD JAMMING, ARE FEATURES FOUND IN FS MICROMETER HEADS WHICH HELP ENGINEERS SPEED UP THEIR WORK. THESE AND MANY OTHER FEATURES ARE DESCRIBED IN THE NEW BULLETIN ON FS MICROMETER HEADS, OBTAINABLE ON REQUEST.

FREQUENCY STANDARDS

P. O. BOX 66, EATONTOWN, N. J. • TELEPHONE ASBURY PARK 1-1018

3

FOR LONG LIFE IN
LOW AMPERAGE CIRCUITS
THE SERIES 4000 S.P.S.T.
MOMENTARY CONTACT PUSH-
BUTTON SWITCH IS IDEAL.
AVAILABLE EITHER NORMALLY
OPEN OR NORMALLY CLOSED.
CONSERVATIVELY RATED AT
 $\frac{1}{2}$ AMP., 115V. A.C.,
NON-INDUCTIVE.

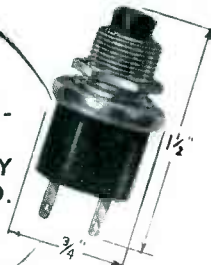

SERIES
4000

THE SERIES 2000 SNAP
ACTION SWITCH IS FOR
HIGHER AMPERAGE CIRCUITS.
OR FOR TEST APPARATUS
WHERE AN AUDIBLE "CLICK" IS
DESIRED AT THE EXACT MO-
MENT OF OPERATION. RATED
AT 10 AMPS., 115V. A.C.,
NON-INDUCTIVE. THE CON-
TACT ARRANGEMENTS
ARE THE SAME AS
THE SERIES 4000.

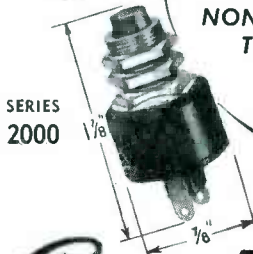

SERIES
2000

GET DETAILS—
Write for the Gray-
hill Catalog now.

Grayhill

4522 West Madison Street

Chicago 24, Illinois

TERMINAL BOARD ASSEMBLIES by 'INDUSTRIAL'

Reduce Costs—Increase Pro-
duction, by specifying IN-
DUSTRIAL Terminal Board
Assemblies. Our large facil-
ities assure you of prompt
deliveries to meet military
production schedules.

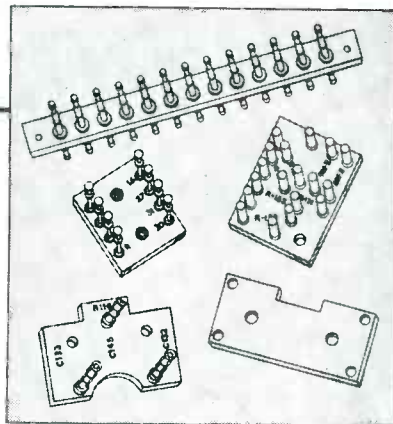

- SOCKETS • TERMINAL STRIPS
- WIRED ASSEMBLIES • BAKELITE STAMPINGS

Consult INDUSTRIAL for all your requirements. Our represen-
tative in your area will be glad to assist you; write or
phone for information and samples.

Phone: ORegon 7-1881



INDUSTRIAL HARDWARE Mfg. Co., Inc.

109 PRINCE STREET • NEW YORK 12, N. Y.

control of electron tubes, and another covers incoming inspection of vendor material.

TELEVISION EQUIPMENT THEORY AND OPERATION. Broadcast Equipment Section, Engineering Products Dept., Radio Corporation of America, Camden, N. J., Sixth Edition, 1951, 444 pages, \$8.00. Manual for television technical training, with four major sections covering Transmitters, Antennas, Video and Audio. Each starts with general principles of design and operation presented much as in handbooks or textbooks, followed by descriptions of available RCA equipment and sections dealing with recommended specific operating procedures.

PROBLEMS FOR THE NUMERICAL ANALYSIS OF THE FUTURE. National Bureau of Standards Applied Mathematics Series 15, 21 pages, 20 cents from Govt. Printing Office, Wash. 25, D. C. Four of papers presented at symposia dedicating NBS Institute for Numerical Analysis on Univ. of Calif. campus; Some Unsolved Problems in Numerical Analysis; Numerical Calculations in Nonlinear Mechanics; Wave Propagation in Hydrodynamics and Electrodynamics; Linear Programming.

ACOUSTICAL TERMINOLOGY. American Standards Association, 70 E. 45th St., New York, 1951, 50 pages, \$1.50. American Standard Z24.1-1951, sponsored by Acoustical Society of America in cooperation with IRE. Revision of 1942 edition.

MATHEMATICS FOR ENGINEERS. By Raymond Dull and Richard Dull. McGraw-Hill Book Co., New York, 1951, Third Edition, 822 pages, \$7.50. Quick reference book for engineers, giving in a single volume a concise yet complete review from algebra through differential and integral calculus.

DESIGN, CONSTRUCTION & OPERATING PRINCIPLES OF ELECTROMAGNETS FOR ATTRACTING COPPER, ALUMINUM AND OTHER NON-FERROUS METALS. By Leonard R. Crow. The Scientific Book Publishing Co., Vincennes, Indiana, 1951, 38 pages, \$1.25. Based on repulsion effect of conductive washer serving as short-circuited secondary of an a-c electromagnet, on use of shading coils and on use of short-circuited copper secondary on center core leg of three-legged a-c electromagnet. Many dramatic arrangements for educational demonstrations are described and pictured.

PRACTICAL ELECTRICITY AND MAGNETISM. By Maurice Rubln. Chemical Publishing Co., New York, 1951, 356 pages, \$7.50. Elementary survey, with emphasis on recent developments. Includes chapters or sections on photoelectric emission, electronics, conductivity of gases, radio, television and radar. The final chapter deals almost entirely with new electronic developments.

ANNUAL REPORT OF THE NATIONAL BUREAU OF STANDARDS FOR 1950. Government Printing Office, Washington, 113 pages, \$50. Summaries of scientific investigations at NBS during 1950 and accounts of current activities. Includes details of the SEAC automatically sequenced electronic computer, NBS electronic currency counter and the omega-tron which discriminates between atomic particles of different masses.

TV AND ELECTRONICS AS A CAREER. By I. Kamen and R. H. Dorf. John F. Rider Publisher, Inc., New York, 1951, 326 pages, \$4.95. A comprehensive book-size answer to the perennial question fired at those in the electronic industry, "How can I get into television or electronics?" After an opening chapter on selecting a career, seven chapters cover the eight major types of careers: Television Broadcasting; A-M F-M Broadcasting and Communications; Radio and Television Manufacturing; Electronic Engineering; Television Servicing; Distribution; Electronics in the Armed Forces.

BACKTALK

Addendum

DEAR SIRs:

ON PAGE 270 of the November 1951 issue of *ELECTRONICS*, the third footnote for Mr. Baruch's article entitled, "Close Differential Thyatron Relay", needs the following information added to it: *AIEE Transactions*, 69, p 270, 1950. This addendum may prove helpful to others who were interested in the article.

GLEN M. DODD

Code 425, Navy Electronics Laboratory
San Diego, California

Wider Range

DEAR SIRs:

AFTER looking over my article "Universal Equalizer Chart" in the November 1951 issue of *ELECTRONICS* (page 132), I was very pleased at how well the charts were reproduced. However, I felt it was unfortunate that the word "audio" crept into the abstract as well as the front contents page. This detracts from the generality of the chart.

As a matter of fact, in the Bell System the bridged-T equalizer is the most abundant type of phase and delay equalizer for video facilities.

D. A. ALSBERG

Bell Telephone Laboratories
Murray Hill, New Jersey

Book Reviews

DEAR SIRs:

I HAVE READ your review of the "Radio Amateur's Handbook" and the "Radio Handbook" which appears in the December 1951 issue of *ELECTRONICS* on page 322. I wish to congratulate you on your objective comments and criticisms of the publications.

Particularly, it is most noteworthy that you have compared the two books in various fields and that you have done this on an "individual merit" basis. This is a far cry from the usual, generally laudatory "Well, boys, here is another edition of X Handbook" reviews which have appeared in the technical press for many years.

Certainly the thoughtful and ob-

ZOPHAR

WAXES

COMPOUNDS

Zophar Waxes, resins and compounds to impregnate, dip, seal, embed, or pot electronic and electrical equipment or components of all types; radio, television, etc.

Cold flows from 100°F. to 285°F.

Special waxes non-cracking at -76°F.

Compounds meeting Government specifications plain or fungus resistant.

Let us help you with your engineering problems.



ZOPHAR MILLS, INC.
112-130 26th Street,
Brooklyn 32, N. Y.

Emergency ELECTRIC POWER

For A.M., F.M., and Television Stations



Model 10 EL
10,000 watts

**ONAN
STANDBY
ELECTRIC
PLANTS**



**PORTABLE A.C. ELECTRIC PLANTS
FOR FIELD AND MOBILE RADIO**

Supply power for transmission at scene of events. Can be carried by hand or in trunk of car. Take up only a few square inches of space in mobile unit. Weigh as little as 80 pounds. Lightweight models: 350 to 3,000 watts. Other models to 35,000 watts.

Stay on the air during power failures. When storms, floods, or breakdowns interrupt electric service to your station and force you off the air, you lose listeners, you lose income. Protect yourself against loss . . . make sure of your ability to give vital service to your community during disaster periods by installing a dependable Onan Emergency Electric Plant.

An Onan plant will take over the job of supplying electricity for studios and transmission automatically when power is interrupted. Plant stops itself when power is restored. Upkeep costs are negligible.

Write for Folder
or Engineering Service



D. W. ONAN & SONS INC.
7026 Univ. Ave., S. E. Minneapolis 14, Minnesota

SELENIUM RECTIFIERS • METER SHUNTS

Introducing

the Model 1028 — a rugged and versatile bench power supply for laboratory and production use

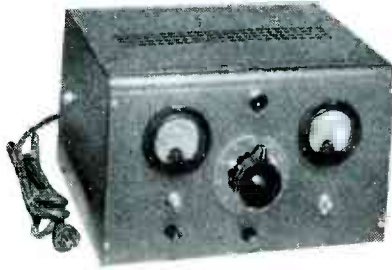

- Continuously variable from 0 to 28 volts D.C.
- 10 amperes continuous duty
- Finest quality components throughout
- Custom built seleniums hand-picked for resistance and voltage characteristics

Send for literature on the Model 1028 and other models to your specifications

INDUSTRIAL RECTIFIER CO.
 120 Cedar Street New York 6, N. Y.
 Phone: D1gby 9-3832

jective review discussed here is one of the finer examples of the reviewers' art. Perhaps it will even stir a policy review in at least one publisher's household.

I must note that I have been finding the book review section of *ELECTRONICS* stimulating. For example, the recent and controversial discussion of the new edition of August Hund's "High Frequency Measurements" (a McGraw-Hill book, too) was most interesting.

J. N. BOLAND
 Raytheon Manufacturing Co.
 Waltham, Massachusetts

Electronics Quiz

LAST month's problem involved a feedback amplifier of the type illustrated in Fig. 1A. The amplifier has an open loop gain of A at an angle of thirty degrees leading and feedback as shown. The problem

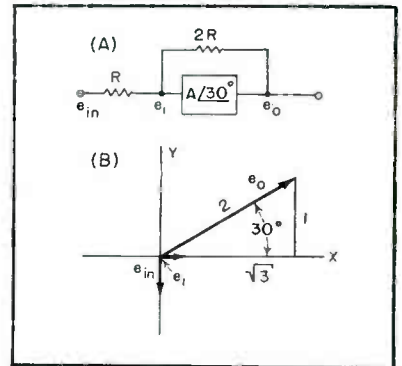

FIG. 1—Illustration of statement and solution of last month's brain teaser

was to determine the maximum value of $|e_o|/|e_{in}|$.

The solution for the problem, as furnished by John J. Antul of the Transducer Corp., is illustrated in Fig. 1B. Since e_{in} has no Y component, e_{in} must have a Y component of $-\frac{1}{2}$ the Y component of e_o . With e_o constant, maximum $|e_o|/|e_{in}|$ occurs when e_{in} is minimum, and then e_{in} has no X component. Therefore

$$\left| \frac{e_o}{e_{in}} \right| = \frac{2}{\frac{1}{2}} = 4$$

Incidentally, it is interesting to note that A is equal to the magnitude of e_o divided by one third the X component of e_o , or $A = 3.464$, and e_o leads e_{in} by 90 deg plus 30 deg, or 120 deg.

GRC CUTS COST AND TIME!



TINY INJECTION MOULDED PRECISION PLASTIC PARTS



INDIVIDUAL PARTS
 No limit on smallness. Intricacy and precision — our unique feature.

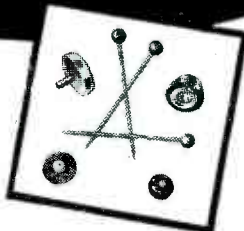

INDIVIDUAL INSERTS
 Automatic insert feed permits wide variety of product possibilities.



CONTINUOUS INSERTS
 Small members accurately spaced on tape, cord, wire, chain, etc.

Completely automatic parts delivered trimmed, ready for use, in one operation, with GRC's speedy, specialized production facilities.
NYLON A SPECIALTY.



Maximum Size: .025 oz.—1 1/4" long. **NO MINIMUM!**

LOW MOLD COSTS
 WRITE TODAY FOR SAMPLES and PRICES



GRIES REPRODUCER CORP.

100 Willow Ave., New York 54 • Phone: MO 5-7400

PROFESSIONAL SERVICES

Consulting—Patents—Design—Development—Measurement

in

Radio, Audio, Industrial Electronic Appliances

CROSBY LABORATORIES, INC.

Murray G. Crosby & Staff
Radio - Electronic Engineering
Research & Development
FM, Communications, TV
Test Equipment

Offices, Laboratory & Model Shop at:
126 Herricks Rd., Mineola, N. Y.
Garden City 7-8812

**WHEN
TIME
IS**

SHORT

put the solution of your problems up to a specialized Consultant whose professional card appears on this page. His broad experience may save you months of costly experimentation.

ELECTRONICS

330 West 42nd St., New York 18, N. Y.

ALBERT PREISMAN

Consulting Engineer
Television, Pulse Techniques, Video
Amplifiers, Phasing Networks,
Industrial Appliances
Affiliated with

MANAGEMENT-TRAINING ASSOCIATES
3308-14th St., N.W. Washington 10, D. C.

DUBROW DEVELOPMENT CO.

Design — Development — Mfr.

Quality Electronic Equipment

347 High St. Burlington, N. J.
Burlington 3-0446

REDEL ENGINEERING

MISSILE GUIDANCE, electronic research, development, and manufacturing.

INFRARED RECEIVERS
MAGNETIC AMPLIFIERS

2309 Riverside Dr., Los Angeles 38, Calif.
NOrmandy 6809

EDGERTON, GERMESHAUSEN & GRIER, INC.

Consulting Engineers

Research, Development and Manufacture
of Electronic and Stroboscopic Equipment
Specialists in High-Speed Photography

160 Brookline Avenue, Boston 15, Mass.

HOGAN LABORATORIES, INC.

John V. L. Hogan, Pres.

Applied Research, Development, Engineering

Est. 1929. Exceptionally competent staff.
Electronics, Optics, Mechanisms, Facsimile
Communication, Electro-sensitive recording
media, Instrumentation.

155 Perry Street, New York 14 CHelsea 2-7855

SKINNER, HARLAN AND IRELAND, INC.

Consulting Engineers

Specializing in Magnetic Materials and
Their Application

Office and Laboratory Indianapolis 7, Indiana

ERCO RADIO LABORATORIES, INC.

Radio Communications Equipment

Engineering - Design - Development - Production
Pioneers in Frequency Shift Telegraph

Garden City • Long Island • New York

MEASUREMENTS CORPORATION

Research & Manufacturing Engineers

Harry W. Houck Jerry B. Minter

John M. van Beuren
Specialists in the Design and
Development of Electronic Test Instruments

Boonton, N. J.

THE TECHNICAL MATERIEL CORPORATION

Communications Consultants

Systems Engineering
General Offices and Laboratory

121 Spencer Place, Mamaroneck, N. Y.

HERMAN LEWIS GORDON

Registered Patent Attorney

Patent Investigations and Opinions

Warner Building, Washington 4, D. C.
NAtional 2497

Eugene Mittelman, E.E., Ph.D.

Consulting Engineer & Physicist

High Frequency Heating—Industrial Electronics
Applied Physics and Mathematics

549 W. Washington Blvd. Chicago 6, Ill.
State 2-8021

TELECHROME, INC.

Electronic Design Specialists

COLOR TELEVISION EQUIPMENT
Flying Spot Scanners, Color Synthesizers, Keyers,
Monitors, Oscilloscopes and Related Apparatus
J. R. Popkin-Curman, Pres. & Ch. Engr.

88 Merrick Rd. Amityville, L. I., N. Y.

HANSON-GORRILL-BRIAN INC.

Products & Mfg. Development

ELECTRICAL - ELECTRONIC
HYDRAULIC - MECHANICAL

One Continental Hill Glen Cove, N. Y.
Glen Cove 4-1922

NIAGARA ELECTRON LABORATORIES

CONSULTATION - DESIGN - CONSTRUCTION
MFG. THE THERMOCAP RELAY

Specializing in solution of problems of electronic
and electro-physical instrumentation for the re-
search or analytical laboratory. Industrial plant
problems also invited.

Andover, New York Cable Address: NIATRONLAB

FREDERICK P. WARRICK

Engineering Consultant

Development & Manufacture of High Speed
Moving Film Cameras for Oscillography &
Stroboscopic Photography

1960 Graefield Road Birmingham, Michigan

R. W. HODGSON

RESEARCH & DEVELOPMENT ENGINEER SPE-
CIALIZING IN ELECTRONICS, NUCLEONICS,
INSTRUMENTATION, SERVOMECHANISMS &
CYBERNETICS

Office—6600 Lexington Ave., Hollywood 38, Calif.
All Mail to Box 874, Sherman Oaks, Calif.
Gladstone 9680

PHYSICAL RESEARCH ASSOCIATES

*Manufacturers of Physical Research Equipment
Management Consultants & Industrial Engineers*
Arthur M. Vigilante, Director

High-gain Television Receiving Arrays, Regulated
Power Supplies, Low Light Level Detection &
Recording Systems for Raman Spectroscopy, Nar-
row Band-width Amplifiers, Dynamic Condenser
Electrometers.

±1 Azurelee Drive Malibu, Calif.

WHEELER LABORATORIES, INC.

Radio and Electronics

Consulting—Research—Development
R-F Circuits—Lines—Antennas

Microwave Components—Test Equipment
Harold A. Wheeler and Engineering Staff

Great Neck, N. Y. Great Neck 2-7806

R. W. HODGSON

PATENT AGENT SPECIALIZING
IN ELECTRONICS

Registered to Practice Before the U. S. &
Foreign Patent Offices

Office—6600 Lexington Ave., Hollywood 38, Calif.
All Mail to Box 874, Sherman Oaks, Calif.
Gladstone 9680

PICKARD AND BURNS, INC.

Consulting Electronic Engineers

Analysis and Evaluation
of Radio Systems

Research, Development and Design
of Special Electronic Equipment

240 Highland Ave., Needham 94, Mass.

YARDNEY LABORATORIES, INC.

Research - Design - Development

Electro-Chemical Generators of Energy

105 Chambers Street WOrth-2-3534, 35, 36
New York 7, N. Y.

• CONTACTS •



COIL PROBLEMS?

Use Allied Control's complete engineering, design and production facilities for electrical coils of all types.

ALLIED CONTROL COMPANY, INC.

2 EAST END AVENUE
NEW YORK 21, N. Y.
Telephone: BUtterfield 8-7403



ELECTRICAL COILS

TO MEET YOUR EXACT REQUIREMENTS and all D. O. & MILITARY SPECIFICATIONS

Any type construction, materials, leads, taps, wire, or finish. For ignition, solenoid, relay, voice, shocks, transformer, clock, motor, switch, television, or communications.

Send your specifications for quotations.



THE FIVE STAR CO.
110 MIXVILLE ROAD
WEST CHESHIRE, CONN.

MICO "SOLDERUX" INSTANT SOLDERING FLUXES

Non-Corrosive. Especially recommended for soft soldering fine wires and small parts of many metals including steel, brass, chromel, constantan, nickel, silver and copper. Mico Solderux Liquid for vigorous action—Mico Solderux Cream for strong action—Mico Solderux Paste for milder action. These fluxes are unique in that chemical action, so necessary in cleaning metals of oxides, grease, and dirt, does not begin until soldering temperatures are reached. When the work cools, any remaining flux subsides into a chemically inert material of low conductivity having non-hygroscopic properties. 1 oz. trial jar—50¢.

MICO INSTRUMENT CO.
76 E Trowbridge St., Cambridge 38, Mass.

RADIO—TV—ELECTRICAL

All-around Trouble Shooter

Will test Radio-TV tubes, ignition coils, condensers (all types), spark-plugs, irons, transformers, speakers, etc., for opens, shorts, leaks, into megohms. Sensitivity compares with V.T.V.M. Tests 70-750 volts AC or DC. Tests mica, paper, oil, ceramic, air and electrolytic condensers for shorts, opens, leaks and you can tell approximate capacity, after few tests.

For All Engineers, experts and beginners. NO DANGER. NO SHOCKS. NO PLUG IN and will not harm anything you test. **\$3.99** plus 25¢ postage 5 day money back guarantee.

HOWARD SALES CO., 539 Atlantic Avenue
Brooklyn 17 New York Dept. E



FOR MAINTENANCE OF MOBILE COMMUNICATIONS SYSTEMS
MICROMETER FREQUENCY METER FM MODULATION METER
LAMPKIN LABORATORIES, INC.
Bradenton, Florida

SUB-CONTRACTING MILITARY and COMMERCIAL receivers—test equipment transmitters—controls sub-assemblies
TELETRONICS LABORATORY, INC.
Westbury, L. I., N. Y. Westbury 7-1028



EL-TRONICS, INC.

Research—Development—Manufacture
A single unit to large production quantities. Specialists in Nuclear Instruments, Test Equipment and Instrumentation
Send for Free Resume of our Facilities
2657 N. Howard St. Phila. 33, Pa.
GARfield 5-2026

Shorted Turn Indicator for unmounted coils
MODEL 101C BULLETIN 42
HUNTINGTON BEACH, CALIF.

KARTRON

WALKIE-RECORDALL 3 lb. miniature BATTERY RECORDER-PLAYBACK

Continuous, permanent, indexed recording, up to 4 hrs., only 3c hr. Instantaneous, permanent playback. Picks up sound up to 60 ft. Records conferences, lectures, dictation, 2-way phone & sales talks; while walking, riding or flying. Records in closed briefcase with "hidden mike"! Write for Detailed Literature.

MILES REPRODUCER CO., INC.
812 BROADWAY Dept E-2 NEW YORK 3, N. Y.

MAKE MORE PROFIT BY RE-PROCESSING BURNED OUT AND OUT OF WARRANTY TELEVISION PICTURE TUBES IN YOUR OWN SHOP.

Specially designed low cost equipment for small business, for reprocessing tubes in quantities of 10 to 25 tubes per day. Complete engineering data included. Free instruction course with each unit. Terms can be arranged. Write for detailed information to

Box 80-2899, Electronics
330 W. 42 St., New York 36, N. Y.

This CONTACTS Section

supplements other advertising in this issue with these additional announcements of products essential to efficient and economical production and maintenance. Make a habit of checking this page, each issue.

NOW

a really high-powered

RADIO ENGINEERING LIBRARY



Special Offer on This Complete Up-to-Date Set

Save \$4.00! These fine engineering books would cost a total of \$40.50 at our regular single-copy prices, if you bought them one or two at a time. Under this offer you can have the whole set at once and we'll pass along the saving in handling in a special low Library of only \$36.50. In addition you may spread this over several installment payments as shown in the coupon below. Take advantage of these convenient terms to add these helpful books to your working library right away.

5 volumes, 3,921 pages,
2,770 illustrations

Eastman's FUNDAMENTALS OF VACUUM TUBES, 3rd Ed.
Terman's RADIO ENGINEERING, 3rd Ed.
Everitt's COMMUNICATION ENGINEERING, 2nd Ed.
Hund's HIGH-FREQUENCY MEASUREMENTS, 2nd Ed.
Henney's RADIO ENGINEERING HANDBOOK, 4th Ed.

What this library gives you

These books cover circuit phenomena, tube theory, networks, measurements, and other subjects—give specialized treatments of all fields of practical design and application. They are books of recognized position in the literature—books you will refer to and be referred to often. If you are a practical designer, researcher, or engineer in any field based on radio, you need these books for the help they give in hundreds of problems throughout the whole field of radio engineering.

10 DAYS' FREE EXAMINATION

McGraw-Hill Book Co., 330 W. 42nd St., N.Y.C. 18
Send me RADIO ENGINEERING LIBRARY for 10 days' examination on approval. In 10 days I will send \$6.50, plus few cents for delivery, and \$6.00 monthly until \$36.50 is paid, or return books postpaid. (We pay delivery if first payment accompanies this coupon; same return privilege.)

(Print)
Name
Address
City Zone State
Company
Position
(This offer applies to U.S. only) **PL-8-58**

EISLER Manufactures Complete Equipment for:

SPOT WELDERS, Electric, for 1/4 to 250 KVA.
TELEVISION TUBE GLASS WORKING EQUIPMENT.
TRANSFORMERS, Special and Standard Types.
INCANDESCENT LAMP Manufacturing Equipment.
FLUORESCENT TUBE Manufacturing Equipment.
NEON SIGN MAKERS EQUIPMENT.
ELECTRONIC EQUIPMENT, Vacuum Pumps, etc.
WET GLASS SLICING and Cutting machines for Laboratory use.
EISLER ENGINEERING CO., Inc 751 So 13th St. Newark 3, N. J.

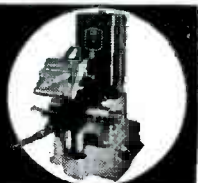

SEARCHLIGHT SECTION

(Classified Advertising)

EMPLOYMENT • BUSINESS
EQUIPMENT — USED OR RESALE
OPPORTUNITIES

UNDISPLAYED: \$1.50 per line, minimum 3 lines. Count 5 average words as one line. **POSITION** or **SELLING OPPORTUNITY WANTED** are ½ these rates, payable in advance.

BOX NUMBERS care of this publication count as one additional line.

DISPLAYED: \$14.00 per column inch per insertion. Contract rates are quoted on request. The advertising inch is 7/8" deep by 2 1/4" wide. There are 10 inches to one column, 30 inches to the page.

NEW ADVERTISEMENTS received by Feb. 1 at the New York office, 330 W 42nd St. N. Y. 36, will appear in the March issue, subject to limitation of space available.

SALES ENGINEER

to organize and direct sales department
COIL WINDING MACHINERY

Excellent opportunity for man who understands coil winding machines and can sell a line unsurpassed in quality. Must have thorough experience all phases coil winding equipment and end products. Our organization knows of this advertisement. Replies in strict confidence.

Write Box P-3006, Electronics
330 W. 42nd Street, New York 36, N. Y.

REPLIES (Box No.): Address to office nearest you
NEW YORK: 330 W. 42nd St. (38)
CHICAGO: 520 N. Michigan Ave. (11)
SAN FRANCISCO: 63 Post St. (4)

EMPLOYMENT SERVICE

SALARIED PERSONNEL, \$3,000-\$25,000. This confidential service established 1920, is geared to needs of high grade men who seek a change of connection under conditions assuring, if employed, full protection to present position. Send name and address only for details. Personal consultation invited. Jira Thayer Jennings, Dept. L, 241 Orange St., New Haven, Conn.

SELLING OPPORTUNITIES WANTED

AN OLD American machine sales establishment is looking for new connections and would like to represent American manufacturers in the United States and foreign countries, not necessarily on an exclusive basis. We are interested in handling machine tools and electrical appliances. We have offices and warehouses in New Jersey. Reply to RA-2915, Electronics.

ELECTRICAL COMPONENTS Representative covering N. Y. City, L. I. and Northern N. J. desires additional line. Ten years experience, excellent contacts with mfrs. RA-2970, Electronics.

PATENTS

Consult A. John Michel.
Registered Patent Att. specializing in Electronics. 15 Park Row, New York 38, N. Y. Tel. CO-7-9034.

CONSULT: Z. H. POLACHEK.
Reg. Patent Attorney, 1234 Broadway, New York 1, N. Y.

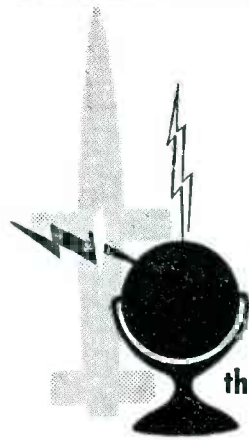

ENGINEERS

Special opportunities for YOU in

SAN DIEGO

that sunshiny, smog-free city on the

coast of CALIFORNIA

Convair (Consolidated Vultee Aircraft Corporation) is now accepting applications for these following positions in its modern, progressive Engineering Department.



Microwave Engineers
Servomechanism Engineers
Electronics System Engineers
Electronic Circuit Designers

Unusual opportunities for those experienced in the design and analysis of Radar and Missile Guidance Systems.



WORKING FACTS: You get two holidays a week at Convair — overtime accomplished in 5-day week. Attractive salary ranges. An "engineers" engineering department... with stimulating, competent associates... and interesting, challenging, essential, long-range projects of a wide variety including — commercial aircraft, military aircraft, missiles, engineering research and electronic development. Excellent patent royalty arrangements. Top-notch retirement plan — better than-average life and health insurance. Complete progress-salary review for each person twice yearly. Opportunity for continuing engineering education.

LIVING FACTS: San Diego, with its wonderful residential areas, offers you and your family incomparable living. Ideal climate — cool, clean, dry. Mountains, desert, Mexico, Hollywood, Los Angeles, Pacific Ocean, beaches and bay — only hours or minutes away. It offers you a new way of life... pleasant, refreshing, happy.

If you qualify, you will receive generous travel allowances.
SEND COUPON for free booklets and complete information.

THANK YOU

Mr. H. T. Brooks, Engineering Department 900

Convair, 3302 Pacific Hiway, San Diego, California

Please send me **FREE** booklets describing the Convair Opportunity for me and my Convair Application Form.

My name _____

Occupation _____

Address _____

City _____ State _____

engineers...
 physicists...
 chemists...
 metallurgists...

GENERAL ELECTRIC

Can Mean A Turning Point in Your Career

In terms of personal satisfaction, assured professional advancement, diversification, and prestige, you can give new impetus to your career through these positions now open with General Electric in: Advanced Development, Design, Field Service, and Technical Writing, in connection with:

- MILITARY RADIO & RADAR
- MOBILE COMMUNICATION
- MULTIPLEX MICROWAVE COMMUNICATIONS
- ELECTRONIC COMPONENTS
- TELEVISION, TUBES and ANTENNAS

Bachelor's or Advanced Degree in Electrical or Mechanical Engineering, Physics, Metallurgy or Physical Chemistry and/or experience in the Electronics industry necessary.

Please send resume to:

DEPT. 22A, TECHNICAL PERSONNEL
 ELECTRONICS PARK

GENERAL ELECTRIC
 SYRACUSE, N. Y.

ELECTRONIC ENGINEERS

Degree in Electrical Engineering
 Plus Maintenance or Repair Experience on SCR-584 Radar

**ELECTRONIC ENGINEERING COMPANY
 OF CALIFORNIA**

180 SO. ALVARADO STREET
 LOS ANGELES, CALIFORNIA

LABORATORY INSTRUMENTATION MAN

Responsible position for Instrumentation man, preferably a chemical engineer with strong leaning toward Instrumentation involving maintenance, design, and selection of electronic and other Instruments required by chemical research groups. Position requires a more practical than theoretical man having good gadgeteering sense. Practical knowledge of high and low voltage electrical circuits is desirable. Location Anniston, Alabama.

Please state qualifications and salary requirements in letter addressed to: R. F. McCoolle, Technical Personnel Manager,

MONSANTO CHEMICAL COMPANY
 ST. LOUIS 4, MISSOURI

Caphart

needs outstanding

- RESEARCH PHYSICISTS
- SR. ELECTRONIC ENGINEERS
- SR. MECHANICAL ENGINEERS
- ENGINEERING PHYSICISTS
- CIRCUIT ENGINEERS
- MICROWAVE ENGINEERS
- TELEVISION ENGINEERS
- VACUUM TUBE ENGINEERS
- TEST EQUIPMENT ENGINEERS
- FIELD ENGINEERS
- ELECTRONIC TECHNICIANS

with advanced academic training
 and several years' experience
 for

RESEARCH AND DEVELOPMENT

in Radar, Servos, Computers, Receivers, Solid State Physics, Image Converters, Pulse and Timing Techniques, Special Purpose Tubes, Networks and Systems Design, Light and Electron Optics, Storage-Type Tubes, Photo-Electric Pickup Tubes, and Related Test Equipment.

Our Long Range Programs and Steady Growth Assure Permanent Employment at Excellent Salaries for Competent and Qualified Personnel.

Interested Persons are Invited to Submit Detailed Resumes of Experience and Education with Salary Requirements and Availability Date to:

The Employment Department

CAPEHART-FARNSWORTH CORPORATION

FORT WAYNE, INDIANA

ATOMIC WEAPONS INSTALLATION NEEDS ELECTRONIC ENGINEERS

Two to ten years' experience in research, design, development or test. Patent history desirable but not necessary. A variety of positions open for men with Bachelor's or advanced degree qualified in one or more of the following fields:

- RELAYS
- TELEMETERING
- PULSE CIRCUITS
- UHF TECHNIQUES
- SERVO-MECHANISMS
- INSTRUMENTATION
- QUALITY CONTROL
- LOW POWER APPLICATION
- TEST EQUIPMENT RELATING TO ABOVE FIELDS

TECHNICAL WRITERS

Experienced in preparation & publication of standards, electronic & mechanical technical manuals. Engineering background necessary.

JOB ANALYSTS

Mechanical & electrical engineers experienced in job evaluation & other wage administration activities.

PHYSICISTS

With pure physics background.

STANDARDS ENGINEERS

Experienced in writing specifications, in liaison work, and in correlating design information to accepted standards. Aircraft industry experience desirable.

These are PERMANENT POSITIONS with Sandia Corporation in Albuquerque, New Mexico. The Laboratory is operated by Sandia Corporation, a subsidiary of Western Electric Company, under contract with the ATOMIC ENERGY COMMISSION. This laboratory offers good working conditions and liberal employee benefits, including paid vacations, sick leave, and a retirement plan.

Albuquerque, center of a metropolitan area of 150,000, is located in the Rio Grande Valley, one mile above sea level. The "Heart of the Land of Enchantment." Albuquerque lies at the foot of the Sandia Mountains, which rise to 11,000 feet. Climate is sunny, mild and dry the year 'round. No housing shortage in Albuquerque.

MAKE APPLICATION TO
Professional Employment
SANDIA CORPORATION
SANDIA BASE
ALBUQUERQUE, N. M.

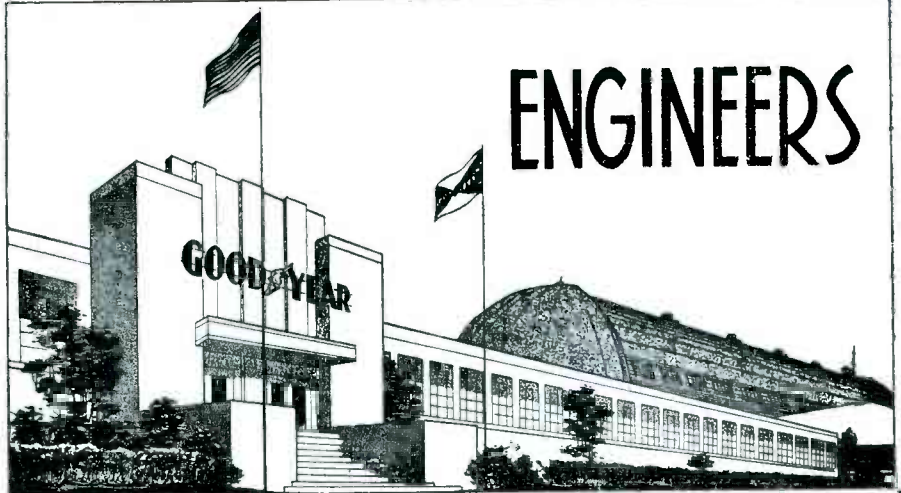

ENGINEERS

ENGINEERING WITH A FUTURE

RESEARCH • DEVELOPMENT • DESIGN

The continued and steady growth of established research and development projects has opened a number of unusual opportunities for outstanding and experienced men.

ENGINEERS • SCIENTISTS • PHYSICISTS

Positions are available in our organization for qualified personnel in the following fields:

Circuit Analysis
Microwaves
Analog Computers
Servomechanisms
Dynamics

Aerodynamics
Applied Mathematics
Physics
Flight Test
Design

Openings exist at several levels, and inquiries from recent graduates are also invited. Salaries are based on education, ability, and experience. Liberal salary, vacation, insurance, and retirement plans are yours if you qualify.

If you are interested in a secure future in these experimental fields, write and give full details to Mr. C. G. Jones, Salary Personnel Department.



Akron 15, Ohio

Large Electronic Manufacturer located in Boston
area has immediate openings for

MECHANICAL BUYER

Man with experience in procurement of large and small machined components to tight machine tolerances. Machine shop experience valuable consideration in selection of applicant. Past experience in electronic or allied industry preferred. Ability to evaluate prints for methods and cost estimating is important. Please write giving full particulars.

SHEET METAL BUYERS

Man with experience in procurement of sheet metal components (chassis—cases—panels, etc.) Applicants should have thorough knowledge of equipment, methods and cost estimating of both ferrous and non-ferrous sheet metal fabrication and welding. Past experience in buying similar components under tight quality control regulations desired. Please write giving full particulars.

P-2874, Electronics
330 W. 42nd St., New York 18, New York

**MAKE THIS YOUR HOME
FOR IMPORTANT WORK
UNDER IDEAL CONDITIONS**



- TV RECEIVER DESIGN ENGINEERS
- ELECTRONICS ENGINEERS
- FIELD ENGINEERS
- TEST & INSPECTION ENGINEERS
- LAB. TECHNICIANS

NEEDED TO WORK ON: Radar, G.C.A., Mobile Radio, Auto Radio, Airborne Communication & Navigation Equipment, Television, Antennas, Microwave Equipment, Servo Mechanisms and Guided Missiles.

YOU BENEFIT AT BENDIX RADIO: from high wages, a modern, air-conditioned plant, paid vacations and holidays, group insurance and a good chance for advancement.

Housing immediately available in the beautiful suburban and country areas that surround the Bendix Radio plant.

Write, Wire or phone
MR. E. O. COLE, DEPT. J. **Bendix Radio**

DIVISION OF BENDIX AVIATION CORPORATION
BALTIMORE-4, MD. Phone: TOWSON 2200

*Makers of the World's Finest
Electronic Equipment*

ENGINEERS
Electronic & Electro-Mechanical
and **DESIGNERS**

*Make Your Move
In the
Right
Direction*



**POSITIONS
THAT POINT
TO A
SUCCESSFUL
FUTURE!**

**Minimum
Requirements
for
ENGINEERS**

Four years' experience in advanced research and development on Radar Systems, Computers, Wave Guide and Antennas, Fire Control, Moving Target Indication, Servo-mechanisms, Pulse Techniques, Gyroscopic Equipment and Fields.

**Minimum
Requirements
for
DESIGN
ENGINEERS**

Background-Experience in design of Light Machinery, Radar Systems, Computers, Moving Target Indicators, Servo-mechanisms, Gyroscopic Equipment and Related Fields.

If your skills are now being fully utilized in a vital defense industry, please do not apply.

Kindly send resume and salary requirements to:

The **W.L. MAXSON
CORPORATION**

460 W. 34th St. New York 1, N. Y.

**Development
Engineers**

**With Several Years Design Experience
or Advanced Degrees
for Permanent Positions with**



Endicott, N. Y. Poughkeepsie, N. Y.

**Fields of Electronics, Circuitry,
Mechanisms and Micro-Waves**

Excellent working and living conditions, good salaries, exceptional employee benefits.

Write, giving full details, including education and experience to: Mr. R. H. Austin, Personnel Director, International Business Machines, 1723 North Street, Endicott, N. Y.

INTERVIEWS ARRANGED IN YOUR CITY



Wanted

**ENGINEERS
AND
SCIENTISTS**

Unusual opportunities for outstanding and experienced men.

These top positions involve preliminary and production design in advanced military aircraft and special weapons, including guided missiles.

Immediate positions include:

- Weight-control engineers
- Electronic project engineers
- Electronic instrumentation engineers
- Radar engineers
- Flight test engineers
- Stress engineers
- Aero- and thermodynamicists
- Servo-mechanists
- Power plant installation designers
- Structural designers
- Electro-mechanical designers
- Electrical installation designers

*Excellent location in Southern California.
Generous allowance for travel expenses.*

Write today for complete information on these essential, long-term positions. Please include resume of your experience & training. Address inquiry to Director of Engineering.

NORTHROP AIRCRAFT, INC.

1009 E. Broadway

Hawthorne (Los Angeles County) California

*Want a
Better Job?*

ELECTRONIC

ENGINEERS & TECHNICIANS

investigate

HASTINGS INSTRUMENT CO.

HAMPTON, VIRGINIA

Designers • Manufacturers

of

- ☆ **Raydist** — Most precise of all radio positioning and tracking systems for land, marine and aviation work — accurate to 1 foot in a mile.
- ☆ **PRECISION** — Velocity, pressure, flow and vacuum measuring and recording equipment.



• Hastings offers interesting opportunities for engineering and technical personnel in a long term development and production program — Excellent salary — Pleasant working and living conditions — Ideal climate — Investigate this aggressive, medium sized, pioneering, company today — Work with a select group of exceptionally qualified young men. Your inquiry will receive prompt reply.

WORK FOR A GROWING COMPANY IN THE HEART OF VIRGINIA'S FAMOUS RESORT AREA



Write Today

HASTINGS INSTRUMENT COMPANY, INC.



HAMPTON 21, VIRGINIA

Engineers

choose your area
of specialization at
Minneapolis-Honeywell

Minneapolis-Honeywell Regulator Company, the leader in the field of automatic controls and instrumentation, is presently engaged in research and design work in the areas listed below in both the aeronautical and general engineering divisions. Much of this work borders closely on so-called "pure" or "basic" research.

If you as an engineer are primarily concerned with any of these fields of work; if you have the proper background; and if you are interested in becoming associated with a stable progressive firm, please let us hear from you.

- electronics
- servo-mechanisms
- hydraulics
- electro-magnetics
- heat transfer
- vacuum tubes
- gyros
- relays
- computers
- electro-mechanical devices
- semi-conductors
- bearings
- electrical contact phenomena

Excellent opportunities for advancement in an expanding organization. Promotions granted on basis of merit. Salaries commensurate with background. Address reply to:

R. WAGNER

Minneapolis-Honeywell Regulator
Company

2753 Fourth Avenue South
Minneapolis, Minnesota

MINNEAPOLIS
Honeywell



First in Controls

*California
Calling*

AIRCRAFT ELECTRICAL and RADIO DESIGNERS

A better job, a better life, a better future can be yours in California—at Lockheed Aircraft Corporation.

On the job, you enjoy increased pay; fine, modern working conditions; association with top men in your profession—men who have helped build Lockheed's reputation for leadership.

Off the job, you live in a climate beyond compare—where outdoor living can be enjoyed the year around.

In addition, Lockheed's production rate and backlog of orders—for commercial as well as military aircraft insures your future.

REQUIREMENTS:

Design experience in aircraft electrical installation, circuit layout and systems analysis; experience in radio and radar circuit design and installations, as applied to aircraft.

NOTE TO ENGINEERS WITH FAMILIES:

Housing conditions are excellent in the Los Angeles area. More than 35,000 rental units are available. Thousands of homes have been built since the war; huge tracts are under construction now. You will find the school systems as good—from kindergarten to college.

Send today for free, illustrated brochure describing life and work at Lockheed in Southern California. Use handy coupon below.

Mr. M. V. Mattson, Employment Manager Dept. EL-1

LOCKHEED

AIRCRAFT CORPORATION, Burbank, California

Dear Sir: Please send me your brochure describing life and work at Lockheed.

My name _____

My address _____

My city and state _____

My occupation (type of engineer) _____

ELECTRONIC ENGINEERS



Wide range of experience including design of wide band receivers, radar display systems, analogue computers, servo systems & CR oscillographs . . . thorough knowledge of RF circuits, wave shaping, pulse forming, triggers & gates (microwave techniques unnecessary)

A FEW KEY POSITIONS . . .

Opening of our own manufacturing facilities creates permanent positions in research and development of vital, long-range products.

CONSIDER THESE ADVANTAGES . . .

- . . . Gracious country living, free from big-city pressures, provides a relaxing atmosphere in which you can do your best work . . . yet within easy reach of the cultural advantages of New York City.
- . . . Association with an established yet growing organization with few competitors in the field, where your merit and ability are given full consideration.
- . . . Unusual company-paid benefits . . . 40-hour week with considerable premium overtime . . . moving expenses paid.

TAKE ADVANTAGE OF THIS OPPORTUNITY NOW!

Address all inquiries to J. H. McCann

SPERRY PRODUCTS INC.

DANBURY
CONNECTICUT

CORNELL AERONAUTICAL LABORATORY, INC.

an affiliate of Cornell University

employs about 700 people on vital research work in all branches of aeronautical science. We are gradually expanding our scientific staff, and have several permanent positions open for:

- ELECTRONICS ENGINEERS
- PHYSICISTS
- MECHANICAL ENGINEERS
- AERODYNAMICISTS
- AERONAUTICAL ENGINEERS
- CHEMICAL ENGINEERS

in such fields as:

- GUIDED MISSILES
- RADAR RESEARCH
- BASIC AND APPLIED PHYSICS
- ELECTRONIC COMPUTERS
- SYSTEMS ANALYSIS
- AIRCRAFT PRECISION INSTRUMENTATION
- WIND TUNNEL RESEARCH
- FLIGHT RESEARCH
- DEVELOPMENT ENGINEERING
- HEAT TRANSFER
- THERMODYNAMICS

Minimum requirement is a B.S. Advanced degrees are even better, but experience to back up the degree is really best. We pay industrial salaries. Other tangible advantages here (for example, our self-sponsored internal research policy) should be of particular interest to men with intelligence, ingenuity, and initiative. Send us your resume; all inquiries are strictly confidential. Promising candidates will be invited to Buffalo for interviews at Laboratory expense.

CORNELL AERONAUTICAL LABORATORY, INC.

P. O. Box 235 Buffalo 21, New York

LOOKING AHEAD?

If you're a top performer in the field of physics, electronic engineering or design, and you're looking for a career as well as a well-paid position, it will pay you to investigate the excellent opportunity we offer.

.

BASIC QUALIFICATIONS: Minimum of four year's experience in advanced research or development related to:

- PULSE CIRCUITS
- COMPUTERS
- NUCLEAR INSTRUMENTS
- MINIATURIZATION

.

ILLUSTRATED BROCHURE on request. Please write (giving summary of your education and experience, plus salary requirements) to:

THE BERKELEY SCIENTIFIC CORP.
2200 Wright Avenue
RICHMOND, CALIFORNIA



AC SPARK PLUG DIVISION

of
GENERAL MOTORS CORPORATION

PRECISION INSTRUMENT PLANT

Positions now available for highest caliber personnel in the field of airborne automatic electro-mechanical control equipment.

MECHANICAL DESIGN ENGINEERS
ELECTRONIC ENGINEERS
SERVO ENGINEERS
ELECTRONIC DESIGNERS
MECHANICAL DESIGNERS

New and expanding division of an established firm with 20 years of successful experience in the instrument field. Work involved deals with the manufacture and development of highly complex equipment of the most advanced type.

Write or Apply

AC Spark Plug Division
GENERAL MOTORS CORPORATION
1925 E. Kenilworth Place
Milwaukee 2, Wisconsin

EMPLOYMENT . . . EQUIPMENT . . .
BUSINESS

OPPORTUNITIES

*Whatever your need—
think "SEARCHLIGHT" FIRST*

ELECTRONIC ENGINEERS

Seniors and Juniors

- Outstanding opportunities for engineers with background in one or more of the following fields:
- Wide Band Video and Low Power Pulse Circuitry, Including Amplifiers, Oscillators, Modulators
- Wide Band FM Circuits
- Microwave Techniques, Incl. Antenna Design, RF, Plumbing and Tubes, Such as Traveling Wave, Klystron, Magnetron

Experience should include design, analysis, and development in above fields.

To work with internationally known scientists in well equipped Manhattan laboratories of leading electronic concern on fundamental research and development problems. Our staff advised of this ad.

Top compensation for qualified men.

- Write full details including salary required to

Box P-2893, Electronics
330 W. 42nd Street, New York 36, N. Y.

ELECTRONIC ENGINEERS

Permanent expansion program offers fine career opportunities with one of the leading companies in the industry.

Tung-Sol Electric Inc. Radio and Television tube manufacturers, is now interviewing qualified engineers for immediate job openings at excellent salaries with fine opportunities for advancement.

Experienced Engineers—If you have had experience in any phase of radio tube manufacturing including design, development, production, application or special problems involving glass technology, shrinkage control, etc., we would like to hear from you.

Trainees—We also have a limited number of openings in our training program for those men who hold a degree in electronics but have no experience in this field.

Write or apply in person to

Personnel Director

TUNG-SOL ELECTRIC INC.

200 Bloomfield Ave.,
Bloomfield, N. J.



ATTENTION!

Former Field Engineers

We urgently need men with electronic background, and preferably radar or computer experience, to supervise, instruct and assist in installation—maintenance of electronic equipment.

Excellent starting salary during factory training, plus overtime premium in field. Substantial insurance program. Overseas duty not mandatory. Salary will be commensurate with experience.

Please forward your personal experience record to:

Personnel Supervisor
Field Eng. Div.

Reeves Instrument Corp.
215 East 91st St.
New York, 28, N. Y.

ENGINEERS WANTED

Motorola Research Laboratory PHOENIX, ARIZONA

Permanent positions available in ideal healthful climate. Only fully qualified project leaders and development engineers should apply. Microwave, measurement communications, pulse technique, and antenna specialists needed. Exceptional opportunity for qualified microwave radar project leader and microwave antenna specialists.

First confidential letter should include summary of education, experience and past salary schedules. Similar positions open in MOTOROLA Chicago laboratories.

WRITE

Daniel E. Noble

Communications & Electronics Div.,

MOTOROLA, INC.

4545 Augusta Blvd.

Chicago 51, Illinois

MECHANICAL ENGINEER

SENIOR
FOR SYLVANIA'S
LONG ISLAND RESEARCH
& DEVELOPMENT LABORATORIES

To work on mechanical design and development of vacuum tubes, electronic devices, experimental tools, dies, and laboratory equipment.

BS in ME and minimum of 5 years experience in electro-mechanical field essential.

Please send complete resume to:

MANAGER OF PERSONNEL
DEPT. ME-1

SYLVANIA

Electric Products, Inc.
40-22 Lawrence St.
Flushing, N. Y.

TOP EXECUTIVE

Manufacturer of Capacitors

Top executive position in existing electronics capacitor manufacturing company located in California available for right kind of man who can take over complete management and run sales and engineering department. Salary and other terms open for negotiation. Please write giving all details as to present and former employers, references and background. Replies held confidential. Address: Box No.

P-2977, Electronics
380 W. 42nd St., New York 36, New York

ENGINEERS and PHYSICISTS

Work in Challenging Design and Development Fields Combining the Benefits of Essential Work with Security and Rapid Professional Advancement. Enjoy, among other Benefits:

- Overtime (5-day week)
- Company-Paid Insurance
- Periodic Merit Reviews
- Excellent Compensation

IMMEDIATE OPENINGS EXIST FOR MEN EXPERIENCED IN THE FIELDS OF

- GYROSCOPICS
- ANALOG COMPUTERS
- FIRE CONTROL SYSTEMS
- SERVO MECHANISMS
- INSTRUMENT DESIGN
- CONTROL CIRCUITS

Reply by sending complete resume to
TECHNICAL PERSONNEL OFFICE

ARMA CORP.

254 36th St. Brooklyn 32, N. Y.

CHICAGO MIDWAY LABORATORIES

Long Range Research
on the
UNIVERSITY OF CHICAGO
CAMPUS

Qualified research men are needed in the fields of:

INFRA RED	TEST EQUIPMENT
MICROWAVES	MACHINE DESIGN
BALLISTICS	INSTRUMENT DESIGN
ELECTRONICS	SERVO MECHANISMS
OPTICS	TELEMETERING
SOLID STATE	

This laboratory is undertaking fundamental and applied research on the problems of tactical air warfare. You will work with top level research men as well as many senior scientists of the University of Chicago.

Qualified men will enjoy rapid advancement in this stimulating academic atmosphere. Recent engineering and science graduates will gain valuable experience with which to start a research career. The salary scale is that generally prevailing in industry, with generous vacation allowance and benefits.

Since the laboratory is being established at the request of the air force, the high priority of the work involved should furnish a favorable basis for draft deferments. Applicants must be U.S. citizens.

Address your inquiries to:

CHICAGO MIDWAY LABORATORIES

The University of Chicago
Watts S. Humphrey
Director of Scientific Personnel
6040 South Greenwood Avenue
Chicago, Illinois

POSITIONS OPEN

Location
KANSAS CITY, MO.

Electronic & Mechanical Engineers

ELECTRONIC ENGINEERS: Must have considerable development experience in radio transmitting and receiving equipment. Ability to fill position of Senior Project Engineer a requisite.

MECHANICAL ENGINEER: Must have development experience in mechanical design of electronic or similar precise equipment. Practical and theoretical knowledge of materials, finishes, sheet metal, and machine shop design are basic requirements. Position is one of considerable responsibility.

SALARY: Open.

These positions are permanent. Write stating educational and professional history direct to:

Jay V. Wilcox, President
WILCOX ELECTRIC COMPANY, INC.
1400 Chestnut St. Kansas City 1, Mo.
Dependable communications since 1931

ENGINEERS WANTED

PERPLEXED?

The keystone of our long range program is a carefully planned seminar devoted to advanced study and management participation which, after an introductory period, you will be invited to join. Your ideas and opinions on technical, managerial, and personnel problems will be welcomed and used.

Positions in Antenna Research and Development for Senior and Junior Engineers, Physicists and Mathematicians. Liberal patent and other benefits. Send resume to Arthur Dorne.

DORNE AND MARGOLIN
Sheridan Ave., Bethpage, N. Y.

CHECK CIRCLE FOR VALUES!

STANCOR TRANSFORMERS
T-101—Pri. Z. 75 ohms, Sec. Z. 125,000 ohms, Turns Ratio 1-41, 920 watts, Pri. D.C. Res. 5.50 ohms, Sec. D.C. Res. 2620 ohms, Freq. Resp. 200-5000 **BRAND NEW \$2.45**
T-102—Pri. Z. 6000, Sec. Z. 6000, Turns Ratio 1-1, 20 watts, D.C. Res. Pri. 170, D.C. Res. Sec. 215, Freq. Resp. 200-5000, Test 3000 V. **BRAND NEW \$2.95**
T-201—Pri. Z. 7500, Sec. Z. 600, Turns Ratio 3.85-1, D.C. Res. Pri. 560 Sec. 42, Freq. Resp. 200-5000, Test Volts—1500. **BRAND NEW \$2.75**

DYNAMOTORS
D-104—Dual 12 V. input, output 225 and 440 V. **BRAND NEW \$19.00**
Type PS-225—28 V. input, 375 output @ 1.50 amps. \$4.95
PE-94—Used, good \$2.95

CONTROL BOXES
C-237/APG15, Brand New \$8.95 ea.
C-141/APG15, New \$9.95 ea.

ANTENNA ASSY AS-69AMP, Brand New \$5.95
ARC-5 PLUGS 59¢ ea.
CANNON PLUGS—AP-4-14 or AP-6-14, New 39¢ ea.

WESTERN ELECTRIC VOLTAGE REGULATOR
BC-937 B, used, excellent \$7.75 ea.

SURPLUS WANTED! !
ELECTRONICS*
* Telephone & Teletype Equipment
WE PAY TOP DOLLARS! ANY QUANTITY!

TERMS—Send 25% deposit with order, balance C.O.D. Shipped F.O.B., N.Y.C. (N.Y.C. residents add 3% sales tax.)

CIRCLE SALES CORP.
113 GREEN ST., N.Y. 12, N.Y. - WOrth 4-1541-2

Priced Right—Immediate Delivery

E
X
A
M
P
L
E

**100,000 RELAYS
50 TYPES**

Six-Pole Double Throw Allied # BN-18D-39 has 10 AMPERE CONTACTS 2800 ohm coil operates on 30 millis DC. \$6.95
Struthers-Dunn 115v. AC Coil Mitelex Base & Cross-arm D.P.D.T. 1/4" contacts conservatively rated 6 amp. @ 500v. r. \$3.95
Guardian #150-A—Double Pole Double Throw 8 Ampere Contacts. 115V. A.C. Coll. Single screw mounting \$2.50
Advance Series 1000 115v. AC. Coll 1/4" silver D.P.D.T. cts. Ceramio insulation \$3.95
Advance Series 2000 115v. DC Coil 4200 ohms. All Other Specs as above \$3.95
Potter & Brumfield #MR7D—Double Pole N.O. 10 ampere contacts. 6000 ohm coil operates on 110V. D.C. \$1.95
Potter & Brumfield #MRA—Double Pole N.O. 10 ampere contacts. Coil operates on 6V. A.C. \$1.95
Leach Relay #1024-A 3 Pole N.O. 100 ohm coil operates on 6v. DC. \$1.95
G.E. Relay #CR 2791-B109P36—S.P.D.T. double break contacts rated 3 amps. 10,000 ohm coil operates on 8 millis DC. \$1.95
Allied #BO 635 D.P.D.T. 15 amp. cts. 24v. dc 230 ohm coil \$2.50

RADIO DEVELOPMENT & SALES CO.
323 Atlantic Ave., Brooklyn 2, N. Y. ULster 5-0488

COIL WINDING EQUIPMENT FOR SALE

RF—IF—TV Coil Manufacturers who are interested in Universal and Stevens Winders, Production TEST Equipment, LABORATORY Equipment and many items of WIRE, CORES, ETC., may obtain complete list and arrange for inspection on premises of former Coil Manufacturer. Address inquiries to

FS-2961, Electronics
520 N. Michigan Avenue, Chicago 11, Illinois

Reliance Specials

TIMING MOTOR
8 RPM 115V 60 cye
E. Ingraham Co.  **\$1.95**

GEAR ASSORTMENT
400 small assorted gears. Most are stainless steel or brass. Experimenters dream! Only \$6.50

VERNIER DIAL or DRUM (From BC-221)
DIAL—2 3/4" dia. 0-100 in 360°. Black with silver marks. Has thumbblock. DRUM—0.50 in 180°. Black with silver marks. either \$8.5c

SOUND POWER HANDSET
BRAND NEW
Includes 6 ft. cord.—No batteries or external power source used. \$17.60 pr.

AC LINE CORDS—4 ft. long with molded rubber plug 10c

Sound Powered
Chest Set RCA—
With 24 Ft. Cord
Per Pair
USED \$17.60
NEW \$26.40

400 CYCLE INVERTERS
Leeland Electric Co.
#10800 in: 20-28 V.D.C. 92 A. 8000 R.P.M. Out: 115V.
400 Cye. 1 phase, 1500 V.A. 90 PF. \$24.95

3AG FUSES
AMP Per 100 AMP Per 100 AMP Per 100
1/8 \$4.00 3/4 \$4.00 6 \$3.00
3/8 4.00 4 3.00 10 3.00
1/2 4.00 5 3.00 15 3.00

DELAY NETWORK—ALL 1400Ω
T 114—Approx. 2.2 micro sec. delay. .95¢
T 115 Similar to T 114 with tap brought out. each

BEARINGS

Mfg. No.	ID	OD	Thickness	Price
MRC5028-1	5 1/2	6 1/2	9/16	3.50
MRC7026-1	5 5/64	6 15/64	29/32	4.25
Timken 37625	4 5/16	6 1/4	23/64	2.95
MRC-7021-200	4 1/8	5 9/32	1 1/4	1.00
Norma A 545	2 1/16	2 5/8	25/64	1.75
MRC 106 M2	1 17/64	2 7/16	25/64	1.60
MRC 106 M1	1 13/64	2 7/16	5/8	1.75
Federal LS 11	1 1/8	2 1/2	3/8	1.25
Norma S H R	1 1/8	2 1/8	9/32	.55
Fairair B 541	1 1/16	1 1/2	7/16	.90
Hoover 7203	5/8	1 9/16	7/16	.90
Norma 203 S	5/8	1 9/16	9/16	1.00
SCHATZ	3/4	1 3/8	9/16	1.00
N5 2502-C13M	1/2	1 3/8	1 1/32	.55
ND 3200	25/64	1 5/32	7/32	.45
Norma S 3R	3/8	7/8	5/16	.45
MRC 39 R1	11/32	1 1/32	13/32	.45
ND CW 8008	5/16	5/16	9/32	.45
MRC 38 R3	5/16	55/64		

NEEDLE BEARINGS
TORRINGTON B108 1/2" wide 13/16" 30¢
Brand New Meters—Guaranteed
0-10 ma. D.C. 3 1/2" . . . 3.95 1 0-80 Amp. D.C. 2 1/2" . . . \$2.25

SELENIUM RECTIFIERS
Full Wave 200 MA 115V. \$1.79
Half Wave 100 MA 115V.91
SPAGHETTI SLEEVING—assortment—99 feet. . . \$1.00

TYPE "J" POTENTIOMETERS

Type	Price	Type	Price	Type	Price
100 3/8	1.000 9/16	10K 5/8	1.00K 8 S.S.		
160 S.S.	1.500 1/4 S.S.	15K 1/4	200K 5/8		
150 S.S.	2.000 1/4	15K S.S.	200K S.S.		
300 8 S.	2.000 S.S.	25K S.S.	250K 5/8		
400 3/8	2.500 3/8	50K S.S.	250K S.S.		
400 S.S.	3.000 3/8	70K S.S.	500K 3/8		
500 S.S.	4.000 3/8	80K S.S.	1Meg 3/8		
1,300 3/8	5,000 1/4	100K 7/16	1Meg 8 S.		

* SPLIT LOCKING BUSHING. \$1.50 each

JONES BARRIER STRIPS

Type	Price	Type	Price	Type	Price
2-140Y	\$0.13	4-141W	\$0.30	3-142	\$0.21
3-140YW	.19	5-141	.26	7-142	.42
6-140	.25	6-141 1/2 W	.37	2-50	.39
10-140W	.33	7-141 1/2 W	.36	3-150	.54
10-140YW	.33	7-141 1/2 W	.49		
3-141 1/2 W	.24	8-141 1/2 W	.58		
3-141W	.24	9-141Y	.64		

TIME DELAY RELAY
Eagle Signal Corp., Moline, Illinois
1 Min. Delay. 115 V., 60 Cycle
2 1/2 second recycling time—spring return
Micro-switch contact, 10A • Holds ON as long as power is applied • Fully Cased.
ONLY. \$6.50

AN CONNECTORS
IMMEDIATE SERVICE
PHONE! WIRE! WRITE! YOUR NEEDS

NEW COAXIAL CABLES

RG 5/U	Price per 1,000 Ft.	RG 22A/U	Price per 1,000 Ft.
RG 5/U	\$140.00	RG 22A/U	\$285.00
RG 6	180.00	RG 24	675.00
RG 7	85.00	RG 26	475.00
RG 8	135.00	RG 29	50.00
RG 9	250.00	RG 34	900.00
RG 9A/U	275.00	RG 35	295.00
RG 10	240.00	RG 41	97.00
RG 11	135.00	RG 54A/U	110.00
RG 12	240.00	RG 55	325.00
RG 13	216.00	RG 57	65.00
RG 17	650.00	RG 58	80.00
RG 18	900.00	RG 58A/U	70.00
RG 19	1250.00	RG 59	75.00
RG 20	1450.00	RG 62	75.00
RG 21	220.00	RG 77	100.00
RG 22/U	150.00		

Add 25% for orders less than 500 feet.
* No minimum order—others 250' minimum.

COAXIAL CABLE CONNECTORS



15c	\$1.30	30c	80c	40c	10c
UG 175/U	83-1F	83-1AP	83-1J	83-1R	HOOD
83-1AC	\$0.42	83-22R	.68	UG 85/U	1.75
83-1AP	.30	UG 13/U	1.75	UG 87/U	1.60
83-1B	1.30	UG 21/U	1.20	UG 88/U	1.35
83-1H	.10	UG 21B/U	1.45	UG 187/U	2.05
83-1J	.80	UG 22/U	1.30	UG 175/U	.15
83-1R	.40	UG 24/U	1.30	UG 178/U	.15
83-1SP	.60	UG 25/U	1.25	UG 206/U	1.60
83-1SPN	.60	UG 27/U	1.30	UG 260/U	1.35
83-168	.15	UG 28/U	2.50	UG 281/U	.77
83-185	.15	UG 67/U	2.30	UG 290/U	1.35
83-2R	1.30	UG 58/U	.80	UG 499/U	1.25
83-22AP	1.10	UG 60/U	2.40		
UG 255	2.45	UG 59A/U	2.25		
UG 224/U	1.40	UG 306	2.95		

DIFFERENTIAL
115 V., 60 Cye. \$3.95 ea. 
#C78249
3 3/4" dia. x 5 1/2" long
Used between two C78248's as dampener. Can be converted to 3600 RPM Motor in 10 minutes. Conversion sheet supplied. (Converted) . . . \$4.50
Mounting Brackets — Bakelite for selsyns, and differentials shown above. 35¢ pair

2J1G1 SELSYNS
400 CYCLE—BRAND NEW

POSTAGE STAMP MICAS

mmf	mmf	mmf	mmf	mmf	mmf	mfd	mfd
7 23	47	80	160	390	650	.0012	.0036
7.5 24	50	82	175	400	680	.0013	.004
8 25	51	80	180	470	750	.00136	.0044
8.2 26	56	100	220	500	mfd	.0015	.0056
10 30	80	110	240	510	800	.0016	.006
15 33	62	120	260	560	820	.001625	.0062
18 39	68	125	300	580	910	.002	.0065
20 40	70	130	350	600	.001	.0027	.0088
22 43	75	150	370	620	.0011	.003	.0082

Price Schedule
8.2 mmf to 910 mmf. \$5¢
.001 mmf to .0016258¢
.002 mfd to .0082 mfd. 15¢
.01 mfd 28¢

SILVER MICAS

mmf	mmf	mmf	mmf	mmf	mfd	mfd	mfd
10 40	82	155	325	470	800	.0026	.006
18 47	100	170	350	500	875	.0027	.0051
22 50	110	180	360	510	.0011	.00282	.0056
23 51	115	208	370	525	.0015	.002826	.006
24 60	120	225	390	560	.0016	.003	.0068
27 62	125	240	400	570	.001625	.0033	.0082
30 66	130	250	410	680	.0022	.0039	
39 68	135	270	430	700	.0023	.004	
75 150	275	466					

Price Schedule
10 mmf to 875 mfd. 10¢
.0011 mfd to .0023 mfd. 20¢
.0028 mfd to .0082 mfd. 50¢

PULSE TRANSFORMERS

UTAH—9262 9278 9280 9340
WESTERN ELECTRIC—D166173 D161310
KSS896, KS9365, KS9565, KS9800, KS9862, KS13161
GENERAL ELECTRIC—K2731 80-G-5
JEFFERSON ELECTRIC—C-12A-1318
DENTON COIL—TR1048 TR1049
also 352-7250-2A; 352-7251-2A; T-1229621-60

PRECISION RESISTORS—1/4 WATT—30¢

2	10.48	12.32	14.98	62.54	147.5	700
2.5	10.84	13.02	15.8	79.81	220.4	2,193
3.5	11.25	13.52	16.37	123.8	301.8	3,500
5	11.74	13.89		123.8	366.6	50,148
6.68				125	411.3	59,148

PRECISION RESISTORS—1/2 WATT—35¢

.25	13.15	87	970	6,500	16,700	37,000
.334	13.3	125	1,375	7,000	17,000	45,000
.44	15	178	1,900	7,300	19,860	47,000
.502	18.75	179.5	1,500	8,000	20,150	50,000
.557	25	180	2,500	8,500	21,300	56,000
.627	45	210	2,850	8,800	25,000	59,000
.76	46	240	3,995	10,000	26,667	59,905
1	53	260	4,000	12,000	30,000	68,000
1.4	52	270	4,285	14,825	32,700	70,000
2.04	55.1	290	4,300	15,000	32,888	79,012
3.25	60	298.3	4,451	15,750	33,000	92,000
5.24	61	400	4,750	15,755	33,300	100,000
5.26	65	723.1	5,714	15,810	35,888	180,000
10.58	66	855	5,900	16,000	36,000	
11.1	75					

PRECISION RESISTORS—1 WATT—45¢

.1	2.55	12.8	60	1,530	7,000	50,000
.11	2.58	15	71	1,800	7,800	55,000
.2	2.6	18	80	2,200	8,000	58,000
.31	2.66	27.4	125	2,215	8,250	65,000
.4	3.1	28	250	2,250	8,500	68,000
.361	39	30	270	3,300	10,000	70,000
1.01	4.29	38	312	4,000	12,000	84,000
1.106	4.3	45.5	420	5,000	12,420	90,000
1.21	5.21	54.25	425	5,221	12,500	95,000
2.1						

PRECISION RESISTORS—1 WATT—60¢

100,000	168,100	320,000	399,000	590,000
105,000	220,000	340,000	413,000	600,000
120,000	240,000	348,000	520,000	645,000
128,000	260,000	375,000	522,000	650,000
130,000	270,000	376,000	550,000	700,000
132,000	298,000	390,000	560,000	878,457
148,500	310,000			

1 MEGOHM 1 WATT 1%—\$1.50—5%—60¢
PRECISION RESISTORS—2 WATT—75¢
4,385 5,000 6,000 10,000 19,917 23,000

UNIVERSAL JOINTS ALUMINUM
3/16" hole x 1/2 O.D.
1-1/8" long—50¢
1/4" hole x 1/2 O.D.
1-1/8" long—75¢

OIL FILLED

MFD	V.D.C.	Price	MFD	V.D.C.	Price
125	35,000	\$35.95	4	1,500	\$2.95
125	27,000	28.95	3	1,800	1.59
.1	25,000	25.95	4	1,000	1.95
.25	20,000	19.95	2	1,000	.90
.15-15	8,000	2.75	1.02		

METERS

1 MA DC 3 1/2" R DeJur Mod 310 (0-4KV scale)	\$5.75
3MA DC 2 1/2" R—Simpson black scale	3.35
500 Microamps, DC—2 1/2" round—Sun	4.30
1ma. DC Fan type—1" scale (rem. from equip)	3.95
500 ma. DC 2 1/2" R—General Electric	2.95
2 amp. RF 2 1/2" Sq.—Simpson	3.15
5 amp. AC 4 1/2" R.—JBT	4.11
30 V DC 2 1/2" R—General Electric	3.95
3 amp. RF 3 1/2" R.—Weston	6.00

OIL-FILLED 35 KV AND 50 KV ISOLATION TRANSFORMERS

Pri. 460V 60 cy. Sec. 115V 200 VA Insulated for 50KV
 DC—G. E. Form EIR—36"H x 13"D.....\$125.00
 Pri. 115V 60 cy. Sec. 115V 250 VA Insulated for 35 KV DC—G. E. Form EIR—29"H x 12 1/2"D \$125.00

VOLTAGE DIVIDER

G.E. Cat. 824886G-1 and 9001934G-1 17,246,400 ohms 35KV 70:1 ratio iron wound shielded oil-filled 40"H x 12"D.....\$77.50

2 φ LOW INERTIA SERVO MOTORS

DIEMHL Type FPE 25-11 75 Volt 60 cycle 4 watts—new \$34.50
 KOLLSMAN—45 Volt 60 cycle 4 watts 1500 RPM—new \$22.50

OIL FILLED CONDENSERS

MFD	VDC	Price	MFD	VDC	Price
2	400	5.55	1-5	2000	.95
5-5	400	1.65	.25	2000	1.50
1	600	.55	3	2000	1.30
2	600	.69	1	2000	1.90
2	600R'd	.69	12	2000	8.95
4	600	1.65	1-1	2500	3.85
4	600R'd	1.65	32	2500	15.80
6	600	1.75	.5	3000	2.40
5	600	1.85	.03	4000	1.25
8	600R'd	1.85	3 x 2	4000	2.95
8-8	600	1.95	.1	5000	1.60
4-4-4	600	2.50	.2	5000	2.50
4 x 3	1000	2.50	1	5000	4.88
1	1000	.90	.01-.03	6000R'd	1.65
2	1000R'd	.95	.1	7000R'd	1.79
3.5-5	1000	1.85	.1	7500	2.85
4	1000	1.95	.1	7500	12.50
6	1000	2.50	.045	12KV	8.95
8	1000	3.25	.05	16KV	4.70
1	1200	.85	.075	16KV	8.95
1-1-1	1200	1.85	.25	20KV	19.95
.1	1500	.59	10	330VAC	3.95
.5	1500	1.25	5	440VAC	3.10
4	1500	2.95	7	660VAC	4.25
			8	660VAC	4.50

OILMITES

MFD	VDC	TYPE	Price
.02	600	OM-6002	\$.45
.05	600	OM-6005	.48
.1	600	OM-610	.51
.25	600	OM-625	.55
.5	600	OM-650	.60
1.0	600	OM-601	.85

HIGH VOLTAGE TRANSFORMERS

G.E.—Pri. 115V 60 cy. Sec. 6250V 80 MA—12.5 KV insulation \$18.50
 G.—Pri. 115V 60 cy. Sec. 6250/3850/2600V 56 MA A 12.5 KV insulation \$18.50
 Raytheon—Pri. 115V 60 cy. Sec. 8500/6450V CT 43 MA Hermetically sealed \$22.50

CRYSTAL DIODES

IN21	\$1.19	IN23	\$1.95	IN34	\$.79
IN21A	1.69	IN23A	3.25	IN34A	.95
IN21B	4.00	IN23B	5.25	IN45	.94
IN22	1.09	IN27	1.79	IN52	1.05

ANTENNAS

AT-38A/APT (70 to 400MC).....\$13.70
 AT-49/APR-4 (300 to 3300MC).....13.70
 AN-74B (125 to 150MC).....3.25
 AN-85A (P/O SCR-521).....1.75
 AN-85A (P/O SCR-521).....1.75
 AIA-30M aerial scan.....125.00
 ASB Yagi—5 element 450 to 560MC.....7.00
 ASB Yagi—Double stacked 6 element.....12.70
 ASA Yagi—Double stacked 370 to 430MC.....29.40

RELAYS

Sigma type 4AH—2000Ω, 4 ma DC coil—SPDT contacts—hermetically sealed 5 pin plug-in base \$3.30
 Sigma type 4R—8000Ω, 1 ma DC coil—SPDT contacts—enclosed type 5 pin plug-in base.....\$4.25
 Stevens Arnold type 171 Millisev relay—900 ohm coil—SPST NO contacts.....\$5.50
 Cutler-Hammer and Square D type B-7A contactor—24 VDC coil—SPST NO 200 Amp contacts.....\$4.75
 Price Bros. type 161-M—220 VAC contactor—SPST NO double bk 30A contacts.....\$3.25
 G.E. CR5181-1A6—115 V 60 cy. AC contactor—4PST 30 Amp contacts plus two auxiliary SPDT contacts.....\$14.50
 RBM—115 V 60 cy. AC coil—DPDT 3 Amp contacts.....\$3.20
 Leach type IS21—115 V 60 cy. AC coil—SPST NO double bk 15 Amp contacts—mylex insul.....\$3.25
 Cramer type IC2H—110 V 60 cy. interval timer—two SPST 15 Amp contacts (on 1 hr. off 1 hr.).....\$3.95
 Sperti IS21 vacuum relay switch (for AN/ART-13).....\$9.50
 G.E. 561 vacuum relay switch SPDT 15 Amp contacts.....\$3.50

Terms 20% cash with order, balance C. O. D. unless rated. All prices net F.O.B. our warehouse, Phila., Penna., subject to change without notice.

COAXIAL CONNECTORS



83-1AC	\$.42	83-1RTY	\$.65	83-22R	\$.68
83-1AP	.30	83-1SP	.50	83-22SP	1.15
83-1F	1.30	83-1SPN	.60	83-22T	1.95
83-1II	.10	83-IT	1.30	83-168	.15
83-1HP	.25	83-2AP	1.95	83-185	.15
83-1J	.80	83-22AP	1.40	83-765	.24
83-1R	.40	83-22F	2.10	83-776	.85
		83-22J	1.50		

FULL LINE OF JAN APPROVED COAXIAL CONNECTORS IN STOCK

UHF—N—PULSE—BN—BNC

UG-7/AP	\$6.30	UG-83/U	\$1.85	UG-185/U	\$1.60
UG-12/U	.95	UG-85/U	1.75	UG-191/AP	.80
UG-15/U	1.50	UG-86/U	2.50	MX-195/U	.75
UG-18/U	1.25	UG-87/U	1.60	UG-19/U	2.80
UG-19/U	1.80	UG-88/U	1.35	UG-201/U	1.95
UG-21/U	.95	UG-89/U	1.60	UG-203/U	.85
UG-21A/U	1.50	UG-90/U	1.60	UG-206/U	1.80
UG-21B/U	1.35	UG-98/U	1.85	UG-224/U	1.40
UG-22/U	1.35	UG-102/U	1.15	UG-236/U	3.85
UG-22B/U	1.65	UG-103/U	1.40	UG-245/U	2.25
UG-23/U	1.20	UG-104/U	1.30	UG-254/U	2.25
UG-23B/U	1.90	UG-106/U	.15	UG-255/U	2.45
UG-24/U	1.30	UG-108/U	2.60	UG-260/U	1.35
UG-25/U	1.35	UG-109/U	2.60	UG-261/U	1.60
UG-27/U	1.30	UG-140/U	2.55	UG-262/U	1.60
UG-27A/U	2.95	CW-159/U	.60	UG-273/U	2.25
UG-29/U	1.55	UG-166/U	32.50	UG-274/U	2.75
UG-30/U	2.30	UG-167/U	5.85	UG-275/U	5.50
UG-34/U	16.50	UG-171/U	2.80	UG-276/U	2.75
UG-36/U	17.50	UG-173/U	.40	UG-290/U	1.35
UG-37/U	17.50	UG-175/U	.15	UG-291/U	1.75
UG-57/U	2.30	UG-176/U	.15	UG-306/U	2.95
UG-58/U	.80	UG-177/U	.24		

QUOTATION UPON REQUEST ON ANY CONNECTORS NOT LISTED HERE

M-358	MC-277	PL-259A	PL-325
M-359	MC-320	PL-274	SO-239
M-359A	PL-235	PL-284	SO-214
M-360	PL-259	PL-293	TM-201

93-C 49120 D-163950 ES-685696-5
 93-M 49121A D-166132 ES-689172-1

COAXIAL CABLE

Type	Price Per M Ft.	Type	Price Per M Ft.
RG-5/U	\$140.00	RG-22/U	\$150.00
RG-6/U	180.00	RG-22A/U	285.00
RG-7/U	85.00	RG-24/U	675.00
RG-8/U	135.00	RG-26/U	475.00
RG-9/U	250.00	RG-29/U	50.00
RG-9A/U	270.00	RG-34/U	300.00
RG-10/U	240.00	RG-35/U	900.00
RG-11/U	135.00	RG-54A/U	97.00
RG-12/U	240.00	RG-55/U	110.00
RG-13/U	216.00	RG-57/U	325.00
RG-17/U	650.00	RG-58/U	65.00
RG-18/U	900.00	RG-58A/U	80.00
RG-19/U	1250.00	RG-59/U	70.00
RG-20/U	1450.00	RG-62/U	75.00
RG-21/U	220.00	RG-77/U	100.00

ADD 25% TO PRICES SHOWN FOR QUANTITIES UNDER 500 FT.

GENERATORS

Eclipse-Pioneer type 716-3A (Navy Model NEA-3A) Output—AC 115V 10.4A 800 to 1400cy. 1φ: DC 30 Volts 60 Amps. Brand New.....\$38.50
 Eclipse-Pioneer type 1235-1A, Output—30 Volts DC 15 Amps. Brand New—Original Packing.....\$15.50

TYPE "J" POTENTIOMETERS

Resis.	Shaft	Resis.	Shaft	Resis.	Shaft
60	SS	5K	1/4"	50K	3/8"
60	9/16"	5K	3/8"	100K	1/2"
100	SS	5K	1/2"	100K	SS
200	SS	10K	SS	150K	1/2"
250	1/8"	10K	3/8"	200K	3/8"
500	SS	10K	1/2"	250K	SS
500	5/16"	15K	SS	250K	3/4"
500	1/2"	15K	1/2"	250K	3/8"
500	5/8"	20K	SS	500K	SS
650	1/2"	25K	SS	500K	1/4"
1K	SS	25K	1/4"	500K	7/16"
2K	3/8"	30K	1 1/8"	1 Meg	SS
2500	SS	40K	SS	2.5 Meg	SS
4K	SS	50K	SS	5 Meg	SS
5K	SS	50K	1/4"		

DUAL "JJ" POTENTIOMETERS

50	SS	500	SS	1 Meg	SS
100	SS	1K	SS	2.5 Meg	SS
250	SS	2500	SS	5 Meg	SS
330	SS	10K	SS	1K/25K	3/8"

TRIPLE JJJ POTENTIOMETERS

100K/100K/100K—3/8" 20K/150K/15K—3/8"

SOUND POWERED TELEPHONES

U. S. NAVY TYPE M HEAD AND CHEST SETS
 U.S.I. A260 W.E. D-173013
 A.E. GL832BA0
 ANY TYPE—\$14.88 EACH
 TS-10 Type Handsets.....\$8.92 ea.

3 PHASE INVERTERS

Voltage and Frequency Regulated
 Eclipse Pioneer Type 12121A
 DC Input—24Volts 18 Amps
 AC Output—115 Volts 1.25 Amps 3 Phase
 250 VA 0.7 P.F. 100 Cycles
 12,000 RPM 65°C Temp. Rise
 Brand New.....\$225.00

TEST EQUIPMENT

- Gen. Radio 475B Frequency Monitor.....\$200.00
- Gen. Radio 681A Freq. Deviation Meter.....\$87.50
- 1-222A Signal Generator.....\$79.50
- 1-222B Signal Generator.....\$48.50
- C-D Quietone Filter Type 1F-16 110/220V AC/DC 20 Amps.....\$59.00
- TS-127/U Freq. Meter w/spares.....\$69.50
- TS-143/CPN Oscilloscope.....\$95.00
- Dumont 175A Oscilloscope.....\$225.00
- 31-20 Frequency Meter.....\$49.50
- Gen. Radio 757-PI Power Supply.....\$27.00
- TS-6/AF Frequency Meter.....\$42.00
- 1-130A Signal Generator.....\$42.00
- A.W. Barber Labs. VM-25 VTVM.....\$86.00
- TS-10A/APN Delay Line Test Set.....\$45.00
- TS-19/APQ-5 Calibrator.....\$75.00
- REL W-1158 Frequency Meter 160-220 MC \$32.95
- Gen. Radio 604A G. Ranne Calibrator for ASB, ASE, ASV and ASVC Radars.....\$39.95
- CRV-14AAS Phantom Antenna for Transmitters up to 400 MC.....\$11.75
- 3 CM Pickup Horn Antenna AT-48/U.....\$9.95
- 1-138A Signal Generator—10 cm.....\$185.00
- BC-221 Frequency meter.....\$95.00
- BC-221 Freq. Meter (with modulation).....\$125.00

All items New Except Where noted * (Exc. Used Condition)

MISCELLANEOUS EQUIPMENT

- I-62F Selsyn Indicator.....\$6.95
- SCR-515 compl. w/dynamotor, control box.....69.50
- PE-218 Inverter—28 VDC to 115 VAC 400 cy 1500 VA.....49.50
- G.E. 5D21N3A Inverter—24 VDC to 115 VAC 400 cy 485 VA.....32.50
- Amperex 1B98 Gamma Counter.....9.87
- Powerstat 1226—115/230V Input—0.270V out.....37.00
- T-9 200 ohm Ionization Gauge.....5.95
- EIMAC 35T Ionization Gauge.....22.95
- ATR Inverters 6VDC to 110 VAC 60 cy 75W.....49.50
- R-7/R-2 Receiver.....49.50
- R-78/APS-15 Receiver.....49.50
- FL-8 1020 cycle filter.....2.95
- RM-29 remote control unit.....8.95
- RM-14 remote control unit.....8.95
- RTA-1B 12/24 V dynamotor.....40.00
- BC-1206-CM2 Receiver.....12.95
- E-230/MPG-1 Radar Console.....575.00
- ASB-4 Radar equip. Complete.....69.75
- T-9 ADP-2 less tubes.....16.50
- RCA AV-15 Beacon Recvr.....18.50
- Pioneer Type 800-1B Inverters—28VDC to 120V 800 cy 7 amp AC (used).....22.65
- G.E. Inverter—28VDC to 120 VAC 800 cy 750VA 1 φ.....39.50
- Navy SD-3 Radar complete.....1200.00
- Navy DP-14 Direction Finder complete.....385.00

PULSE TRANSFORMERS

UTAH	9262	UTAH	9318
G.E. 68G-627	9270	Westinghouse 232-AW2	9340
G.E. 68G828	9280	Westinghouse 232-BW-2	9350
G.E. 68G929G1		AN/APN-1 Block Osc.	
G.E. 80G13		Philio 352-7149	
G.E. K-2469A		Philio 352-7150	
G.E. K-2744B		Philio 352-7071	
AN/APN-9 (901756-501)		Philio 352-7178	
AN/APN-9 (901756-502)		Raytheon UK-7350	
AN/APN-9 (352-7250)		W.E. D-161310	
AN/APN-9 (352-7251)		W.E. D-163247	
Westinghouse 132-AW		W.E. D-163325	
Westinghouse 139DW2F		W.E. D-1646	

SPECIAL MOTORS

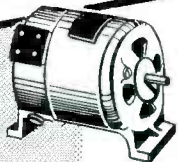

THIS EQUIPMENT IS THE FINEST AVAILABLE, BUILT BY LEADING MANUFACTURERS AND UNCONDITIONALLY GUARANTEED BY WELLS. MANY TYPES NOT LISTED ARE IN STOCK. SEND US YOUR REQUIREMENTS FOR IMMEDIATE QUOTATION.

SELSYNS



DYNAMOTORS



POWER UNITS

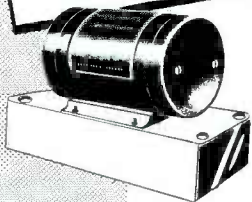

BLOWERS



WELLS SALES, INC.

MOTORS AND SELSYNS

MANUFACTURER	TYPE OR NO.	VOLTAGE	RPM	DIMENSIONS	SPECIAL INFORMATION
Stewart Warner	B-9-2	6VDC	5600	2 1/4" x 2 3/4"	1/2" x 1/2" Lg. shaft
John Oster	62800	12VDC 1.4A	6800	2 1/4" x 3 3/4"	1/2" x 1/2" Lg. shaft. Shunt Wd
General Ind.	D-26-BT	13VDC 9A	6800	2 1/4" x 4"	1/2" x 3/8" Lg. shaft. 1/12 HP
Emerson	7-N	24VDC 24A	100	2 1/4" x 5 1/2"	160 Ft.-Oz. torque
Redmond	40H	24VDC .96A	6000	2 3/4" x 3 1/2"	Complete blower assembly
F. A. Smith	FL	115VAC 60 Cy	6700	6" x 5 1/2" x 5"	100CFM blower (\$12.95)
Western Elect.	D-4272	115VAC 400 Cy	2100	3 1/4" x 4" x 4 1/2"	25 CFM blower
Signal Elect.	D/4496	24VDC .66A	2100	2 1/4" x 2 1/2"	1/4" x 1" shaft. 1/190 HP
Stromberg	A-16B-26R	24VDC .45A	2 1/2" x 3 1/2"	1/4" x 3/4" shaft. .003 HP
Amgio	DEST-8-1R	24VDC	3800	1 1/2" x 2 1/2"	Telephone ringing circuit motor
John Oster	5069267	26VDC	6000	1 1/2" x 2 1/2"	1/8" x 3/8" shaft. Series Rev.
John Oster	KS5996-LO4	27VDC 1.4A	2 1/4" x 4 1/2"	3/8" x 3/8" shaft. 1/40 HP
Delco	M05B	27.5VDC .25A	1 1/2" x 2 1/2"	1/8" x 1 1/2" shaft. 1 1/2 Oz-In Tq.
Western Elect.	E-11500-1	28VDC	9000	2" x 2 1/2"	1/8" x 1/8" shaft. Series Rev.
Bendix	SH-280	28VDC 3.1A	3900	1 1/2" x 5 1/2"	1/2" x 5/8" shaft. Used in ART 13
Bendix	20100	28VDC .1A	2" x 2 1/2"	1/8" x 1 1/2" shaft. 20 Deg. rotation
Electrolux	A-21-E-12R	28VDC .4A	1 1/2" x 2 1/2"	1/8" x 3/8" shaft. Series Rev.
John Oster	D-26-BV	28VDC 3.1A	3900	2 1/4" x 3 1/2"	1/4" x 3/8" shaft. 1/20 HP
Emerson	16875	28.5VDC 1.8A	2200	3 1/4" x 5"	1/4" x 1 1/4" shaft. 1/35 HP
Electrolux	2J1G1	57.5VAC 400 Cy	2 1/4" x 3 1/2"	Selsyn transmitter
General Elect.	5BN38HA10	80VDC .25A	3000	2 1/4" x 5 1/2"	1/4" x 3/4" Lg. shaft
General Elect.	2J1F1	115VAC 400 Cy	2 1/4" x 3"	Selsyn generator
Dialh	11-1	110VAC 60 Cy	4" x 5 1/4"	Synchro repeater selsyn
Bendix	110VAC 60 Cy	3 1/4" x 5 1/2"	Synchro differential selsyn
Bendix	110VAC 60 Cy	3 1/4" x 5 1/2"	Synchro transmitter selsyn

DYNAMOTORS AND POWER UNITS

MANUFACTURER	TYPE OR NO.	INPUT	OUTPUT	DIA.	LGTH.	SPECIAL INFORMATION
Elcor	ML3415-254	27.5VDC 1.5A	250VDC .060A	4"	8 3/4"	With bracket mounting
Elcor	ML3412-42	13.8VDC 2.45A	220VDC .070A	3 3/4"	5 1/2"	No mounting
Western Elect.	DM53AZ	14VDC 2.8A	220VDC .080A	2 3/4"	4 1/2"	With base plate
Westinghouse	1171187A	27VDC 1.4A	285VDC .060A	2 1/2"	4 1/2"	No mounting
General Elect.	5DY82AB52	27VDC 1.5A	285VDC .060A	2 3/4"	4 1/2"	No mounting
Western Elect.	1171091B	27VDC 1.6A	285VDC .075A	2 3/4"	4 1/2"	No mounting
Redmond	5047	27VDC 1.75A	285VDC .075A	2 3/4"	4 1/2"	No mounting
Elcor	ML3415-254	27.5VDC 1.5A	100VDC .150A	3 1/2"	5 1/2"	With base plate
Elcor	ML3420-194	27.5VDC 4.0A	325VDC .200A	3 3/4"	6 1/2"	With base plate
C.Q.R.	355D2BA	27.9VDC 1.25A	220VDC .070A	3 3/4"	5 3/4"	No mounting
Continental	DM310A	28VDC .5A	100VDC .01A	2 3/4"	4 1/2"	No mounting
C.A.Y.	DM32A	28VDC 1.1A	250VDC .060A	2 3/4"	4 1/2"	With base plate
Pioneer	PE86M	28VDC 1.25A	250VDC .060A	2 3/4"	4 1/2"	With base and filter
Bendix	DA-1A	28VDC 1.6A	230VDC .100A	3 3/4"	5 1/2"	No mounting
Redmond	DM5 3A	28VDC 1.4A	220VDC .080A	2 3/4"	4 1/2"	With base plate
Redmond	5056	28VDC 1.4A	250VDC .060A	2 3/4"	4 1/2"	With base plate
Elcor	ML-3420-90	28VDC 3.3A	400VDC .125A	3 1/2"	6 1/2"	With base plate
Continental	DM33A	28VDC 5A	575VDC .160A	3 1/2"	7 1/2"	Cont. duty. No mounting
Winco	41S6	13VDC 13A	250VDC .060A	4" x	8 3/4"	With base plate
Continental	DMX310A	12VDC 2.8A	150VDC .100A	2 3/4"	4 1/2"	Intermittent
Pioneer	PE 55	12VDC .16A	500VDC 0.2A	DIMENSIONS 7 1/4" x 12 1/8" x 13 1/2"		Pwr. Unit W/DM 19G
Westinghouse	PE 94C	28VDC 10.5A	300VDC .260A	8 1/4" x 6 1/2" x 12 1/2"		DYN, Filter and Mounting
			150VDC .010A			Pwr. Unit W/DA3A
			14.5VDC 10A			DYN, Filter and Mounting

ADEL CLAMPS—HUGE STOCK—SEND US YOUR REQUIREMENTS

CHECK WELLS' HUGE STOCK FOR IMMEDIATE DELIVERY OF QUALITY COMPONENTS AT SUBSTANTIALLY LOWER COST

- Resistors • Condensers • Wire and Cable • Co-ax Connectors • Rectifiers
- Transformers • Chokes • Micro Switches, Toggles • Antennas
- Accessories • Electronic Assemblies • Dial Light Assemblies

Seeley 8-4143

MANUFACTURERS AND DISTRIBUTORS: WRITE FOR CATALOG

ORDER DIRECT OR THROUGH YOUR LOCAL PARTS JOBBER

833 W. CHICAGO AVE., DEPT. SL, CHICAGO 22, ILL.

MOTOR GENERATORS

2.5 KVA Diehl Elec. Co. 120 V.D.C. to 120V A.C. 60 cy. 1Ph. APF. Complete with Magnetic Controller, 2 Field Rheos and Full Set of Spare Parts including Spare Armatures for Generator and Motor. Full spec. on request. New.....\$285.00

2 KVA O'Keefe and Merritt. 115V DC to 120V AC. 50 cy. Idles at 3 Ph. syncs motor on 203V. 50 cy. New. Export crated.\$165.00

1.25 KVA Allis-Chalmers. 230 DC to 120 AC. 60 cy. 1 Ph. Fully enclosed. Splashproof. Ball Bearings. centrifugal starter. New, complete with kit of Spare parts.\$175.00

M.G. 164. Holtzer-Cabot Motor: 440V. 3Ph. 60 cy. .90A. 1/3HP. 1750 RPM. Generator: 70V. 3Ph. 146 Cy. .140KVA. Exciter: 115DC. 1A. New.....\$67.50

Type CG-21302. 440V AC. 60 cy., 3Ph., 1500 VA to 875 DC and 300V DC. New.....\$69.50

INVERTERS

Onan MG-215H. Navy type PU/13. Input 115/230. 60 cy. 1 Ph. Output 115, 480 c. 1 Ph. 1200W and 26V DC at 4 amps. New.....\$295.00

G.E. Model 5D-21N3A. Input: 24V. DC. Output: 115V. 400 cy., 485 Va. New.....\$29.50

Leland Elec. Co. Model PE206A. Input: 28V. DC. 38 Amps. Output, 80V., 800 cy. 485 VA. New \$22.50

G.E. J8169172. Input: 28V. DC. Output: 115 400 cycles at 1.5 KVA.....\$32.50

DYNAMOTORS

Navy-Type CA10-211444. 105/130V DC to 13V DC at 40A or 26V DC at 20A. Radio Filtered. Complete with Line Switch. New.....\$89.50

Elec. 64V DC to 110V AC. 60 cy. 1 Ph. 2.04 Amps. New.....\$24.50

Elec. 32V DC to 110V AC. 60 cy. 1 Ph. 0.43 Amps. New.....\$22.50

Type PE94C. For use with SCR522 Transmitter-Receiver. Brand new in export cases.....\$15.00

Cartier 6V DC to 400V DC at 375 mls. New \$39.50

AMPLIDYNES

G.E. Model 5AM211J7. 4600 R.P.M. Motor Compound wound. 150 Watts. Input: 27V DC. Output: 60V DC. Sig. Corps. U. S. Army MG-27-B. New.....\$34.50

Edison type 5AM31N118A. Input: 27 volts, 44 Amps., 8300 RPM. Output: 60V DC at 8.8 amps. 530 Watts. New.....\$22.50

SMALL D.C. MOTORS

G.E. Model 5BA50L12A. Armature 27V D.C. at 8.3A. Field 60V DC at 2.3A. RPM 4000. H.P. 0.5 New.....\$27.50

Electrolux Corp. of Canada. P/O vent fan assembly for SCR-602-T6. 1/35HP. 28.5V. 2.15 amps., 2200 RPM. Price.....\$16.50

Oster type E-7-5. 27.5V. 1/20HP. 3650 RPM. Shunt wound. Price.....\$15.00

Dumors Co. Type EBLG. 24V DC. 40-1 gear ratio, for use with type B-4 Intervalometer. Price \$17.50

SYNCHROS

Ford Inst. Co. Type 5SDG. Brand New...\$22.50

Electrolux Torque Motor.....\$16.50

FL BLOWER

Westinghouse 115v. 400 cy. 17 c.f.m. Includes capacitor. Price.....\$12.50

BASIC SCOPE UNIT

For 80/115V, 400/2600 cycles Part of Panadapter AN/APA-10

Consists of two chassis containing complete high and low voltage supply, 150V DC and 300V DC filtered and regulated and 400V DC and 1200V DC filtered. CR tube socket part of chassis. Uses 3BP1, 31B1, 2-VR150, 5R4GY, 5R4G, 2x2 and 6AK5 DC reinserter tube. Has controls for intensity, focus, aux. focus. Brand New less tubes.....\$29.50

HI-VOLT CAPACITORS

.25 Mfd., 20KV.....\$26.50

.25 Mfd., 15KV.....\$22.50

.5 Mfd., 25KV.....\$34.50

1 Mfd., 15KV.....\$34.50

1 Mfd., 7.5KV.....\$12.50

2 Mfd., 6.0KVA.....\$14.50

TEST EQUIPMENT

TS-127/U Lavole Freq. Meter—375 to 725 MC.

TS-47APR Test Osc. 40-500MC.

TS-487/U Peak to Peak VVM.

AN/APR-1 Receiving sets less tuning units.

R111A/APR-5A Receiver—1000 to 6000 MC.

AU/APR-4 Tuning Units TN-17 (76-300 MC)

AN/APR-4 Tuning Units TN-18 (300-1000 MC).

AN/APR-4 Tuning Units TN-19 (950-2200 MC).

TU-58 Range 7A Tuning Units (110-370 MC).

TC2203 APN-4 Test Sets.

AN/APA-10 Panoramic Adapters 115V/60 cycles.

RADAR

Antenna-Trans-Rec Unit ASG-1.

Radar Set SQ complete with spares.

Modulator type SO-11.

Pulse Timers CUZ-50AQD (SD-5 Radar)

Radar Crystal Units 98.35kc, Raytheon.

1N21B Sylvania Diodes.

Repeater Adapters CBM-50 AFO.

SO Series Accessory Control Panels.

SO Series Transmitter-Receiver unit

CARD 23ABK Bearing Control Units for SO Series.

Auxiliary Rectifier

SG Rectifier Power Units CRP-20ABN.

SG Rectifier Power Unit CRP-20ABM.

SG Modulation Generators CRP-35AAH.

SG Radar Receivers CRP-46ABD-1.

SG Complete trans. RF Coupling Assemblies.

SG Power Control Chassis.

SG Driver Control Assemblies.

SG Complete sets equipment spares.

SG Load Divider Modernization kits.

CRYSTALS—W.E. TYPE CR-1A/R

5810 - 6350 - 6370 - 6470 - 6510 - 6610 - 6670 - 6690 - 6940 - 7270 - 7350 - 7380 - 7390 - 7480 - 9720 Kilocycles. Available in quantity.

Price.....\$1.25 each

REPLACEMENT PARTS FOR BC348 MODELS H, K, L, R AND BC 224 F, K

We can supply for above models only: All coils for Ant., RF., Det. and Osc. bands. All I.F. trans., including C. W. Osc. and xtal filters.

4 gang condensers, engraved front panels, complete dial mechanism assemblies, Dual Volume Controls, Circuit Diagrams, etc.

Write for complete listing.

AMPLIFIERS

GE Servo type 2CV1C1 400 cycle Constant Output Line BC-730C

Synchro Amplifiers for Radar

Intercommunication type BC-605

ANTENNAS

Coast Guard MR-162 Whips 2 3/4 ft.

Microwave types AT-49, AT-38, AS-125

APT-2 Dipole Antennas

TDY Radar Jammer Horns

Paraboloids, Magnesium Dishes 17 1/2" dia.

SCB 634-A (Part of RC-153-B Antenna)

POTENTIOMETERS

W.E. KS-15138 Linear Sawtooth

W.E. KS-8732 for SCR547 Radar

W.E. KS-8801 Motor Driven

SO-1 Parabolic Reflector

RECTIFIERS

G.E. No. 6 RC89F16 for 54 cells 10 amps.

G.E. No. 6 RC133F2—In: 110/220/60/1. Out: 15/30V-75-150A

Mallory APS-20—In: 115/230/60/3. Out: 12/24V-65-130A

Turret Trainer Supply. In: 220/60/3. Out: 28V-130A

RA20 Vibrator Power Supply

Complete specs on request

MISCELLANEOUS

SCR522 Transmitter Receivers Brand New

TCR Transmitters 125 watt Ship to Shore

BC966A Transponders

RT7-AN/APN-1 Receivers

BC-423B Modulators

BC-1366M Jack Boxes—Large quantity

Sweep Generator Capacitors 5/10 mfd.

TERMS: Rated Concerns Net 30, FOB Bronxville, New York. All Merchandise Guaranteed. Prices Subject to Change

400 CYCLE TRANSFORMERS

AUTO. 400 cy. G.E. Cat No. 80G184.

KVA 9455-520P Volts 460/345/200/115. New \$4.95

FILAMENT. 400/2600 cy. Input: 0/75/80/85/105/115/125V. Output: 5V3A/5V3A/5V3A/5V6A/5V6A/6.3V6A/6.35A. New.....\$2.95

THRVRTRON POWER. 400/1600 cy. Raytheon UX-8876. 400/1600 cy. Pri: 115. Sec: 50-0-50V at 1.5A, 6.3V at 1.2A. Test rms. 1780. New.....\$2.75

PLATE WECO KS9560. 400/800 cy. Pri: 115V. Sec: 1350-0-1350 at .057A (2700 V Total). Eleccat shielded. Wt. 2.3 lbs. New.....\$2.95

Plate. Thordarson #T46889. 1650 VA. Pri: 105-120V. 500 cy. 1 Ph. Sec: 5800V. Center tapped.

1.5KV insulation Brand new.....\$49.50

PLATE & FIL WECO KS9555. 400 cy. Pri: 115V. Sec #1: 930-0-930. Sec #2: Three 6.3V windings.....\$3.95

FILAMENT. 400/2400 cps. WECO KS9553. Pri: 115V. Sec: 8.2V1.25A/6.35V1.5A Eleccat shldd. Wt. 0.5 lbs. New.....\$1.95

PLATE & FIL. 400/2600 cy. Pri: 115/80/115V. Sec: #1=1200VDC at 1.5MA. Sec. #2=400VDC at 130MA. Fil. Secs: 6.4V4.3A/6.35V0.8A (ins. 1500V)/5V2A/5V2A.....\$4.95

RETARD. 400 cy. WECO KS9598. 4 Henry 100MA. \$1.75

60 CYCLE TRANSFORMERS

FILAMENT. Raytheon Hypersil Core. Pri: 115V. Sec: 6.3V22A/6.3V2.4A/6.3V2.5A/6.3V0.....\$5.95

for 1700V.....\$5.95

High Resistance Trans. G. E. type Y-3502A.—60 cy. Voltage 11200-135. Inductance 11.5V. Winding 135 Henries. Output: Peak Voltage 22.8KV. Cat. 8318065G1. New.....\$89.50

High Voltage Trans. Westinghouse Pri: 115, 60 cy. Sec: 15,000 C.T., 60 MA. Good for Hi-Pot test set up. C. T. ungrounded.....\$29.50

PULSE TRANSFORMERS

PULSE. WECO K8-9563. Supplies voltage peaks of 3500 from 807 tube. Tested at 2000 Pulses/sec and 5000V peak. Wdg. 1-2=18 ohms. Wdg. 1-3=72 ohms. L of Wdg. 1.3=082H at 100 cps.....\$5.00

PULSE. WECO D-161310. 50 KC to 4MC, 1 1/2" Dia. x 1 1/2" high. 120 to 2350 ohms. New.....\$1.95

RAYTHEON VOLTAGE REGULATOR

Adj. input taps 95-130V., 60 cy. 1 Ph. Output: 115V. 60 Watts. 1/2 of 156 Reg. Wt. 20 lbs. 6 3/4" H x 8 3/4" L x 4 1/2" W. Overload protected. Sturdily constructed. Tropicalized. Special.....\$14.75

RELAYS

Struthers-Dunn 1BXX129. 110 D.C.

Advance type 455C, SPDT, 115 A.C.

Leach type 1154A, SPDT, 115 A.C.

Leach type 1054, BSN 20-28V D.C.

Clare Plug-in base No. 30FMX 115 A.C.

G.E. Plug-in base Sensitive K27853

Allied Control Type BJ 462-1128

Western Electric D-163781 Plug-in

Guardian Time Delay Type B-9-SPDT

Haydon Time Delay 17717 110V/60

SONAR EQUIPMENT

Hotel Train Mechanisms. Navy type 78219, for Model QBG. Underwater Sound equipment. Purpose: To lower or raise projector. Travel 2'3". Includes 1 partial set of spare parts. 1 wooden box per set; Weight and cube per box: 427 lbs., 42.0 cu.

MISCELLANEOUS

Cathode Ray Shields for 3" tube.....\$3.75

Variac type Motor Controls 600 watt.....\$13.50

10 CM Waveguide 90° elbow.....\$20.00

Adel Clamps assorted types—write for samples

Shock Mounts Lord #20.....\$4.40

Shock Mounts U. S. Rubber #5150C.....\$3.30

Commando Pole Jacks (Cook Elec. Co.).....\$1.00

Fusetron (Bus FRLN 50 Ampere 250V).....\$2.25

Switchboard Lamp Receptacles & Jewels.....\$4.40

SOUND POWERED PHONES

Western Electric No. D173312, Type O. Combination headset and chest microphone. Brand new including 20 ft. of rubber covered cable.....\$17.50

Automatic Elec. Co. No. GL843A.O. Similar to above but including Throat microphone in addition to chest microphone. Brand new with 20 ft. rubber covered cable.....\$16.00

U. S. Instrument Co. No. A-260. Complete with 20' cable and plug. Brand new.....\$17.50

W. E. type TS-10M Handset. New.....\$16.50

INDICATORS

ID-24/ARN-9.....\$12.50

ID-14/APN-1.....\$14.50

1-82A.....\$9.75

ID-60/APA-10 Panoramic Adapter converted for 60 cycle operation—complete with tubes and 80 page Tech. Manual.....\$245.00

ELECTRONIC CRAFT
INC.
27 MILBURN ST. BRONXVILLE 8, N. Y.
PHONE: BRONXVILLE 2-0044

SEARCHLIGHT SECTION

WANTED! WANTED!

MILITARY TEST SETS & EQUIPMENT

TS-12, 18, 35, 14, 15, 146, 174, 175, 268, 268, etc. APR, ARC, ART, APS, APA, SCR, BC equipment and parts. Also TUBES, any quantity. WRITE, WIRE OR CALL.



Coaxial Relay, K-101 SPDT-24V DC.	\$ 4.95
Set of R3-15P Coax-Connectors for Above.	1.35
1000 KC Crystal BT cut.	.89
V8-2 Vacuum Switch	6.95
500 Ohm Resistor 8000 ohm SPDT	2.49
RG-59/U Coaxial Cable-75 ohm	
150' roll \$11.95. 300' roll.	22.50
3" Scope Shield	1.29
2000-0-2000 V @ 800 MA Xformer	24.95
15 HY @ 800 MA Choke	4.25
2 mfd 500V V Condenser	

TUBES!! BRAND NEW! STANDARD BRANDS! NO SECONDS! COMPARE! TUBES!!

0A3/VR75 \$1.69	3C24 \$2.25	217C \$8.95	812H \$6.90	8008 \$7.95	WL618 \$37.50	5Y4G \$0.73	6SL7GT \$0.98	12SL7 \$1.05
0B3/VR90 1.29	3C27 4.95	227A 5.95	813 8.95	8011 1.75	WL619 18.95	5Z3 .89	6SN7GT .98	12SN7 .98
0C8/VR105 1.45	3C35 CIB 3.69	250R 12.95	814 2.95	8012 3.95	WL677 34.50	5Z4 .89	6SR7 .75	12SR7 .85
0D3/VR150 1.29	3C45 19.95	250R 12.95	815 2.95	8013 3.95	WL681 22.50	5Z5 .89	6SR7GT .85	12SR7 .85
1B22 3.45	3CP1 2.25	250TH 22.50	816 1.30	8014 29.95	OA2 1.55	6A4LA 1.35	6887 .95	14A4 .98
1B23 1.50	3CP151 1.25	250TL 21.50	817 1.95	8020 1.29	OA4G 1.20	6A6 1.65	6887GT 1.10	14A7 .95
1B24 19.95	3DP1 4.95	270A 2.65	818 12.95	8023 1.65	OB2 1.75	6A7 .99	68U7GT 2.13	14F7 .95
1B26 3.95	3DP1A 6.95	274B 2.65	819 12.95	8001 2.25	OA 1.75	6A8 1.05	68V7 1.25	14F7 .95
1B27 24.50	3DP1 SGA 8.95	283A 2.95	820 14.95	8002 2.25	01A .73	6A8 1.05	68V7GT 1.20	14F7 .95
1B29 2.75	3D21A 1.98	293A 2.95	821 12.95	8003 2.25	01A .73	6AC5GT 1.20	68V7GT 1.20	14F7 .95
1B32 8.95	3E29 14.95	294A 5.75	822 12.95	8004 .75	1A4P 1.30	6AC7 1.23	68V8 .95	14J7 .95
1B36 24.95	3P77 3.95	300B 2.95	823 12.95	8005 2.95	1A5GT .73	6AD7GT 1.05	68V8GT 1.20	14J7 .95
1B38 32.50	3GP1 4.75	304TH 14.95	824 12.95	8006 2.95	1A6 1.65	6AE6G .89	68V9 .95	14J7 .95
1N21 Xtal 1.25	3HP7 3.95	304TL 14.95	825 12.95	8007 2.95	1A7GT .95	6AF6G .95	68V9GT 1.20	14J7 .95
1N21A 4.25	4-65A 1.25	305A 34.95	826 12.95	8008 2.95	1A8 1.80	6AG7 1.95	68V9GT 1.20	14J7 .95
1N21B 4.25	4-125A 26.95	307A 14.95	827 12.95	8009 2.95	1A8GT 1.80	6AG7 1.95	68V9GT 1.20	14J7 .95
1N22 1.35	4-250A 29.95	310A 8.95	828 12.95	8010 2.95	1A9 1.95	6AG7 1.95	68V9GT 1.20	14J7 .95
1N23 1.35	4-500A 29.95	310A 8.95	829 12.95	8011 2.95	1A9GT 1.95	6AG7 1.95	68V9GT 1.20	14J7 .95
1N23A 3.25	4B22 EL15B 9.95	310A/B 24.50	830 12.95	8012 2.95	1A9GT 1.95	6AG7 1.95	68V9GT 1.20	14J7 .95
1N23B 6.95	4B24 EL3C 7.95	327A/5C37 4.95	831 12.95	8013 2.95	1A9GT 1.95	6AG7 1.95	68V9GT 1.20	14J7 .95
1N24 2.50	4B26 12.95	328A 8.95	832 12.95	8014 2.95	1A9GT 1.95	6AG7 1.95	68V9GT 1.20	14J7 .95
1N27 1.69	4B28/2000 8.95	329A 8.95	833 12.95	8015 2.95	1A9GT 1.95	6AG7 1.95	68V9GT 1.20	14J7 .95
1N34A 1.40	4B28 4.95	330A 8.95	834 12.95	8016 2.95	1A9GT 1.95	6AG7 1.95	68V9GT 1.20	14J7 .95
1P23 1.25	4C27/CV92 9.95	330B 8.95	835 12.95	8017 2.95	1A9GT 1.95	6AG7 1.95	68V9GT 1.20	14J7 .95
1P24 1.79	4C27 9.95	330B 8.95	836 12.95	8018 2.95	1A9GT 1.95	6AG7 1.95	68V9GT 1.20	14J7 .95
1P36 2.95	4C35 34.50	331A 8.95	837 12.95	8019 2.95	1A9GT 1.95	6AG7 1.95	68V9GT 1.20	14J7 .95
1S21 1.25	4E25 17.95	331A 8.95	838 12.95	8020 2.95	1A9GT 1.95	6AG7 1.95	68V9GT 1.20	14J7 .95
2AP1 11.95	5AP1 3.69	331A 8.95	839 12.95	8021 2.95	1A9GT 1.95	6AG7 1.95	68V9GT 1.20	14J7 .95
2C21/RR33 .69	5BP1 5.95	331A 8.95	840 12.95	8022 2.95	1A9GT 1.95	6AG7 1.95	68V9GT 1.20	14J7 .95
2C22/7193 .49	5BP1 5.95	331A 8.95	841 12.95	8023 2.95	1A9GT 1.95	6AG7 1.95	68V9GT 1.20	14J7 .95
2C26A .89	5BP1 5.95	331A 8.95	842 12.95	8024 2.95	1A9GT 1.95	6AG7 1.95	68V9GT 1.20	14J7 .95
2C34/RR34 .89	5BP1 5.95	331A 8.95	843 12.95	8025 2.95	1A9GT 1.95	6AG7 1.95	68V9GT 1.20	14J7 .95
2C39 .24	5CP4 12.95	331A 8.95	844 12.95	8026 2.95	1A9GT 1.95	6AG7 1.95	68V9GT 1.20	14J7 .95
2C40 12.95	5CP7 12.95	331A 8.95	845 12.95	8027 2.95	1A9GT 1.95	6AG7 1.95	68V9GT 1.20	14J7 .95
2C43 14.95	5C22 55.00	331A 8.95	846 12.95	8028 2.95	1A9GT 1.95	6AG7 1.95	68V9GT 1.20	14J7 .95
2C44 14.95	5C22 55.00	331A 8.95	847 12.95	8029 2.95	1A9GT 1.95	6AG7 1.95	68V9GT 1.20	14J7 .95
2C46 7.50	5F77 3.25	331A 8.95	848 12.95	8030 2.95	1A9GT 1.95	6AG7 1.95	68V9GT 1.20	14J7 .95
2C51 6.95	5GP1 4.95	331A 8.95	849 12.95	8031 2.95	1A9GT 1.95	6AG7 1.95	68V9GT 1.20	14J7 .95
2D21 1.25	5J2 24.45	331A 8.95	850 12.95	8032 2.95	1A9GT 1.95	6AG7 1.95	68V9GT 1.20	14J7 .95
2E22 1.95	5J2 24.45	331A 8.95	851 12.95	8033 2.95	1A9GT 1.95	6AG7 1.95	68V9GT 1.20	14J7 .95
2E24 4.89	5J2 24.45	331A 8.95	852 12.95	8034 2.95	1A9GT 1.95	6AG7 1.95	68V9GT 1.20	14J7 .95
2E26 2.29	5J2 24.45	331A 8.95	853 12.95	8035 2.95	1A9GT 1.95	6AG7 1.95	68V9GT 1.20	14J7 .95
2E30 2.29	5J2 24.45	331A 8.95	854 12.95	8036 2.95	1A9GT 1.95	6AG7 1.95	68V9GT 1.20	14J7 .95
2E34 9.95	5J2 24.45	331A 8.95	855 12.95	8037 2.95	1A9GT 1.95	6AG7 1.95	68V9GT 1.20	14J7 .95
2E36 29.50	5J2 24.45	331A 8.95	856 12.95	8038 2.95	1A9GT 1.95	6AG7 1.95	68V9GT 1.20	14J7 .95
2E38 29.50	5J2 24.45	331A 8.95	857 12.95	8039 2.95	1A9GT 1.95	6AG7 1.95	68V9GT 1.20	14J7 .95
2E40 29.50	5J2 24.45	331A 8.95	858 12.95	8040 2.95	1A9GT 1.95	6AG7 1.95	68V9GT 1.20	14J7 .95
2E42 29.50	5J2 24.45	331A 8.95	859 12.95	8041 2.95	1A9GT 1.95	6AG7 1.95	68V9GT 1.20	14J7 .95
2E44 29.50	5J2 24.45	331A 8.95	860 12.95	8042 2.95	1A9GT 1.95	6AG7 1.95	68V9GT 1.20	14J7 .95
2E46 29.50	5J2 24.45	331A 8.95	861 12.95	8043 2.95	1A9GT 1.95	6AG7 1.95	68V9GT 1.20	14J7 .95
2E48 29.50	5J2 24.45	331A 8.95	862 12.95	8044 2.95	1A9GT 1.95	6AG7 1.95	68V9GT 1.20	14J7 .95
2E50 29.50	5J2 24.45	331A 8.95	863 12.95	8045 2.95	1A9GT 1.95	6AG7 1.95	68V9GT 1.20	14J7 .95
2E52 29.50	5J2 24.45	331A 8.95	864 12.95	8046 2.95	1A9GT 1.95	6AG7 1.95	68V9GT 1.20	14J7 .95
2E54 29.50	5J2 24.45	331A 8.95	865 12.95	8047 2.95	1A9GT 1.95	6AG7 1.95	68V9GT 1.20	14J7 .95
2E56 29.50	5J2 24.45	331A 8.95	866 12.95	8048 2.95	1A9GT 1.95	6AG7 1.95	68V9GT 1.20	14J7 .95
2E58 29.50	5J2 24.45	331A 8.95	867 12.95	8049 2.95	1A9GT 1.95	6AG7 1.95	68V9GT 1.20	14J7 .95
2E60 29.50	5J2 24.45	331A 8.95	868 12.95	8050 2.95	1A9GT 1.95	6AG7 1.95	68V9GT 1.20	14J7 .95
2E62 29.50	5J2 24.45	331A 8.95	869 12.95	8051 2.95	1A9GT 1.95	6AG7 1.95	68V9GT 1.20	14J7 .95
2E64 29.50	5J2 24.45	331A 8.95	870 12.95	8052 2.95	1A9GT 1.95	6AG7 1.95	68V9GT 1.20	14J7 .95
2E66 29.50	5J2 24.45	331A 8.95	871 12.95	8053 2.95	1A9GT 1.95	6AG7 1.95	68V9GT 1.20	14J7 .95
2E68 29.50	5J2 24.45	331A 8.95	872 12.95	8054 2.95	1A9GT 1.95	6AG7 1.95	68V9GT 1.20	14J7 .95
2E70 29.50	5J2 24.45	331A 8.95	873 12.95	8055 2.95	1A9GT 1.95	6AG7 1.95	68V9GT 1.20	14J7 .95
2E72 29.50	5J2 24.45	331A 8.95	874 12.95	8056 2.95	1A9GT 1.95	6AG7 1.95	68V9GT 1.20	14J7 .95
2E74 29.50	5J2 24.45	331A 8.95	875 12.95	8057 2.95	1A9GT 1.95	6AG7 1.95	68V9GT 1.20	14J7 .95
2E76 29.50	5J2 24.45	331A 8.95	876 12.95	8058 2.95	1A9GT 1.95	6AG7 1.95	68V9GT 1.20	14J7 .95
2E78 29.50	5J2 24.45	331A 8.95	877 12.95	8059 2.95	1A9GT 1.95	6AG7 1.95	68V9GT 1.20	14J7 .95
2E80 29.50	5J2 24.45	331A 8.95	878 12.95	8060 2.95	1A9GT 1.95	6AG7 1.95	68V9GT 1.20	14J7 .95
2E82 29.50	5J2 24.45	331A 8.95	879 12.95	8061 2.95	1A9GT 1.95	6AG7 1.95	68V9GT 1.20	14J7 .95
2E84 29.50	5J2 24.45	331A 8.95	880 12.95	8062 2.95	1A9GT 1.95	6AG7 1.95	68V9GT 1.20	14J7 .95
2E86 29.50	5J2 24.45	331A 8.95	881 12.95	8063 2.95	1A9GT 1.95	6AG7 1.95	68V9GT 1.20	14J7 .95
2E88 29.50	5J2 24.45	331A 8.95	882 12.95	8064 2.95	1A9GT 1.95	6AG7 1.95	68V9GT 1.20	14J7 .95
2E90 29.50	5J2 24.45	331A 8.95	883 12.95	8065 2.95	1A9GT 1.95	6AG7 1.95	68V9GT 1.20	14J7 .95
2E92 29.50	5J2 24.45	331A 8.95	884 12.95	8066 2.95	1A9GT 1.95	6AG7 1.95	68V9GT 1.20	14J7 .95
2E94 29.50	5J2 24.45	331A 8.95	885 12.95	8067 2.95	1A9GT 1.95	6AG7 1.95	68V9GT 1.20	14J7 .95
2E96 29.50	5J2 24.45	331A 8.95	886 12.95	8068 2.95	1A9GT 1.95	6AG7 1.95	68V9GT 1.20	14J7 .95
2E98 29.50	5J2 24.45	331A 8.95	887 12.95	8069 2.95	1A9GT 1.95	6AG7 1.95	68V9GT 1.20	14J7 .95
2E99 29.50	5J2 24.45	331A 8.95	888 12.95	8070 2.95	1A9GT 1.95	6AG7 1.95	68V9GT 1.20	14J7 .95
2E99 29.50	5J2 24.45	331A 8.95	889 12.95	8071 2.95	1A9GT 1.95	6AG7 1.95	68V9GT 1.20	14J7 .95
2E99 29.50	5J2 24.45	331A 8.95	890 12.95	8072 2.95	1A9GT 1.95	6AG7 1.95	68V9GT 1.20	14J7 .95
2E99 29.50	5J2 24.45	331A 8.95	891 12.95	8073 2.95	1A9GT 1.95	6AG7 1.95	68V9GT 1.20	14J7 .95
2E99 29.50	5J2 24.45	331A 8.95	892 12.95	8074 2.95	1A9GT 1.95	6AG7 1.95	68V9GT 1.20	14J7 .95
2E99 29.50	5J2 24.45	331A 8.95	893 12.95	8075 2.95	1A9GT 1.95	6AG7 1.95	68V9GT 1.20	14J7 .95
2E99 29.50	5J2 24.45							

OVER 1,000
DIFFERENT
TYPES

Over 300,000 RELAYS in our Vast Stock

AIRCRAFT SOLENOID CONTACTORS

TYPE B5A



50 Amp Contacts
24VDC, SPST,
Double Make,
Spec. #94-32351A

Allen Bradley, Bulletin
X91419, 100 ohm, #R105 \$1.95
Hart, Cat. No. 692R4, 150
ohm, #R105H...\$1.95
Square "D", Class 9350,
150 ohm, #R25...\$2.25
Cutler Hammer, Bulletin
6041H2B, 100 ohm, #R24
\$2.25

TYPE B4



200 Amp Contacts,
24 VDC, SPST,
Double Make,
Spec. #94-32324A

Hart, Spec. No. 569A, Cat.
No. 694R19, 75 ohm,
#R127A...\$2.95
AutoLite, B4, 90 ohm,
#R174...\$3.50

TYPE B6B



100 Amp Contacts,
24VDC, SPST,
Double Make

Allen Bradley, Part No.
X95395, 65 ohm, #R606
\$3.95

TYPE B8



200 Amp Contacts,
24VDC, SPST,
Double Make,
Spec. #94-32424A

AutoLite, B8, 8 ohm,
#R128...\$2.75
Guardian, 34056, 8 ohm,
#R129...\$3.95
Hart, Cat. No. 694R16A, 8
ohm, #R601...\$3.50
Cutler Hammer, Bulletin
6041H139A, 10 ohm,
#R130...\$3.95
Leach, Part No. 7210-24, 8
ohm, #R602...\$3.95

MAGNECON



200 Amp Contacts,
SPST, Double Make

Holding Current
Automatically
Cut by 90%

305881-2, 36VDC, 14 ohm
Start, 140 ohm Hold,
#R589...\$2.95
305881-3, 72VDC, 60 ohm
Start, 600 ohm Hold,
#R590...\$3.25
805281-4, 120VDC, 200 ohm
Start, 2000 ohm Hold,
#R591...\$3.50

ALLIED BJ



B16D36 24VDC, DPDT 255 ohm
#R420...\$1.55
BJX-42 12 or 24 VDC, SP Dble
break, 240 ohm CT #R226 \$1.25
BJU (Electrical Latching) 6VDC,
41PDT, 18 ohm ea coil, dust-
proof shield, 11 Pin Plug Base
#R435...\$6.95

ALLIED BO & BOY



**HEAVY DUTY
10 AMP. CONTACTS**

B013D35 6VDC, SPDT, double
make, 240 ohm #R06...\$1.25
B01535 24VDC, Dble make and
break, 240 ohm #R238...\$1.30
B09D23 6VDC, 3PDT, 14 ohm #R225...\$2.25
B01332 12VDC, 80 ohm, coil and frame only (no
contacts) #RC-358...40c
BOYX40 12 ma., DPDT, 3940, #R587...\$2.95
BN12D34 24VDC, 4PDT, 227 ohm, #R434...\$3.49

GM 12000 SERIES



**DUAL COIL
10 AMP CONTACTS**

12566 6-12VDC, 3PDT, 45 ohm,
#R593...\$1.95
12889-2 24VDC, 3PDT, 800 ohm
#R594...\$2.95
12792-1 18-24VDC, 3PDT, 100
ohm, #R240...\$1.75
12885-1 24VDC, 1A, 1B, 2C, 300 ohm, #R595 \$3.25

G.E. CR2791 SERIES



CR2791B100P36SP 10,000
ohm 10 ma., 3PDT #R603
\$2.50
CR2791B10613 24 VDC,
3PDT, 180 ohm, 3A
contacts #R237...\$1.25
CR2791B100J42 8-12VDC,
3PDT, 60 ohm, 3A
contacts #R361...\$1.25
CR2791B100J4 4-6VDC,
3DPT, 12 ohm, 3A
contacts #R361...\$1.25
CR2791B100F3 24VDC, 2PDT, 150 ohm, 5A
contacts #R164...98c
CR2791B101V46 12VDC, Dble, make, 100 ohm,
10A contacts, #R165...70c
CR2791D107F3 24VDC, DPDT, 100 ohms, 5A
contacts, ceramic insul. #R229...\$5.95

ARC 1 & 3 MINIATURES



23025 RBM 48VDC, SPDT,
8000 ohm, 6 ma #R128...\$1.50
55251 Telechron, 24VDC,
SPST n.o. (1A) 300 ohm,
#R174...90c
55340 Price, 24VDC SPST
n.o. (1A) 300 ohm
#R170...90c
55342 Telechron, 24VDC, Makes 3 Breaks One
(2As, 1C) 300 ohm, Anti-Capacity Arms, Low
Loss Bakelite Insulation #R171...\$1.25
55526 Cook, 24VDC, Makes 2, Breaks One, (1A,
1C) 300 ohm Ceramic Insulation, #107...95c
55528 G.E. 12VDC, 6PST n.o. (6As), 150 ohm,
#R126...\$1.50
55531 Cook, 12-24VDC, Makes 4, Breaks (2As,
2Cs), 150 ohm #R405...\$1.25
55589 RBM, 24VDC, DPST n.o. (2As), 300 ohm,
#R245...\$1.25
55936 G.E. 24VDC, SPDT, (2As), 250 ohm,
#R102...ea. \$1.25
55837 G.E. 24VDC, Double Make, 300 ohm,
#R108G...\$1.00
55837 RBM, Same as #R108G, #R108R...\$1.25
55837 Allied, Same as #R108G, #R108...\$1.50
23012-0 RBM, 24VDC, SPDT, 250 ohms,
#R172...\$1.25
7251 ARC 24VDC, SPDT, 300 ohm #R406...\$1.25
7252 ARC, 24VDC, DPST, n.o. (2As) 300 ohm,
Anti-Capacity Arms, Ceramic Insulation,
#R354...\$1.25

A.C. TELEPHONE TYPES

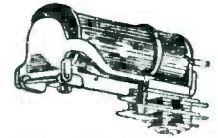

Clare B19553* 24VAC, 2C, 1A #R582...\$3.49
Clare Type C* 110VAC, 2A, 1B #R161... 3.25
Automatic F Type RA 110VAC, 4PDT,
#R159... 4.49
Automatic F type RA 110VAC, DPDT,
#R160... 3.49
* Octal type plug base

DIFFERENTIAL



Dual 8000 coils, Armature
pivoted between poles, all
contacts normally open. High-speed.
Suitable for P.P. bridge or
balanced circuits where dif-
ferential action is required.

COOK 11710/613 DPDT, 6 ma., #R605...\$5.95
Allied 803476 SPDT, 2.5 ma., #B418... 4.95

ROTARY RATCHET RELAYS

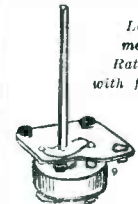

Letex D.O. impulse operated
mechanisms rotate in 30° steps.
Ratchet mechanism has 1/4" shaft
with flats for standard switch wafers.

#33 Mechanism only, 24V, 200
ohm, #R587...\$1.50
#76-2945 Mechanism & Rat-
chet & 3" long shaft, 6V, 1/2
ohm, #R598...\$3.50
#75-3576 Mechanism & Ratchet & 4" long shaft,
6V, 1/2 ohm, #R599...\$3.75
#25 Mechanism Only, 12V, 4.5 ohm,
#R824...\$1.50
#26 Mechanism Only, 6V, 2 ohm,
#R825...\$1.50
Miniature Mechanism Only, 12V, 35 ohm,
#R826...\$1.50
Miniature Mechanism Only, 6V, 10 ohm,
#R827...\$1.50

D.C. SENSITIVE

RBM 23025 6 ma, SPDT, 8000 ohm, #R428...\$1.50
RBM 23025 6 ma., SPDT, 8000 ohm, #R428 1.50
W.E. (Wheelock) KS9685 9 ma, 1A, 1B,
1C, 2000 ohm, #R426... 4.95
Kurman Midget 12 ma., SPDT, 1500 ohm,
#R427... .98
Clare Type J (K102) 6 ma., SPDT, 3500
ohm, #R30... 3.50
Automatic 5035A7 8 ma., 1A, 1300 ohm,
#103... 1.25
Cooke Type C 4 ma., 1A, 8500 ohm, #R596 3.50
Clare B11613 (K101) 2 ma., SPDT, 6500
ohm, #R588... 4.95
Clare A8053 8 ma., 3A, 8500 ohm, #R408... 3.95

POWER

STRUTHERS DUNN CX 1535-A

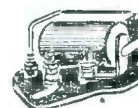

SPST n.o. (1A), 24VDC,
makes at 12 volts 50 ma.;
breaks at 6 volts 25ma., 240
ohm coil, contacts rated at
20 ampere, Power relay
B604...\$2.95

324 CANAL ST., N. Y. C., 13, N. Y. Walker 5-9642

Universal general corp.
YOUR RELAY HEADQUARTERS

A LEADING SUPPLIER OF ELECTRONIC & AIRCRAFT EQUIPMENT

IMMEDIATE DELIVERY -- FULLY GUARANTEED

A C. MOTORS

- TELECHRON SYNCHRONOUS MOTOR, Type B3, 110 V., 60 Cy., 4 W., 2 RPM. PRICE \$5.00 EA.
 TELECHRON SYNCHRONOUS MOTOR Type BC, 110 V., 60 Cy., 6 W., 60 RPM. PRICE \$4.00 EA.
 EASTERN AIR DEVICES, Type J33, Synchronous, 115 V., 400 Cy., 3 ϕ , 8000 RPM. PRICE \$15.00 EA.

HAYDON TIMING MOTORS 110 V., 60 CY.

- Type 1600, 2.2 W., 4/5 RPM. PRICE \$3.00 EA.
 TYPE 1600, 2.2 W., 1/240 RPM. PRICE \$3.00 EA.
 TYPE 1600, 2.3 W., 1 RPM. PRICE \$3.00 EA.
 TYPE 1600, 2.2 W., 1-1/5 RPM. PRICE \$3.00 EA.
 TYPE 1600, 3.5 W., 1 RPM. With shift unit automatic engaging and disengaging shaft. PRICE \$3.75 EA.
 TYPE 1600, 2.2 W., 1/60 RPM. PRICE \$3.00 EA.

SERVO MOTORS

- CK1, PIONEER, 2 ϕ 400 Cy. PRICE \$10.00 EA.
 CK2, PIONEER, 2 ϕ , 400 Cy. PRICE \$14.00 EA.
 CK2, PIONEER, 2 ϕ , 400 Cy., with 40:1 reduction gear. PRICE \$15.50 EA.
 10047-2-A, PIONEER, 2 ϕ , 400 Cy., with 40:1 reduction gear. PRICE \$10.00 EA.
 MINNEAPOLIS HONEYWELL Type B, Part No. G303AY, 115 V., 400 Cy., 2 ϕ , built-in reduction gear, 50 lbs. in torque. PRICE \$10.00 EA.
 MINNEAPOLIS HONEYWELL Amplifier Type G403, 115 V., 400 Cy., Used with above motor. PRICE \$10.00 EA. WITH TUBES

REMOTE INDICATING COMPASSES 26 V., 400 CY.

- PIONEER TYPE AN5730-2 Indicator and AN5730-3 Transmitter. PRICE \$40.00 PER SET
 KOLLSMAN TYPE 680K-03 Indicator and 679-01 Transmitter. PRICE \$15.00 PER SET

D C MOTORS

- DELCO MOTOR, TYPE 50, 68750, 27 V., D.C., 160 R.P.M., with Brake. PRICE \$22.50 EA.
 JAEGER WATCH CO. TYPE 44K-2 Contactor Motor, 3 to 4.5 V. Makes one contact per second. PRICE \$3.50 EA.
 GENERAL ELECTRIC TYPE 5BA10AJ37, 27 V., 0.5 amps., 8 oz. in torque, 250 RPM. PRICE \$10.00 EA.
 BARBER-COLMAN CONTROL MOTOR, Type AYLK 5091, 27 V., 0.7 Amps., 1 RPM. Contains 2 adj. limit switches. 500 In. lbs. torque. PRICE \$9.50 EA.
 WHITE RODGERS ELECTRIC CO., Type 6905 No. 3, 12 V., 1.3 Amps., 1/2 RPM, torque 75 in. lbs. PRICE \$10.50 EA.

ENGINE HOUR METER

- John W. Hobbs Model MI-277. Records running time up 1000 hours. 20 to 30 volts D.C. PRICE \$15.50 EA.

INVERTERS

- WINCHARGER CORP. PU-16/AP, MG750. Input 24 V. D.C., 60 Amps. Output 115 V., 400 Cy., 1 ϕ , 6.5 Amps. PRICE \$100.00 EA.
 HOLTZER CABOT TYPE 149F, Input 24 V. D.C. at 36 Amps., Output 26 V. at 250 V.A., 400 Cy., and 115 V., 400 Cy., at 500 V.A., 1 ϕ , PRICE \$75.00 EA.
 PIONEER TYPE 12117. Input 12 V. D.C., Output 26 V., 400 Cy. at 6 V.A. PRICE \$30.00 EA.
 PIONEER TYPE 12117. Input 24 V. D.C., Output 26 V., 400 Cy. at 6 V.A. PRICE \$30.00 EA.
 PIONEER TYPE 12116-2-A. Input 24 V. D.C., at 5 Amps. Output 115 V., 400 Cy., 1 ϕ at 45 watts. PRICE \$100.00 EA.
 GENERAL ELECTRIC TYPE 5D21NJ3A. Input 24 V. D.C. at 35 Amps Output 115 V., 400 Cy., 485 V.A., 1 ϕ . PRICE \$35.00 EA.
 LELAND PE 218. Input 24 V. D.C. at 90 Amps. Output 115 V., 400 Cy., 1 ϕ at 1.5 K.V.A. PRICE \$47.50 EA.

PIONEER AUTOSYNS

- TYPE AY1, 26 V., 400 Cy. PRICE \$8.50 EA.
 TYPE AY5, 26 V., 400 Cy. PRICE \$8.50 EA.
 TYPE AY14G, 26 V., 400 Cy. PRICE \$15.00 EA.
 TYPE AY14D, 26 V., 400 Cy. PRICE \$15.00 EA.
 TYPE AY54D, 26 V., 400 Cy. PRICE \$10.00 EA.
 TYPE AY131D Precision Autosyn. PRICE \$35.00 EA.

PIONEER AUTOSYN POSITION INDICATORS & TRANSMITTERS

- TYPE 5907-17. Dial graduated 0 to 360°, 26 V., 400 Cy. PRICE \$30.00 EA.
 TYPE 6007-39. Dual Dial graduated 0 to 360°, 26 V., 400 Cy. PRICE \$50.00 EA.
 TYPE 4550-2-A Transmitter, 26 V., 400 Cy., 2:1 gear ratio. PRICE \$20.00 EA.

VOLTAGE REGULATORS

- LELAND ELECTRIC CO. TYPE B, Carbon Pile type. Input 21 to 30 V. D.C. Regulated output 18.25 at 5 Amps. PRICE \$6.50 EA.
 WESTERN ELECTRIC TRANSTAT VOLTAGE REGULATOR Spec. No. V-122855, Load K.V.A. 0.5. Input 115 V., 400 Cy. Output adjustable from 92 to 115 V. PRICE \$10.50 EA.

RATE OR TACHOMETER GENERATORS

- EASTERN AIR DEVICES J36A, .02 V. D.C. per RPM. Max. speed 5000 RPM. PRICE \$17.50 EA.
 ELECTRIC INDICATOR CO. TYPE B68 Rotation Indicator, 110 V., 60 Cy., 1 ϕ . PRICE \$14.00 EA.
 GENERAL ELECTRIC TACHOMETER GENERATOR TYPE AN5531-1. Variable frequency, 3 ϕ output. PRICE \$25.00 EA.
 GENERAL ELECTRIC TACHOMETER GENERATOR TYPE AN5531-2. Variable frequency, 3 ϕ output. PRICE \$30.00 EA.

ALL PRICES
F. O. B.
GREAT NECK
N. Y.

SYNCHROS

- 1F SPECIAL REPEATER, 115 V., 400 Cy. PRICE \$20.00 EA.
 2J1F3 GENERATOR, 115 V., 400 Cy. PRICE \$10.00 EA.
 2J1G1 CONTROL TRANSFORMER, 57.5/57.5 V., 400 Cy. PRICE \$10.00 EA.
 2J1F1 GENERATOR, 115 V., 400 Cy. PRICE \$10.00 EA.
 2J1H1 DIFFERENTIAL GENERATOR 57.5/57.5 V., 400 Cy. PRICE \$10.00 EA.
 SSDG DIFFERENTIAL GENERATOR, 90/90 V., 400 Cy. PRICE \$20.00 EA.
 5G GENERATOR, 115 V., 60 Cy. PRICE \$50.00 EA.
 W. E. KS-5950-L2 Size 5G, 115 V, 400 Cy. PRICE \$10.00 EA.

D C ALNICO FIELD MOTORS

- DIEHL TYPE S.S. FD6-23, 27 V., 10,000 RPM. PRICE \$10.00 EA.
 DELCO TYPE 5069466, 27 V., 10,000 RPM. PRICE \$15.00 EA.
 DELCO TYPE 5069370, 27 V., 10,000 RPM. PRICE \$15.00 EA.
 DELCO TYPE 5072400, 27 V., 10,000 RPM. PRICE \$15.00 EA.

BLOWER ASSEMBLIES

- JOHN OSTER TYPE MX215/APG, 28 V. D.C., 7,000 RPM, 1/100 H.P. PRICE \$10.00
 WESTINGHOUSE TYPE FL, 115 V., 400 Cy., 6,700 RPM, Airflow 17 C.F.M. PRICE \$10.00 EA.
 DELCO TYPE 5068571 Motor and Blower Assembly, P.M. Motor, 27 V., 10,000 RPM. PRICE \$15.00 EA.

GENERAL ELECTRIC D C SELSYNS

- 8TJ9-PAB, TRANSMITTER, 24 V. PRICE \$4.50 EA.
 8DJ11-PCY, INDICATOR, 24 V. Dial marked -10° to +65°. PRICE \$6.00 EA.
 8DJ11-PCY, INDICATOR, 24 V. Dial marked 0 to 360°. PRICE \$7.50 EA.

RECTIFIER POWER SUPPLY

- Hammitt Electric Mfg. Co., Model SPS-130, Input Voltage AC 208 or 230, 60 cycle, 3 phase, 21 amps. Output 28 Volts, 130 amps, continuous duty. 37" high, 22 1/2" wide, 21" deep. Contains DC Volt meter, DC amp meter and 8 point tap switch for variable output voltage. Brand new. Price \$350.00.

MISCELLANEOUS

- SPERRY A5 CONTROL UNIT, Part No. 644836. PRICE \$7.50 EA.
 SPERRY A5 AZIMUTH FOLLOW-UP AMPLIFIER, Part No. 656030, with tubes. PRICE \$5.50 EA.
 SPERRY A5 DIRECTIONAL GYRO, Part No. 656029, 115 V., 400 Cy., 3 ϕ . PRICE \$25.00 EA.
 PIONEER TYPE 12800-1 GYRO SERVO UNIT. 115 V., 400 Cy., 3 ϕ . PRICE \$20.00 EA.
 ALLEN CALCULATOR TYPE C1 TURN & BANK INDICATOR, Part No. 21500, 28 V. D.C. PRICE \$15.00 EA.
 TYPE C1 AUTO-PILOT FORMATION STICK, Part No. G1080A3. PRICE \$15.00 EA.
 PIONEER GYRO FLUX GATE AMPLIFIER Type 12076-1-A, 115 V., 400 Cy. PRICE \$40.00 EA.

INSTRUMENT ASSOCIATES

Write for Catalog NE100

363 GREAT NECK ROAD, GREAT NECK, N. Y.
Telephone Great Neck 4-1147

U. S. Export License-2140

Western Union address:
WUX Great Neck, N. Y.

UNITS • TORQUE UNITS • AMPLIDYNES • INVERTERS • ELECTRONIC SERVO SYSTEMS • TACHOMETER GENERATORS • AUTOMATIC PILOT COMPONENTS • DC MOTORS • SINE-COSINE GENERATORS • U. S. NAVY SYNCHROS • AUTOSYNS • SERVO MOTORS • DYNAMOTORS

SYNCHROS • AMPLIFIERS • ALNICO MOTORS • SHUNT MOTORS • BLOWERS • RATE GENERATORS • SUB-FRACTIONAL HORSEPOWER AC MOTORS • SELSYN

**IMMEDIATE
DELIVERY****Servo-Tek****FULLY:
GUARANTEED****SYNCHRONOUS MOTOR**

Stock #SA-317.

W.E. S-1283228.
For 2 phase
240 cycle
operation.
55 volts.
Price \$9.75 each.**BODINE NSHG-12 MOTOR**

Constant speed

27 v. D-C Govern-
nor controlled
3600 rpm. 1/30th
hp. Stock #SA-39.
Price \$17.50 each.**SELSYN SPECIALS**General Electric types 2J1F1,
2J1G1, 2J1H1 and type 2J1F3
aircraft units. 400 cycle units
designed for use with turret
control systems. Prices on
Request.**Subfractional Horsepower AC Motors**Eastern Air Devices-J-72B—115 v. 400 cy.
1/50 hp. Cont. duty 4700 rpm.
E. A. D. J-31—115 v. 400 cy. 1/100 hp.
E. A. D. J-49B—115 v. 400 cy. 1/250 hp.
E. A. D. J-33—115 v. 3ϕ 400 cy. synchronous.
Diehl FBF-24-1—115 v. 400 cy. 1/100 hp.
Synchron-600—110 v. 60 cy. 1 rpm.
Haydon 36228—115 v. 60 cy. 1 rpm.**MAGNETIC AMPLIFIER**

Pioneer Type 12077

115 V. 400 cy. One Tube Servo Amplifier
using saturable reactor type output trans-
former.

Limited Quantity

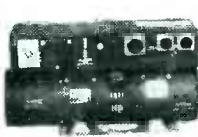
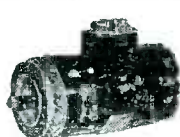
**REVERE
CAMERA MOTOR**27 v. D-C. Split field
series. Approx. 2 1/2"
sq. x 2 1/2" lg. Stock
#SA-315.
Price \$6.75 each.**JA1 MOTOR (D-C)**Electric Specialty. 1/4
hp. 24 v. D-C. (Wing
flap motor.) Stock #SA-
325. Price \$19.50 ea.**3/4 HP DC MOTOR**Electric Specialty Co. HCA315T.
24 volts DC. 3800 rpm. Stock #SA-321.
Special Price \$24.50 each.**C1B THYRATRON**Special offer — Large
quantity C1B thyratrons
available. New, original
packing. Write for quan-
tity quotation.**DC Motor Special**1 1/4 hp. 28 v. DC. mo-
tor. Magnetic brake.
Electric Specialty Co.
type HCA32B.
Large Qty. Available.**INVERTERS**Wincharger PU-7/AP
Input 28 VDC at 160
amps. Output 115 v.
400 cy. 1 ϕ at 2500
VA. Voltage and fre-
quency regulated.
Cont. duty. Stock
#SA-164. Price \$89.50
each.G.E. 5AS131N33
(PE-118) Input
26 VDC at 100
amps. Output 115
v. 400 cy. 1 ϕ at
1500 VA. PF 0.8
W.E. Spec. KS-
5601L1. Stock
#SA-286. Price
\$29.50 ea.PE-218E Inverters
Russel Electric
and Leland. Input
28 VDC at 92
amp. Output 115
v. 400 cycles at
1500 VA. PF 0.9.
Stock #SA-112A.
Price \$49.50 each.Pioneer 12130-4-B
Input 28 VDC at
14 amps. Output
120 v. 400 cy.
single phase at
1.15 amps. (140
VA.) Voltage and
frequency regu-
lated. Made 1949.
Stock #SA-304.
Price \$89.50 each.Leland SD-93—(10285)—Input 28 volts DC
at 50 amps. Output 115 volts three phase
400 cycles at 750 va. 0.90 P.F. Second
output voltage of 26 volts 400 cycles at
50 V.A. Voltage and frequency regulated.
Designed for use with various autopilots.
Stock #SA-209. Price \$99.50 each**Aircraft Generator
Eclipse NEA-3**Output 115 VAC; 10.4
amps 800 cycles at
2400 rpm. Also 30
VDC at 6 amps.
Stock #SA-306. Price
\$39.50 each.**— SERVO-SPECIAL —****Low Inertia Servo Motor
400 Watts Output**115 volt 2 ph. 2 pole. 60 cy. Mfd. by
Pioneer-Bendix.

Uses built in Fan Motor

Navy Type CM-211518A W.E. KS-151182L1
Small Qty. Only**1 H.P. VARIABLE SPEED DRIVE**

Louis Allis Adjusto-Speede

Squirrel Cage A-C motor and an electro-
magnetic clutch and pilot governor. Speed
range 0-1050 rpm. Three phase. 208 v.
operation. 60 cycles. DC excitation 0-10
volts. Small quantity available.**D-C ALNICO FIELD MOTORS****AC-SERVO MOTORS**Pioneer Type CK-2
26 v. 400 cycles fixed
phase, var. phase 49 v.
max. 1.05 in/oz. Stall
torque. Rotor moment
of inertia 7 gm/cm. With
40: 1 gear reduction.
Large Qty.

Prices on Request

**PIONEER CK-17**400 cycles 2 phase, 26 v.
fixed phase. 45 v. max.
variable phase. Built in
gear reduction. Output
shaft speed approx. 4 rpm.
Stock #SA-287. Price \$16.50 each.**FORD SERVO
MOTOR**115 volt 60 cycle two
phase low inertia mo-
tor. 15 watts output.
BuOrd. 207927. Stock
#SA-291. Price \$49.50
each.**Pioneer Servo Motor**Type 10047-2A. 2 ϕ 400 cycle
low inertia. 26 v fixed phase.
45 v. max. variable phase.
Stock #SA-90. Price \$12.50
each.**BLOWER
ASSEMBLY****WESTINGHOUSE
FL Blower**115 v. 400 cy. 17 c.f.m.
Includes capacitor.
Stock #SA-144. Price
\$14.50 ea.**400 CYCLE
AIRCRAFT ACTUATORS**Manufactured by AirResearch. 115 volt 400
cycle operation. 2 1/2" linear travel. Stat.
load 200 lbs. Ten. 75-100 lbs. Comp. 75-100
lbs. Stock #SA-326. Price \$24.50 each.Radio Compass Indicator
I-82F. Compass Indicator.
0-360°-5 in. dial. 26 v. 400 cy.
8-12 v. 60 cy. Ideal position
indicator. Stock #SA-284.

Price \$6.50 each

**PRECISION AUTOSYN**Pioneer Type
AY-150 Control
Autosyn. Preci-
sion type. 26 v.
400 cycle. Stock
#SA-297. Spe-
cial low price
\$14.50 each.**SYNCHRO-SELSYNS**1SF, 1G, 5G, 5F, 5CT, 5HCT,
5SDG, 5DG, 5SG, 5SF, 5HSE,
6G, 6DG, 7G, 2J1F1, 2J1G1,
2J1H1, 2J5FB1, 2J5R1, 2J1-
F3, XX1, X, XV, VII, II, 5V,
etc.**WRITE FOR LISTING**Prices F.O.B. Paterson
Phone Armory 4-3366**Servo-Tek**

products co.

4 Godwin Ave. Paterson, N. J.

SPECIALISTS IN FRACTIONAL HORSE POWER MOTOR SPEED CONTROL

NEW YORK'S RADIO TUBE EXCHANGE

TYPE	PRICE	TYPE	PRICE	TYPE	PRICE	TYPE	PRICE	TYPE	PRICE	TYPE	PRICE
OA2	\$2.00	2J21	17.95	4J41	199.00	307A	4.95	722A	3.95	866A	1.79
OA3	1.50	2J22	17.95	C5B	3.95	310A	7.95	723A/B	17.95	869B	37.50
OB2	2.00	2J26	27.75	5BP1	6.95	311A	7.95	724A	4.95	869BX	35.00
OC3	1.75	2J27	29.95	5BP4	6.95	312A	3.95	724B	6.95	872A	3.95
OD3	1.50	2J31	29.95	5CP1	6.95	323A	25.00	725A	9.95	878	1.95
C1A	4.95	2J32	69.95	5D21	27.50	327A	3.95	726A	6.95	884	1.95
C1B	6.95	2J36	105.00	5JP1	27.50	328A	9.95	726B	56.00	885	1.75
1B21A	2.75	2J38	17.95	5JP2	19.50	350A	7.95	726C	69.00	889R	199.50
1B22	3.95	2J42	150.00	5JP4	27.50	350B	5.95	728AY	27.00	914	75.00
1B23	9.95	2J49	109.00	WE6AK	2.50	357A	20.00	730A	28.95	931A	6.95
1B24	17.95	2J50	69.50	6C21	29.50	368AS	6.95	801A	1.00	954	.35
1B26	2.95	2J61	75.00	C6A	3.95	371B	2.95	802	4.25	955	.55
1B27	19.50	2J62	75.00	C6J	10.95	385A	4.95	803	7.95	956	.69
1B32	4.10	2K25	37.50	7BP7	7.95	388A	2.95	804	13.50	957	.29
1B38	33.00	2K28	37.50	7DP4	10.00	393A	8.95	805	5.95	958A	.69
1B42	19.95	2K29	37.50	12AP4	55.00	394A	7.95	806	25.00	959	1.69
1B51	9.95	2K41	150.00	15E	2.95	MX408U	.75	807	1.69	991	.65
1B56	49.95	2K45	149.50	15R	.95	417A	27.95	808	3.50	E1148	.35
1B60	69.95	2V3G	2.10	NE16	.68	434A	19.95	810	11.00	1280	1.95
1N21	1.35	3B24	5.50	FG17	6.95	446A	1.95	811A	3.15	1611	1.95
1N21A	1.75	3B24W	7.50	RX21	3.95	450TH	45.00	813	8.95	1613	1.38
1N21B	4.25	EL3C	5.95	FG33	12.95	450TL	45.00	814	3.95	1616	2.95
1N22	1.75	3C24	1.95	35T	4.95	464A	9.95	815	3.50	1619	.89
1N23	2.00	3C31	5.95	45 Special	.35	471A	2.75	816	1.45	1622	2.75
1N23A	3.75	3DP1A	10.95	RK39	2.95	527	15.00	829	12.95	1624	2.00
1N23B	6.00	3E29	15.50	VT52	.25	WL530	3.50	829A	13.95	1625	.45
1N26	8.00	SN4	5.50	RK72	1.95	WL531	22.50	829B	15.95	1851	1.85
1N27	5.00	4A1	1.75	RK73	1.95	700A/D	25.00	830B	11.50	2050	1.85
1N43	2.50	4B26	10.95	100TH	9.00	701A	7.50	832	7.95	2051	1.80
1N48	1.00	4C27	25.00	FG105	19.00	703A	6.95	832A	9.95	8012	4.25
1S21	6.95	4C28	35.00	F123A	8.95	705A	3.95	833A	49.95	8013	2.95
2B22	4.95	4E27	17.50	203A	8.95	707A	17.95	834	7.95	8013A	5.95
2B26	3.75	4J25	199.00	211	.95	707B	27.00	836	4.95	8020	3.50
2C34	.35	4J26	199.00	217C	18.00	714AY	17.95	837	2.95	8025	6.95
2C40	20.00	4J27	199.00	242C	10.00	715A	7.95	838	6.95	9001	1.75
2C43	27.00	4J31	199.00	244A	12.95	715B	18.00	845	5.59	9002	1.50
2C44	.90	4J32	199.00	249C	4.95	715C	25.00	849	52.50	9003	1.75
2D21	1.75	4J33	199.00	250TL	19.95	717A	1.95	851	80.50	9004	1.75
2E22	3.75	4J37	199.00	274B	3.00	718AY/EY	48.50	860	4.95	9005	1.90
2E30	2.75	4J38	89.00	304TH	15.00	719A	29.50	861	39.50	9006	.35
		4J39	199.00	304TL	14.50	721A	3.95				

Minimum Order \$25.00

ATTENTION PURCHASING AGENTS AND BUSINESS MANAGERS

WE PURCHASE COMPLETE INVENTORIES AND ELECTRONIC PARTS AND TUBES FOR CASH.
 CAN WE HELP YOU TO OBTAIN URGENTLY NEEDED ELECTRONIC MATERIALS?
 OUR ORGANIZATION IS DEDICATED TO SERVE THE ELECTRONIC FIELD.
 YOU CAN REACH US ON TWX NY1-3235

TEST EQUIPMENT

- | | |
|---------------|-----------------|
| TSK1-SE | TS126 |
| TVN3EV Bridge | TS127 |
| RF4 | TS146 |
| APA10 | TS155 |
| TS10 | TS168 |
| TS12 | TS174 |
| TS15 | TS226 |
| APA28 | TS270 |
| TS33 | LZ Sets |
| TS34 | BC1277 |
| TS34A | BC1287 |
| TS35 | WE 1-147 |
| TS36 | Hazeltine 1030 |
| TS62 | RADAR Sets |
| TS69 | & Parts, APS 3, |
| CY94 | APS 4. |
| TS100 | |
| TS102 | |
| PE102 | |
| TS110 | |

ATTENTION:

**OIL COMPANY ENGINEERS,
 SHIP SUPPLIERS,
 USERS OF SHORAN**

We have for immediate delivery, tested and guaranteed perfect, new,

4C28

SPECIAL PRICE

\$35.00



PHONE WORTH 4-8262

135 LIBERTY ST., NEW YORK 6, N.Y.

RACK-PANEL DESK

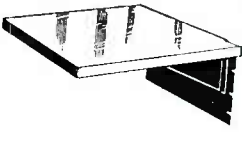

Tough, 1/2" steel panel with reinforced members. Supports heavy duty metal desk 19 1/2" x 22". Standard panel 19" x 10 1/2" H. Ideal space saver for frequency converter, VFO or Receiver. Brand New. While they \$ 95 last

EACH

FULL WAVE BRIDGE SELENIUM RECTIFIERS

Up to 18v. RMS a.c. input—Up to 14v. d.c. output	
Max. d.c. amps.	Price
2	\$2.50
4	4.00
6	6.00
10	7.50
12	9.00
20	15.00
24	18.00
30	21.00
36	27.00

Up to 36v. RMS a.c. input—Up to 28v. d.c. output	
1	3.00
2	4.00
4	8.00
10	14.50
12	18.00
20	28.00
24	36.00
30	42.00
36	54.00

Up to 54v. RMS a.c. input—Up to 42v. d.c. output	
2	6.50
4	8.50
10	11.00
12	48.00
12	60.00

SPECIAL RECTIFIERS ON REQUEST
Low-Voltage Transformers
Voltage Primaries
115v., 60 Cycle

36V-40V at 3.5 amps	\$3.75
24V-1.5A	1.95
8V-1.5A	.98
16V-4.5A	3.75

HI CAP. FILTER CONDENSERS

Cap. Mfd. WVDC	Price
800	15
2000	6
500	200
250	150

A.C. ELECTROLYTICS

Cap. Vac.	Price
13-15 220	\$1.20
20-24 110	1.00
26-30 220	1.35
43-65 110	1.25
43-48 110	1.25
50-75 110	1.25
53-60 220	1.50
61-69 320	1.60
64-72 110	1.25
72-87 110	1.25
75-84 110	1.25
88-106 110	1.50
107-129 110	1.65
130-157 110	1.75
130-150 70	1.50
130-180 110	1.85
158-191 110	1.85
161-190 110	1.75
189-210 110	1.95
200-220 110	1.95
270-300 110	2.10
324-360 110	2.40
378-420 175	3.00
432-480 110	2.75
485-540 110	2.85

OIL CONDENSERS

Mfd. Volt.	Price
5	50
50	50.45
650	20
15	220 AC
0.5	750 AC
0.5	1000
2x0.5	1000
1	1000
1.5	1000
2	1000
4	1000
3	1200
1	1500
1.5	1500
2	1500
0.15	4000
2x0.1	4800
0.1	2500
1.5	6000
2x0.1	7000
0.015	16000
0.016	15000
25	20000
1	25000
5	25000

Inertec Precipitron TYPE FL
Capacitor @ 7500V \$12.95

MANY OTHERS

POWER TRANSFORMERS

Comb. Transformers—115V/50-60 cps input.

CT 77B 5500V/002A, 2.5V/2A 12KV TEST	6.3VCT/6A—4600V TEST	\$12.95
CT 75B 1200VCT/600MA, 2x5VCT/6.2A	6.3VCT/3A, 6.3V/3A	14.95
CT-825 360VCT	3.40 6.3VCT/3A	3.95
CT-626 1500V	.160 2.5/12.30/100	9.95
CT-15A 350VCT	.070 6.3/6, 6.3/1.8, 3 lbs.	2.95
CT-071 110V	.200 33/200, 5V/10, 2.5/10	4.95
CT-378 2300V	4 MA 2.5/2	6.95
CT-367 580VCT	.050 5VCT/3A	2.25
CT-721 550VCT	.100 6.3/1, 2.5VCT/2A	2.95
CT-72 2110VCT	.010 6.3/1A, 2.5VCT/7A	3.25
CT-403 350VCT	.026 MA 5V/3A	2.75
CT-931 585VCT	.036 5V/3A, 6.3V/6A	4.25
CT-610 1250	.002 MA 2.5V/2.1A, 2.5V/1.75A	4.95
CT-137 350VCT	.026 MA 5V/3A	2.75
CT-866 330V	.065 6.3V/1.2, 6.3V/600 MA	1.75
CT-456 390VCT	30 MA 6.3V/1.3A, 5V/3A	3.45
CT-160 800VCT	100 MA 6.3V/1.2A, 5V/3A	4.95
CT-319 660VCT	.085A 5V/2A, 6.3/7.5A, 6.3/3A	3.25
CT-931 585VCT	86 MA 5V/3A, 6.3V/6A	4.95
CT-442 525VCT	75 MA 5V/2A, 10VCT/2A, 50V/200 MA	3.85

Filament Transformers—115V/50-60 cps input.

Item	Rating	Each
FT-781 866 Trans.	2x2.5/5A	\$2.25
FTG-31	2.5V/2.5, 7V/7A (Tape @ 2.5V/2.5A)	
FT-674	8.1V/1.5A	9.95
FT-157	4V/16A, 2.5V/1.75A	2.95
FT-101	6V/.25A	.79
FT-924	5.25V/21A, 2x7.75V/6.5A	17.95
FT-104	6V, 5A	4.79
FT-824	16.4V/2A, 16V/1A, 7.2V/7A, 6.4V/10A, 6.4V/2A	12.95
FT-357	9VCT/45A	14.75
FT-463	6.3VCT/1A, 5VCT/3A, 5VCT/3A	5.49
PT-55-2	7.2V/21.5A, 6.5V/6.85A, 5V/6A, 5V/3A	8.95
PT-986	16V @ 4.5A or 12V @ 4.5A	3.75
PT-38A	6.3/2.5A, 2 x 2.5V/7A	4.19
PT-A27	2.5V/2.5A, 7V/7A TAP 2.5V/2.5A 16KV TEST	18.95
PT-340	2 x 2.5V/3A, 7V/7A—23KV TEST	24.95
PT-038	6.3V/500A WELD	29.45
PT-364	6.3V/2A, 6.3V/4.5A	2.29

Plate Transformers—115V/50-60 cps input.

Item	Rating	Each
PT-919	1200-0/200 200 MA	\$8.95
PT-976	Auto: 120VCT/10 MA	.69
PT-31A	2x300V/5 MA	.79
PT-46A	4080VCT N.L. 3% to 18" 11x6" Wx7" L 20 lbs.	29.95
PT-033	4150V/400 MA	49.95
PT-403	Auto: 70V/1A	2.29
PT-101	1120VCT/770 MA, 590VCT/82 MA, 25 lbs.	24.95
PT-170	Auto: 156/146/137/128—71A	3.29
PT-31A	2x300V/5 MA	.79
PT-976	120VCT/10 MA	.79
PT-12A	260VCT/1.2A	2.95
PT-611	4730VCT/500 MA 12KV INS.	29.95

KLZYSTRON TRANSFORMER

115V, 60 CY.
SEC: 1050V/10MA, MINUS 625V/5MA, 28.3V/4.5MA, 2x2.5V/3A, 6.3V, 3A.
Stock No. CT-341 While a few left at **\$22.45**

115 V—400 CY XFMRs

Stock #	Rating	Price
901695-501	2.7V/60 CY	\$3.45
901698-501	900V/75 MA, 100V/0.4A	4.29
UX8855C	900VCT/0.67A, 5V/3A	3.79
RA6405-1	800VCT/65 MA, 5VCT/3A	3.69
T-48852	700VCT/80 MA, 5V/3A, 6V/1.75A	4.25
352-7098	2500V/6 MA, 300VCT, 135 MA	5.95
KS 9336	1150V/50MA, TAPED 0.625V 2.5V/5A	3.95
M-7474319	6.3V/2.7A, 6.3V/66A, 6.3VCT/21A	4.25
KS 8984	27V/4.3A, 6.3V/2.9A, 1.25V/.02A	2.95
52C080	526VCT/50MA, 6.3VCT/2A, 5VCT/2A	3.75
32332	400VCT/75MA, 6.4V/2.5A, 6.4V/15A	3.85
686631	1150-0/1150V	2.75
80C198	6VCT, 0.0006 KVA	1.75
D-167254	6.4V/8A, 6.4V/1A	2.79
302433-A	6.3V/9.1A, 6.3VCT/6.5A, 2.5V/3.5A, 2.5V/3.5A	4.85
KS 9445	592VCT/118MA, 6.3V/8.1A, 5V/2A	5.39
KS 9585	6.4V/7.5A, 6.4V/3.8A, 6.4V/2.5A	4.79
	ALL CT	
70G30G1	600 VCT/36 MA	2.65
M-7474318	2100V/0.27A	4.95
95-G-45	2000V/.002A, 2000V/NL, 465V/6A, 44V/10A, 6.3V/23.5A, 6.3V/1.8A, 5V/9A, 2X2.5V/175A	17.95

TRANSTAT; IN: 115V, 400 CY. OUT: 75-120V, 6 Amps. **12.95**

FILTER CHOKES

Stock	Description	Price
CH-250	SWING. 2.5-24H/4-05A 10KV Test	\$7.95
CH-8-19	SWING. 0.06H/5A-035H/5A .032 ohms DCR 1KV TEST	3.95
CH-776	1.28 H/130 MA/75 ohms	2.25
CH-344	1.5 H/145 MA/1200V Test	2.35
CH-354	1 H/80 MA	1.29
CH-43A	10 HY/15 MA—850 ohms DCR	1.75
CH-999	15 HY/15 MA—400 ohms DCR	1.95
CH-511	6 H/80 MA—310 ohms DCR	2.45
CH3-501	2x.5H/400 MA	2.79
CH-438M	5 HY 200 MA	1.79
CH-488	10 HY .030A	1.19
CH-791	Dual 1.75-125 HY 100 MA	1.27
CH-86C	Dual .01-3.5 HY 950-75 MA	1.10
CH-981	15 HY .110A	1.59
CH-22-1	1 HY .100A	1.17
CH-779	5 HY 490A	1.25
CH-25A	SW .09/018 HY 3/3A	8.95
CH-922	10000 HY 0 MA	2.75
CH-043	22 HY 80 MA	.98

TYPEWRITER DESK

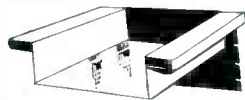

Heavy Duty Stand-ard Panel, 19" x 10 1/2" W x 1/2", tough steel, supporting metal desk well 20" x 15" wide x 4 1/2" deep. Ideal for that new compact rig. Space saving panel may be used to support extra equipment. Attractive gray finish. New. Only a **\$ 95** few left

AUDIO TRANSFORMERS

AT501 Hi-Fi Special: PRI: 3000 ohms P-P/Sec: 4/16/12/50/200 ohms 60-10,000 CY.—1 db 50W. \$3.49
AT152 Hi-Fi Driver Pri: 10,000 ohms Sec: 40,000 ohms TP Grids 50-15 KC/1 db. \$1.99
AT063 Output to I.I.S. or line PRI: 14,200 ohms SEC: 8000/600 ohms \$1.19
AT449 Hi-Fi Driver (5000 ohms) to P.P. output grids (4,000 ohms) 100-10,000 CY. 10 W. 6V6 to PP 805's \$2.39
AT666 Intercon Input: Spkr (-4-8 ohms) to grid (250,000 ohms) \$0.69
AT415 Plate (18,000 ohms C.T.) to line (125 ohms) W-500-600 CY \$1.95
AT858 Plate (10,000 ohms C.T.) to line V.C. (500/125130 ohms) III-FI—50 W. \$6.95
AT070 Mike-or-Line (250 ohms) to grid (250,000 ohms C.T.) \$1.29
AT765 Mike-or-Line (600 ohms) to grid (50,000 ohms C.T.) \$0.89

DYNAMOTORS

Type	Input Volts	Input Amps.	Output Volts	Output Amps.	Radio Set
PE86	28	1.25	250	.060	RC36
DM416	14	6.2	330	.170	RU 19
DM33A	28	7	540	.250	BC 456
PE101C	13/26	12.6	400	.135	SCR 515
			800	.020	
BD AR 93	28	3.25	375	.150	
ZA0515	12/24	4/2	500	.050	APN-1
B-19 pack	12	9.4	275	.110	MARK II
			500	.050	
D-104	12	19	225	.100	
			440	.200	
DA-3A	28	10	300	.060	SCR 522
			150	.010	
			14.5	.5	
5053	28	1.4	250	.060	APN-1
PE73CM	28	19	1000	.350	BC 375
CW21AAX	13	12.6	400	.135	
			800	.020	
			9	1.12	
PE94	28	10	300	.200	SCR 522
			150	.101	
			14.5	.5	

INVERTERS

PE-218-E: Input: 25 28 vdc. 92 amp. Output: 115 v. 350-500 cy 1500 volt-ampers. Dim. 17"x8 1/2"x10". New \$49.50
PE-218-H: Same as above except size: 18 1/2"x8 1/2"x10". New \$49.50
PE200: Input: 28 vdc. 38 amps. Output: 80 v 800-cy. 500 volt-amps. Dim: 13"x5 1/2"x10 1/2". \$22.50

SONAR MOBILE MB-26 Xmtr



Like SR-9 Rcvr, this crystal controlled 8-tube Xmtr goes everywhere, fits anywhere, employs latest v.h.f. techniques! Lets you send clear signal, no matter how grueling the going. Output: 6 watts. Power consumption: equivalent to car bright lights. Just 8 1/2" high, 7" wide, 5 1/2" deep. Built-in antenna relay system, power filter network. Low maintenance — standard tubes. Power and antenna coax connectors on front panel.

The Model MB-26 Transmitter is supplied for amplitude modulation only and may be ordered in any one of the following ranges, less crystals:
27-30 MC 109-132 MC
30-40 MC 144-149 MC
50-54 MC 152-163 MC

\$72.45

SONAR MOBILE SR-9 Rcvr



Indispensable when you must hear what's coming through. In mobile or fixed operation. C.D. CAP or emergency activity. More than a monitor, it's a 9-tube superhet receiver with over-all sensitivity better than 1.0 micro-volt. Tiny — only 4-9/16" high, 5-3/16" wide, and 5-11/16" deep. Yet SR-9 gives you built-in automatic noise limiter, voltage regulated oscillator, precision slide rule dial.

\$72.45

SPECIALS

Time Delay Relay—45 Sec. 115VAC-DC 10A. \$2.29
Carbon Pile Reg., 18V-5V #35X025. \$4.95
ART-13 Driver Trans. 6V6 to P-P 811's. \$1.29
DM 34 Dynamotor, 14V In, 220V, 80 MA out. \$8.95
Sens. Relay: 3.5MA, 13K ohms, 2PST, 2A. \$1.29
Klixon Breaker: Thermal, 35A. \$1.69
T-30 Carbon Mikes.

Buy TOP Radio-Electronic Values!

TRANSMITTING MICAS

Stock No.	Cap.	Test Volts	Type No.	Price Each
5493A*	.01	1000	1445	.35¢
5494A	.02	1000	144T	.40¢
5495A	.006	1200	A 2	.40¢
5496A	.001	1500	PK 15	.20¢
5498A	.004	2500	F	.30¢
5499A	.001	5000	F	.60¢
5600A	.0036	5000	A 2	.60¢
5601A	.15	1000V	X5	\$1.00
5602A	.00007	2500V	3	1.90
5603A	.00005	3000V	15L	1.00
5604A	.0001	5000V	F2L	1.00
5605A	.0008	5000V	F2L	1.00
5606A	.00025	10,000	PL-311	1.95
5607A**	.00015	10,000	PL-315	7.95

* Supplied with Meter Bracket
** D.C. Working Voltage

OTHER TYPES AND SIZES AVAILABLE

MICA CAPACITORS

Sizes from 10 to 7,000 MMFD in CM20, CM30, CM35 and CM40 case sizes. Tan mica and silver mica.

Complete lists with prices available upon request

FT-255 Shock Mount Assembly
95¢ ea.

ART/13 COMPONENTS

G.E. pressure switch
Collins No. 260457000

Stock No. 5730A \$6.50 ea.

Autofone Motor, 1/20th HP, 28 Volt;
4.2 Amp.; 3600 RPM. Collins No.
NY818CB.

Stock No. 5731A \$7.50 ea.

CRYSTAL OVEN

X-Thermotrol Plug-in Crystal Oven. Mfg. by Gasket Engineering Co., Inc. Model XT-200. 6.3 Volts A.C. D.C. 12 Watts. Temperature 75° Centigrade. Holds Crystal with 1/4" Pin Spacing having Maximum Case Size of 3/8" x 7/8" x 1 1/2" High. Complete Oven measures 1 1/2" Diam. x 3 1/2" High. Standard Octal Base.

Stock No. 5283A Price Each \$2.50

G. E. SATURABLE REACTOR

15 KVA. #67G469 \$100.00

HIGH VOLTAGE TRANSFORMER

21,000 volt 100MA. Half Wave oil filled. Maloney Electric Co.

Stock No. 5728A \$300.00

BC939 Antenna Tuning Units. Open Wire Line Type.

Stock No. 5729A \$7.50 ea.

WESTERN ELECTRIC C-114

Loading coils \$2.95 ea.

TOGGLE SWITCHES

Stock No.	Mfg.	Action	Rating	Price
5443A	H & H	S.P.D.T.	6A-125V	35¢
5281A	Carling	S.P.S.T.	10A-125V	39¢
5444A	C-H, (B613)	S.P.S.T.	5A-125V	25¢

OTHER TYPES AVAILABLE

OIL FILLED CONDENSERS

.045 MFD 18,000 Volt Vitamin "Q". One Ceramic Insulated Screw Terminal 1 3/4" x 3 1/4" x 4 3/8" High Can.
Stock No. 5399A. \$4.95

Standard Brand. Mfr. Name on Request

Oil Filled Condenser 10 Mfd. 220 V.A.C. Round Can. 2 1/4" Diameter x 3 3/8" High.
Stock No. 5658A. \$1.95 each

WRITE FOR COMPLETE BULLETIN

OUR FULLY ILLUSTRATED BULLETIN OF ELECTRONIC PARTS IS MAILED AT REGULAR INTERVALS TO MANUFACTURERS AND WHOLESALERS. IN THE CATALOG ARE LISTED AND PICTURED HUNDREDS OF ITEMS OF INTEREST TO PURCHASING AGENTS OF ELECTRONIC PARTS. WE SHALL BE PLEASED TO PLACE YOUR COMPANY'S NAME ON OUR MAILING LIST. PLEASE REQUEST ON YOUR COMPANY LETTERHEAD.

ECLIPSE VOLTAGE REGULATOR

5603A Bendix Eclipse V.R. 1865 volts set Model 2 Style A at 115

Stock No. 5608A \$2.95 ea.

HIGH FREQUENCY RESISTOR

Type MPO-7
50,000 ohm 30 watt

Stock No. 5625A \$1.95 ea.

LARGE STOCKS OF FERRULE RESISTORS AVAILABLE. Write for list or specify your requirements. We also have mounting clips.

WRITE FOR SPECIAL LISTING OF SIGNAL CORPS AND NAVY TRANSFORMERS, CHOKES AND SPECIAL ITEMS.

THORDARSON AUDIO PASS FILTERS

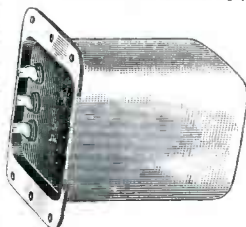

Band pass
800 to 1200
cycles input
10000
ohms —
Output
25000 ohms
Level 10DB

Stock No. T48500 Price to: \$5.50 ea.

STEEL CABINETS

Unpainted. 11" wide x 9" high x 5" deep. Panel space 10" x 9".

Stock No. 3197A Price Each \$1.00

PRICE EACH IN LOTS OF 48, 75¢

AN/APQ-13 MODULATOR UNIT

Signal Corps # 2CK3637-13 W.E. NNO. D-151754. Oil filled modulator containing a pulse amplifier and associated rectifier.

\$125.00 ea.



83-1R COAX CONNECTOR

Stock No. 5657A \$1.60 ea.

6.3 VOLT FILAMENT TRANSFORMERS

Primary 115 Volt 60 Cycle 1600 Insulation Three 6.3 Volt Secondaries

6.3 Volts @ 4.9 Amps.
6.3 Volts @ 4.5 Amps.
6.3 Volts @ 1.1 Amps.

Horizontal Half Shell Mounting. 2 1/4" x 2 13/16" Mounting Centers. 2 13/16" x 3 3/8" Core Size 2 1/2" above Chassis. Solder Lug Terminals—All Terminals Marked.

Stock No. 5251A

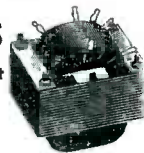

Price \$2.65 Each

W.E. TYPE 400D VARISTOR



Stock No. 5102A Price Each \$2.50

RESISTORS

1/2 Watt 10% AB Type EB Resistors.

Stock No.	Resistance Ohms	Price Per 1000
5472	100,000	550.00
5473	470,000	50.00
5474*	680,000	40.00
5475	820,000	50.00
5476	1.5 Megohm	50.00
5477	2.2 Megohm	50.00
5478	3.3 Megohm	50.00

72 OHM COAX

Plastoid RG-59/U Coax.

Stock No.	Resistance	Price
5324A	1000 Ft. Spools	560.00
5325A	100 Ft. Coils	7.00

PLATE CIRCUIT RELAY

G.E. No. CR2791-B109L39 D.P.D.T. Plate circuit relay. 8000 Ohm coil

Stock No. 5677A Price Each \$1.50

JONES CONNECTORS

Stock No.	Jones No.	Price Each
2090A	P-308-AB	10¢
5093A	P-310-FHT	18¢
3541A	S-408-EB	15¢
5072A	S-404-5B	30¢
5097A	P-406-FHE	25¢

J-38 KEYS

Signal Corps Type J-38 Keys.

Stock No. 5293A Price Each \$5.00

10" PM SPEAKERS

Permalux 10" PM Speaker with 2.15 oz. Magnet. Packed 18 to a carton.

Stock No. 5335A Price Each \$3.35

Carton Lot \$52.00

2 VOLT BATTERY

Signal Corps Type BB-54A 2 Volt 27 Ampere Hour Storage Battery. Non-Spillable Transparent Acid Proof Plastic Case has Built-in Ball Type Hydrometers. 3" x 4" x 5" High. Shipped Dry with Acid in Separate Container. Made by Willard.

Carton of 12 @ \$1.60 Each

Stock No. 5458A Price Each \$1.95

ELECTRO-VOICE—602 DIFFERENTIAL DYNAMIC MICROPHONE

A close talking, noise-cancelling Speech Microphone. 150 Ohm Impedance Dynamic Unit comes complete with press-to-talk switch and 5 Ft. Shielded Four Conductor Cable. Brand New. Individually boxed.

Stock No. 5282A Price Each \$15.00

Terms: Open Account to rated or acceptable referenced accounts. Others Pre-payment or 25% deposit with order, balance C.O.D. Price F.O.B. Chicago and subject to change without notice. Merchandise subject prior sale.

Radio Surplus Corp.

732 South Sherman Street
Chicago 5, Illinois
Phone: HARRISON 7-5923

COMMUNICATIONS EQUIPMENT CO.

10 CM RESEARCH EQUIPMENT

- COAXIAL WAVEMETER, W. E. Transmission type, using type "N" fittings. Calibrated between 3400-4500 MC. \$99.50
- LHTR. LIGHTHOUSE ASSEMBLY, Part of RT39 APG 5 & APG 15. Receiver and Trans. Cavities w/assoc. Tr. Cavity and Type N CPLG. To Recvr. Uses 2C40, 2C43, 1B27. Tunable APX 2400-2700 MCS. Silver Plated. \$49.50
- BEACON LIGHTHOUSE cavity 10 cm. Mfg. Bernard Rice. \$47.50
- MAGNETRON TO WAVEGUIDE Coupler with 721A Duplexer Cavity, gold plated. \$45.00
- SIGNAL GENERATOR, using 417A klystron. 2700-3800 mc. Output approx. 50 mw. 115 vac power supply. With tubes, new. \$425.00
- REGULATED POWER SUPPLY for GL 446 type lighthouse tubes (2C40, etc.) 115 vac. 60 cycles. Panel Mounting. Less tubes. \$32.50
- RT-39/APG-5 10 cm. lighthouse RF head c/o Xmtr.-Recvr-TR cavity, compl. recvr. & 50 MC IF strip using 6AK5 (2C40, 2C43, 1B27 lineup) w/Tubes. \$12.50
- 721A TR BOX complete with tubes and tuning plungers. \$12.50
- McNALLY KLYSTRON CAVITIES for 707B or 2K28. Three types available \$4.00
- TS 268 CRYSTAL CHECKER. \$35.00
- F 29/SPR-2 FILTERS, type "N" input and output. \$12.50
- WAVEGUIDE TO 3/8" RIGID COAX "DOORKNOB" ADAPTER CHOKE. \$12.50
- PLANGE SILVER PLATED BROAD BAND. \$32.50
- AN/APR5A 10 cm antenna equipment consisting of two 10 cm waveguide sections, each polarized, 45 degrees. \$75.00
- POWER SPLITTER: 726 Klystron input dual "N" output. \$5.00
- MAGNETRON COUPLING FOR TYPE 720 MAG. to 1 1/2" x 3" Waveguide. \$35.00
- S BAND SIGNAL GENERATOR, complete with calibrated attenuator, W. E. coax. wavemeter, McNally Klystron Cavity. Regulated power supply operates from 115 V.A.C. 50-1200 Cycles. Manufactured by W. E. \$650.00
- OAJ ECHO BOX, 10 CM, TUNABLE. \$22.50

7/8" RIGID COAX—3/8" I. C.

- RIGHT ANGLE BEND, with flexible coax output pickup loop. \$8.00
- SHORT RIGHT ANGLE BEND, with pressurizing nipple. \$3.00
- RIGID COAX to flex coax connector. \$3.50
- STUB-SUPPORTED RIGID COAX, gold plated 5' lengths. Per length. \$5.00
- RT. ANGLES for above. 1" O.A. \$2.50
- RT. ANGLE BEND, 15" L. O.A. \$3.50
- FLEXIBLE SECTION, 15" L. Male to female. \$4.25
- FLEX COAX SECT. Approx. 30 ft. \$16.50
- 3/8" RIGID COAX. BULKHEAD FEED-THRU. \$14.00

1.25 CM RESEARCH EQUIPMENT

- COMPLETE 24,000 MC RF HEAD, including 2K33 Klystron 3J31 Magnetron and Magnet. all plumbing, and associated circuitry in standard A-N pressurized housing. New. \$1100.00
- Low Power Load. \$29.00
- Waveguide Lengths, 2" to 6" long, gold plated with circular flanges and coupling nuts. per inch. \$2.25
- APS-34 Rotating Joint. \$49.50
- Right Angle Bend E or H Plane, specify combination of couplings desired \$12.00
- 45° Bend E or H Plane, choke to cover. \$12.00
- Mitered Elbow, cover to cover. \$4.00
- TR-ATR-Section, Choke to cover. \$4.00
- Flexible Section, 1" choke to choke. \$5.00
- "S" Curve Choke to cover. \$4.50
- Adapter, round to square cover. \$5.00
- Feedback to Parabola Horn with pressurized window. \$27.50
- 90° Twist. \$10.00

3 CM Research Equipment 1" x 1/2" Waveguide

- 1" x 1/2" waveguide in 5' lengths, UG 39 flange to UG40 cover. per length. \$7.50
- Rotating Joints supplied either with or without deck mounting. With UG40 flanges. each. \$17.50
- 2J42 Magnetron Pulse Modulator. 14kw max. rating 7kw min. Plate voltage pulsed 5.5kV 6.5 amp. 1001 duty cycle. 2.5 usec pulse length max. filament 6.3V 5 amp. includes magnetron mtg. and blower. Requires 3C45 and 2-3R21. New. \$75.00
- TS 268 Crystal Checker. \$35.00
- Bulkhead Feed-Thru Assembly. \$15.00
- Pressure Gauge Section 15 lb. gauge and press nipple. \$10.00
- Pressure Gauge. 15 lbs. \$2.50
- Dual Oscillator-Beacon Mount. P/O APS 10 Radar for mounting two 723A/B Klystron with crystal mts. matching slugs, shields. \$42.50
- Dual Oscillator, Mount. (Back to back) with crystal mount, tunable termination attenuating slugs. \$18.50
- Directional Coupler. UG 40/U Take off 20 DB. \$17.50
- 2K25/723 AB Receiver local oscillator Klystron Mount, complete with crystal mount. Tunable and choke coupling to TR. \$22.50
- TR-ATR Duplexer section for above. \$8.50
- CU 105/APS 31 Direction Coupler 25 DB. \$25.00
- 723AB Mixer-Beacon dual Osc. Mnt. w/xtal holder. \$12.00
- Waveguide Section 12" long choke to cover 45 deg. twist & 2 1/4" radius. 90 deg. bend. \$4.50
- Twist 90 deg. 5" choke to cover w/press nipple. \$6.50
- Waveguide Sections 2 1/4" ft. long silver plated with choke flange. \$5.75
- Rotary joint choke to choke with deck mounting. \$17.50
- 3 cm. mitered elbow "E" plane unplated. \$12.00
- UG 39 Flanges. \$1.85
- UG 40 Chokes. \$1.00
- 90 degree elbows. "E" or "H" plane 2 1/4" radius. \$12.50
- 90 degree twist 6" long. \$8.00
- 45 degree twist. \$8.00
- 40KW X BAND Radar, complete as described and illustrated in July 1951 PROCEDURE
- APS-4 Under Belly Assembly, less tubes. \$375.00

1 1/4" x 5/8" WAVEGUIDE

- Mitered Elbow II Plane UG51-UG52. \$12.00
- 6" St. sect. choke to choke. \$3.50
- CG 98B/APQ 13 12" Flex. Sect. 1 1/4" x 5/8" OD. \$10.00
- X Band Wave GD. 1 1/4" x 5/8" O.D. 1/16" wall aluminum. per ft. 75c
- Slug. Tuner Attenuator W. E. guide. Gold plated. \$6.50
- Bi-Directional Coupler, Type "N". Takeoff 24 d.b. coupling. \$27.95
- Bi-Directional Coupler, UG-52, Takeoff 25 d.b. coupling. \$24.95
- Waveguide-to-Type "N" Adaptor, Broadband. \$22.50

PULSE EQUIPMENT

- MIT. MOD. 3 HARD TUBE PULSER: Output Pulse Power 144 KW (12 KV at 12 Amp). Duty Ratio: .001 max. Pulse duration: 5, 1.0, 2.0 microsec. Input voltage: 115 v 400 to 2400 cps. Uses: 1-715B, 4-829-B, 3-72's, 1-73. New. \$110.00
- APQ-13 PULSE MODULATOR. Pulse Width .5 to 1.1 Micro Sec. Rep. rate 624 to 1348 lps. Pk. powr. out 35 KW Energy 0.018 Joules. \$49.00
- TPS-3 PULSE MODULATOR. Pk. power 50 amp, 24 KW (1200 KV pk); pulse rate 200 lps. 1.5 microsec. pulse line impedance 50 ohms. Circuit series charging version of DC Resonance type. Uses two 705-A's as rectifiers. 115 v. 400 cycle input. New with all tubes. \$49.50
- APS-1C MODULATOR DECK. Complete, less tubes. \$75.00

PULSE NETWORKS

MULTI SECTION PULSE NETWORK: ALL RATINGS 8KV Z=50 OHMS, "E" CKT.			
Pulse Length	PRR	Sections	
.25	1600	2	
.50	800	2	
2.6	400	4	
5.20	200	4 + 4	
Physical Size: 2" x 10 3/8" x 5 3/8"			\$47.50

- 15A-1-400-50: 15 KV, "A" CKT. 1 microsec 400 PPS, 50 ohms imp. \$27.50
- G.E. #4E3-5-2000-501P2T. 6KV. "E" circuit, 3 sections .5 microsecond, 2000 PPS, 60 ohms impedance. \$6.50
- G.E. #3E (3-84-810) (8-2-24-405) 50P4T: 3KV. "E" CKT Dual Unit. Unit 1, 3 sections, 0.84 Microsec. 810 PPS, 50 ohms imp. Unit 2, 3 Sections, 2.24 microsec. 405 PPS, 50 ohms imp. \$6.50
- 7.5E3-1-200-67P. 7.5 KV. "B" Circuit, 1 microsec 200 PPS, 67 ohms impedance, 3 sections. \$7.50
- 7.5E4-16-60, 67P. 7.5 KV. "E" Circuit, 4 sections 16 microsec. 60 PPS, 67 ohms impedance. \$15.00
- 7.5E33-200-6FT. 7.5 KV. "E" Circuit, 3 microsec 200 PPS, 67 ohms imp. 3 sections. \$12.50

PULSE TRANSFORMERS

- G.E.K. -2744-A. 11.5 KV High Voltage, 3.2 KV Low Voltage @ 200 KV per. (270 KW max.) 1 microsec. or 1/microsec. @ 600 PPS. \$39.50
- W.E. -KS 9800 Input transformer. Winding ratio between terminals 3-5 and 1-2 is 1:1.1, and between terminals 6-7 and 1-2 is 2:1. Frequency range: 380-520 cps. Permalloy core. \$6.00
- W.E. #D169271 Ili Volt input pulse Transformer. \$27.50
- G.E. K2450A. Will receive 13KV, 4 micro-second pulse on pri. secondary delivers 14KV. Peak power out 100KW G. E. \$34.50
- G.E. K2748A. Pulse Input line to magnetron. \$7.50
- Ray UX 7896—Pulse Output Pri. 5v, sec. 41v. \$7.50
- Ray UX 8442—Pulse Inversion—40v + 40v. \$7.50
- Ray UX 7361. \$5.00
- PHILCO #352-7250, 352-7251
- UTAH #9262, 9332, 9278

MICROWAVE TEST SETS X BAND POWER METER

Consists of thermistor mount and bridge, microammeter, rough attenuator. X-Band Waveguide thru-out. For power measurements anywhere in the 9000 MC band.

BROADBAND TEST OSCILLATOR

Freq. coverage 50-3000 MC. By direct calibration and interpolation anti-backlash gear drive, compact, portable. Operates from any 115V source or battery source. New, with all tubes. \$425.00

TS 102/AP	TS 226	TS 56A/AP	CS60-ABW
TS 47/APR	TS 250/APN	CW60-ABM	I-58
TS 36/AP	TS 89	LU-1	I-222
TS 12 UNIT 2	I-203-A	LU-3	I-185
Q METER	TS 11/AP	TS 159	TS 268/U
TS 69/AP	BC 438		

Send for Further Information and Prices

POWER EQUIPMENT

- STEP DOWN TRANSFORMER: Pri. 440/220/110 volts a.c. 60 cycles. 3KVA. Sec. 115v. 2500 volt insulation. Size 12" x 12" x 7". \$40.00
- PLATE TRANSFORMER: Pri. 117 v. 60 cy. Sec. 17,600 @ 144 ma. with choke. Oil immersed. Size: 26" x 29" x 13" American. \$120.00
- FIL. TRANS. UX6899. Pri. 115 v. 60 cy. Sec. Two 5 v. 5.5 amp. wds. 29 \$24.50
- VOLTAGE REG. Transtat. Amertran type III 2 KVA load, Input: 90/130 v. 50-60 cy. output 115 v. \$40.00
- UX 6301 (Raytheon): Pri. 110 v. 60 cy. 1 pl. Sec.: 22,000 v. 234 ma. 5.35 KVA. Dim.: 23" x 24" x 10 1/2". Low capacitance. \$185.00
- FIL XFMR: Kenyon: Pri.: 210/225/230/235/240 vac. 60 cy. Sec.: 11 v. 35 amp. 10 1/2. 35 amp. et; 7.5 v. 35 amp. et; 5 v. 35 amp. et #S-10768. \$37.50
- FIL TRANS. KS8767: Pri. 115 v. 60 cy. Sec. 2 wds. v. @ 5 amps each 15 KV test. \$15.00

RADAR SETS

- APS-2, Airborne. 10 CM. Major Units. New.
- APS-4, Airborne. 3 CM. Compl. New
- APS-15, Airborne. 3 CM. Major Units. New
- SO-4, Submarine. 200 MC. Compl. New
- SE, Shipboard. 10 CM. Compl. New
- SF-1, Shipboard. 10 CM. Compl. New
- SJ-1, Submarine. 10 CM. Compl. Used
- SL-1, Shipboard. 10 CM. Compl. Used
- SN, Portable. 10 CM. Compl. Used
- SO, Portable. 10 CM. Compl. Used
- SO-1, Shipboard. 10 CM. Compl. Used
- SO-2, Portable. 10 CM. Assual.
- SO-8, Shipboard. 10 CM. Compl. Used
- Mark 4, Gunlaying. 800 MC. Less Ant. Used
- Mark 10, Gunlaying. 10 CM. Compl. New
- CPN-3, Beacon, CM. Major Units. Used
- CPN-8, Beacon, 10 CM. Compl., Less Ant. New
- SCR-533, IFF/AIR, 500 MC. New

VARIATORS

D-167176	\$.95
D-172155	\$2.25
D-168687	\$.95
D-171812	\$.95
D-171528	\$.95
D-162356 (308A)	\$1.50

THERMISTORS

D-166283	\$1.50
D-167332 (tube)	\$1.50
D-170396 (bead)	\$1.50
D-167613 (button)	\$1.50
D-164699 for MTG.	\$2.50
"X" band Guide	

MAGNETRONS

2127	2138 Pkg.	5130
2131	2139 Pkg.	718DY
2121-A	2149	720BY
2122	2161	725-A
2126	2162	730-A
2132	3J31	700 A, B

All merch. guar. Mail orders promptly filled. All prices, F.O.B. N.Y.C. Send M. O. or Chk. Only shipping chgs. sent C.O.D. Rated concerns send P. O.

COMMUNICATIONS EQUIPMENT CO.
131 Liberty St., New York, N. Y. MR. CHAS. ROSEN Dept. E-2 Phone Main 4-8373

— THE BEST IN ELECTRONIC SURPLUS —

GENERAL ELECTRIC VOLTAGE REGULATOR & POWER SUPPLY MODEL 3GVD14B3



Output 750 volts up to 100 ma; complete power supply using 8 tubes, with selector switch for regulating or non-regulating. Operates from 110 V., 60 cycles AC. NEW units, less tubes, with operational data and diagram. EACH\$24.50

ECLIPSE PIONEER TYPE C-14 MAGNESYN UNIT

Per W.E. Spec., KS-5899-L01 excitation 26 volts 400 C.P.S. current drawn 200 to 500 MA. Shaft locking arrangement overall dim. 2 1/4" dia. 2 1/4" long. .812" x 2.562" Mtg. centers. NEW Units. Price, EACH\$7.50



INDUSTRIAL CAPACITORS

TYPE 18F75

50-50-50 mfd., Delta connected, 90 V. AC, 60 cps. All NEW, packaged capacitors. For power-factor correction, etc. Large quantity available.

EACH\$7.00

REVERSIBLE 1/2 HP AIRCRAFT MOTOR

GE Model 5BA50-L157, 4,000 RPM. Volts—27 Field and 60 V. Armature. Wt 13 lbs. NEW units, individually packed. Approx. 300 available, at.....\$10.00 EACH

Capacitor-Transformer, GE Model 69-G-210, 132/200 Volts, Kva 1.42/23, 140/10 Watts, 60 cycles. NEW units, packaged. EACH\$10.00

Overload Relay, GE type CR-5882-C1G, rated at 250 V. max. NEW, individually packaged.

Low Pressure Switches, GE type 2927D100-J1. NEW. EACH\$3.00

Radar Fil. Transf. WE. Spec. D-122882, RMS Test 30 Kva. Pri.—115 V., 50/70 cycles. Operating max D.C. 15 Kv., Sec. #15V. at 10 amps, #2 5V. at 10 amps, #3 5V. at 20 amps. New Units, cased. EACH....\$15.00

"SNOOPERSCOPE" TUBES, British-Infrared Image Converter Tubes, with matching Bausch & Lomb front-end Lens. TUBE, EACH \$5.50; LENS, EACH \$10.00.

Immediate Delivery from Stock

Cable: Telemarine, N. Y.
Tel. LOngacre 4-4490-1

1-KW—FM 88-108 MC BROADCAST POWER AMPLIFIERS

Latest design and production, mfd. by G.E. Model BF-1-A. Not War Surplus! RF AMPLIFIER includes full Power Supply in modern, streamlined cabinet, 75" high 30-3/4" wide, 25-1/4" deep. Operates from 208/230 volts, 50/60 cycles 1-phase A.C. With tubes; 2-GL-8008, 2-GL-7C29, and 1-6H6. All NEW equipment—export packed. PRICED AT A FRACTION OF ORIGINAL COST!!

WRITE FOR COMPLETE DESCRIPTION AND PRICES

TRANSMITTERS

T4/FRC, with Modulator MD 1/FRC, and PP-1/FRC, Power Supply. RCA-ET 4332 and 4336. TDE, TBK, 8010, 8003, for Ships. ATD, for Aircraft. BC-319, BC-604, BC-684, etc. RCA-2.5 KW. Converted to R. F. Heater, 2.5 KW- output. Freq. range 10.7 to 14.4 mc. Consists of 2 cabinet units; Oscillator unit uses two 3Z7R tubes forced air-cooling; Power supply uses six 872A rectifiers, with requisite meters and relay controls. Operates from 230 or 460 V., 50-60 cycles, 3 phase A.C. PRICE AS IS.....\$1,400.00 TSI 500W, Simultaneous Radio Range and Telephone Transmitter. Frequency 200-400 KC. Mfd. for CAA by Federal Tel. Co. BC-797, 50 Watt AM Transmitter. Freq. 110 to 130 MC, Xtal Control. Operation—110V, 60 cycles AC. TDQ Transmitters, 100-156 MC, 45 watts AM output. Reconditioned to like new.

MANY OTHERS!

TRANS-RECEIVERS

SCR-509 & 510, SCR-511, SCR 669 & 610, SCR-522, LINK Model 1498, TCS with 12/24/230 DC and 110V, AC Power Supplies, SCR-508/528/668/628. Jefferson Travis, Model 350-A, Transmitter-Receiver, 50 W. output, 1.5 to 12.0 mc, 5 channels operation—1 VFO and 4 X'tal—both transmitter and receiver. Power Supply operates from either 12/24/32/115 V.D.C., or 115 V. AC, 60 cycles. With Ant. Loading Coil unit, handset, key, & instruction book. Complete.

AUDIO SOUND

Beachmaster 250 W.; Western Elec. Model HLAS—500W.; RCA 25W. (12V.) Mobile; RCA MK-2817-E Amplifier, 1,000 Watts (2—500 Watt Channels); W.E. Speaker Units D-173246. (25-30 Watts) and D-173232A (50-60 Watts), considerable quantity available.

TEST EQPT.

BC-221, I-222-A Signal Generator, 100-156 MC, with crystal calibrator, for 115 V. 60 cycles AC. TU-56, TU-57, TS-45, TS-143, I-148, TS-305, TS-143/CPM - 1 Synchroscope. Others.

RADAR

SCR-545-A, Complete in Trailer Trucks, with or without 25 KVA Gas-Engine Generator Unit. Hundreds of radar components, plumbing, magnets, tubes, transformers, etc.

RECEIVERS

R15M, R15S, DZ-2 Direction-Finders with Loops, SCR-206 Direction Finders with Loops, SCR-291 Indicators and Accessories. Others. CRV-46136, 100 to 1500 KC, part of DP-13 Radio Eqpt. R-89/ARN-5A Glide-Path Receiver, with crystals. NEW. RT-3/ARN-1 Radio Receivers, New. Model ZB-3, Aircraft Homing Adapters, with plugs and accessories. New Eqpt.

Willcox 36A Rectifier-Power Supply, for 3 KW modulated transmitter. Designed for use with 4 or more 96C 3 KW Transmitters and 50A Modulator. New, Unused. WRITE FOR PRICE.

RADIOSONDE AN/AMQ-1, Meteorological Balloon transmitter with self-contained instruments. New Units, with slide-rule temperature evaluators and spare (sealed) humidity elements. Large quantity available. Receiving and Recording supplementary eqpt. also available. Type AN/FMQ-1. WRITE FOR PRICES.

32V. DC to 110V. AC KATO Converters, NEW, good to 300 watts.

115V DC to 115V. AC., 60 cycles, Motor-Generators. 500 Watts output; mfd. by Esco, and Holtzer-Cabot.

RC-163 Radio Beacon Eqpt., designed for use with SCR-508 / 608 / 528 / 628 / 510 / 610 Transmitter-Receiver, 20 to 40 mc. Complete, export-packed, NEW equipment.

TE-54A & TE-55A Cable Vulcanizing Units, AT-49/APR-4 Antennas.

Tuned Filter Chokes, 120 cps, 40 H., D.C. res. 410 ohms, with 0.177 mfd (600 w.v.) capacitor. N. Y. Transf. type T-OD-8035. New. Hermetically sealed. Dim: 5 1/4" H x 4 1/4" x 3 1/2". EACH\$2.95

Amertran Filter Chokes, type W, 0.04 Henries at 3.4 amps, 10 kv RMS test. New units. EACH\$3.95

Screw Plug Heating Elements, Chromolum SCB, Metal encased, 150 W, 110 volts. 5 1/4" long, 1 1/2" dia. New. EACH\$0.75

GE D & W Oil Fuse Cutouts, Model 9F2D2, rated 50 amps/5,000 V. or 100 amps/2,500 V. grd. Y. New Units. WRITE FOR PRICE. BD-72 Switchboards, Excellent Condition. EACH\$55.00

Dynamotor DM-28, for BC-348 Receiver. New. EACH\$7.25 MP-22A Mast Base, w/insulator spring-loaded for swiveling and quick return. New units. EACH\$4.95

T-9/APQ-2 Radio Transmitters. Noise-modulated Jamming Transmitter, using Electron-Multiplier Photocell. For Jamming certain types radar eqpt. New unused transmitters only, with Electron-Multiplier tube, less other tubes. EACH\$32.50

SB-23/GTA-2 & SB-14/GY Switchboards & Power Supply, for operation from 110V. 60 Cycles AC (with storage batteries). Each in individual metal cabinet. NEW. Price, Each Set\$300.00

Deck Entrance Insulators, bowl and flange type, 3 1/2" dia. with heavy galvanized metal flange and bell. Top bell 6 1/4" dia. x 11"; brass feed-thru rod, very high voltage insulation. Individually packed in cartons, all NEW. 12 FOR\$24.00

TS-48AP Echo Boxes. UNUSED. EACH\$20.00

SCR-584 Sector Scan Units. Unused. EACH\$9.00

QBE-3 Control Rectifiers, Type CBM-20223. Unused. EACH\$27.50

BC-689A Radio Transmitters. Unused. Less tubes. EACH\$22.50

Remote Antenna Drive RM-55, Hand-crank driven assembly, with illuminated azimuth scale, couples to any directive antenna by means of flexible drive shaft and permits remote control. NEW units, in wooden chests.

Aircraft—High Pressure Axial Flow Fans, 24-28 V. DC, capacity 200 cfm, 1/15 HP. Model 4581A2A. NEW units, packaged.

Purchasing Agents! We have thousands of oil condensers, transmitting micas, resistors, transformers, transmitting tubes, etc. Check with us for any special requirement.

EXTRA—SPECIAL!!! GE JAN 872A Rectifier Tubes, packed 25 to each carton. NEW, original cartons. 25 for \$75.00, while they last.

All Prices F.O.B. N.Y.C.

All Material Offered Subject to Prior Sale

TELEMARINE COMMUNICATIONS CO.

540 W. 27th St.
N. Y. 1, N. Y.

TEST EQUIPMENT

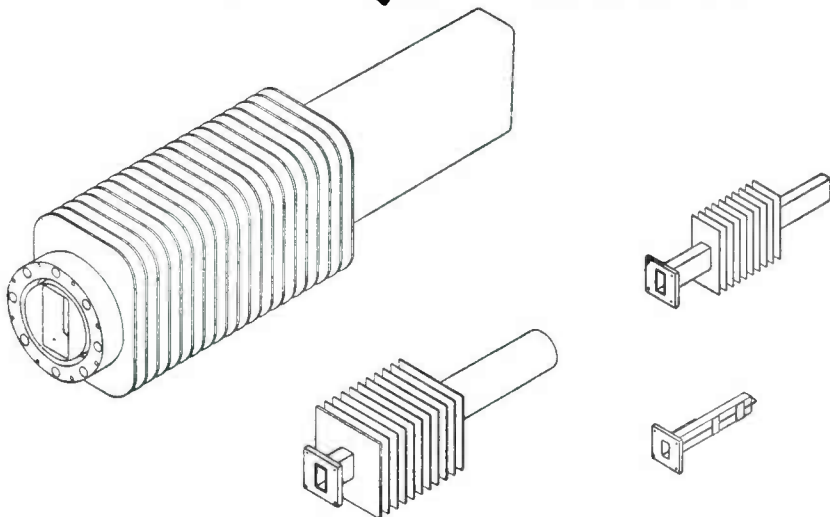

HI-POWER DUMMY LOADS

X Band, 1¼" x ½" guide, choke or plain flange, dissipates 350 watts average power continuously in still air, VSWR less than 1.15 between 7 and 10 KMC, weight 5¼ pounds.

X Band, ½" x 1" guide, choke flange, dissipates 250 Watts average power continuously in still air, VSWR less than 1.15 between 8.2 x 12.4 KMC, weight 3¼ pounds.

X Band, 1¼" x ¾" guide, plain flange, dissipates 200 watts average power continuously in still air, VSWR less than 1.15 between 7-10 KMC, weight 3¼ pounds.

X Band, 1¼" x ¾" guide, plain flange, dissipates 150 watts average power continuously in still air, weight 2 pounds 4 ounces.

S Band, 1½" x 3" guide dissipates 1,200 watts average power in still air, VSWR less than 1.15 between 2.5 to 3.7 KMC, choke flange, weight 13 pounds.

TS-30, X Band Power Meter, measures 1 milliwatt to 1 watt of X Band average power for ¾" x 1¼" wave guide.—\$200.00.

TS-155 S Band Signal Generator and Power Meter.

X Band Frequency Meter, 8,500 to 9,600 megacycles, direct reading within 25 megacycles; within 4 megacycles with correction chart. Transmission type for ¾" x 1¼" wave guide.

X Band Power and Frequency Meter for 8,500 to 9,600 megacycles measures 1 to 1,000 milliwatts average power. The frequency meter is direct reading within 25 megacycles and within 4 megacycles with correction chart; commercial equivalent of TS-230 B/AP.

TS-33/AP X Band Frequency Meter, 8,700 to 9,500 megacycles.—\$150.00.

TS-62/AP X Band Echo Box.—\$150.00.

TS-110/AP S Band Echo Box.—\$150.00.

TS-89 Voltage Divider.—\$30.00.

TS-12/AP (Unit 2) X Band slotted line with adapters and probes—\$175.00.

TS-100 Synchroscope

T-85/APT-5, 300-1,600 megacycles Noise Modulated Transmitter, 40 watts C. W.

Waveguide Below Cut-Off Attenuator L 101-A, U. H. F. Connectors at each end, calibration 30-100 db.—\$25.00.

Amplifier Strip AM-SSA/SPR-2 contains I. F. amplifier, detector, video amplifier, pulse stretcher and audio amplifier and Rectifier Power Unit PP-155A/SPR-2 band-width 10 megacycles, center frequency 30 megacycles, sensitivity 50 microvolts for 10 milliwatts output. Power supply 80/115 V ac, 60-2, 600 cps 1.3 amps. Send for schematic—\$65.00 less tubes.

Tuning Units for APR-4 Receiver

TN 16	30- 80 megacycles	TN 18	300-1,000 megacycles
TN 17	80-300 megacycles	TN 19	1,000-2,200 megacycles
		TN 54	2,200-4,000 megacycles

ELECTRO IMPULSE LABORATORY
62 White Street Red Bank 6-0404 Red Bank, N. J.

COLUMBIA ELECTRONICS LTD.

SCR 300

WALKIE-TALKIE normal range 3 miles or more depending on operating conditions. Frequency range: 40.0 to 48.0 mcs. Brand new. Complete.

HEADSETS

HS-38 & HS-33 BRAND NEW

R-4/ARR-2 RECEIVER

34-58 mcs. Brand new. COMPLETE WITH RACK AND CONTROL BOX.

AN/CRT-3

EMERGENCY RADIO TRANSMITTER. T-74/CRT-3 DUAL FREQUENCY OPERATED TRANSMITTER. Operates on both 8280 kc. and 500 kc. Power output 2½ W. on 500 kc and 2 W. on 8280 Kc. BRAND NEW. COMPLETE WITH PARACHUTE, KITES, LAMP, BALLOON and GENERATOR.

TEST EQUIPMENT

Complete Line!

Signal Generator 804-C
DuMont 224-A Oscilloscope
1-77 Hickok Tube Checker
1-208 FM Signal Generator
RPC Model 644 Multimeter
Ferris Microvolter Mod. 18-C

IE-36 (New)	TS-100/AP
I-122	TS-102A/AP
I-139 METER	TS-111/CP
I-212	TS-126
I-222	TS-127/U
TS-3/AP	TS-170/ARN-5
TS-5/AP	TS-175/UP
TS-10B/APN	TS-182/UP
TS-19/APQ-5	TS-184A/AP
TS-24A/APR-2	TS-204/AP
TS-34/AP	TS-250/APN
TS-36/AP	UPM-1
TS-61/AP	(Complete)
TS-62/AP	WE 1 193
SL-1 Slotted Line Test Set	Range Calibrator 1-146

MODULATOR UNIT BC-1203-A
With Coupling Heads BC-1201 & BC-1202

RC-184 IFF EQUIPMENT

Complete. Brand new.

APS-4 Complete Radar
Mark 16 Complete Radar
APS-6 Complete

RECEIVERS

APR-4	APR-5
SCR-720 Equipment	MG-19A New

MK-20A/UP

Brand new. Individually boxed.

SEE COLUMBIA ELECTRONICS AD
ON PAGE 382

All items subject to prior sale.

Note! We have moved to our own, larger quarters. Note new address below:

COLUMBIA ELECTRONICS LTD.

7460 N. VARNA AVENUE
NORTH HOLLYWOOD, CALIF.
Cable Address: COELECT

Specialists in Test Equipment

It is not generally known but Weston Laboratories specializes in the recreation of military electronic test equipment, many pieces of which are produced in quantity as new merchandise. One such piece is the TS-125-10CM power measuring radar test set. This self-contained, water-proof portable unit covers the range 2400-3335 MC with a sensitivity of 2 milliwatts full scale and an accuracy of + 0.5DB. Calibration is both DBM and milliwatts.

Other pieces available include:

- | | | | |
|--------------|--------------|-----------|-----------|
| TS-1ARR | TS-118/AP | I-212 | BC-1255/A |
| TS-3A/AP | TS-125/AP | I-222/A | BC-1287/A |
| TS-8A/U | TS-127/U | I-225 | BC-1277 |
| TS-10A/APN-1 | TS-131/AP | I-233 | BE-67 |
| TS-11/AP | TS-144TRC-6 | IE-21/A | LAD |
| TS-12 | TS-153 | IE-36 | LAF |
| TS-13 | TS-155A/AP | IF-12/C | LAG |
| TS-14 | TS-170/ARN-5 | IS-185 | LM13 |
| TS-15B/AP | TS-173/UR | AN-PNS-1 | LU2 |
| TS-16/APN | TS-174/U | BC-221(*) | LU3 |
| TS-19 | TS-175/U | BC-376 | OAA-2 |
| TS-23/AP | TS-184/AP | BC-638 | P4E |
| TS-27/TS | TS-197/CPM-4 | BC-906/D | TAA-16EA |
| TS-32A/TRC-1 | TS-203/AP | BC-949/A | TSS4SE |
| TS-33/AP | TS-204/AP | BC-1060/A | TSX3SE |
| TS-34/AP | TS-205/AP | BC-1066/A | TSX4SE |
| TS-34A/AP | TS-220/TSM | BC-1201/A | TTS-4BR |
| TS-35/AP | TS-226A | BC-1203 | TTX-10RH |
| TS-36/AP | TS-233/TPN-2 | BC-1236/A | TUN-9HU |
| TS-24/APM-3 | TS-251 | | |
| TS-46/AP | TS-263 | | |
| TS-47/APR | TS-268 | | |
| TS-51/APG-4 | TS-270A/UP | | |
| TS-56/AP | TS-281/TRC-7 | | |
| TS-60/U | TS-301/U | | |
| TS-61/AP | TS-314/FSM-1 | | |
| TS-62/AP | TS-323 | | |
| TS-69/AP | TS-324/U | | |
| TS-76/APM-3 | TS-389/U | | |
| TS-87/AP | TS-421/U | | |
| TS-89/AP | TS-487/U | | |
| TS-96/TPS-1 | I-56 | | |
| TS-98/AP | I-95/A | | |
| TS-100/AP | I-106/A | | |
| TS-101/AP | I-122 | | |
| TS-102/AP | I-130A | | |
| TS-108/AP | I-145 | | |
| TS-110/AP | I-177 | | |
| TS-111/CP | I-178 | | |
| TS-117/GP | I-208/A | | |



Don't forget, we buy Test Equipment too!

Cable: WESLAB

Tel. Boston: WE 5-4500

Weston Laboratories

Weston 93, Mass.

JAN-C-25 CAPACITORS

YOU NAME IT WE HAVE THEM

DELIVERY FROM STOCK . . . FACTORY CLEAN CONDITION

CHANNELS—YAB CP69 • YAT CP67 • WAB CP65 • WAT CP63
 UPRIGHT TYPES—CP40, 41 • CP61 with universal brackets • CP70 series
 BATH TUB TYPES—CP53 side term. CP54 top term. CP55 bot. terminals
 CHANNELS & BATH TUB TYPES AVAILABLE IN SINGLE, DUAL OR TRIPLE UNITS
 CAPACITY VALUES—.01-.02-.05-.1-.25-.5-1.0-2-4-6-8-10-15 MFD
 VOLTAGES AVAILABLE—50-100-200-400-600-1100-1500-2000-2500-3000 etc.
 MOST TYPES IN VERY LARGE QUANTITIES • LET US QUOTE ON YOUR REQUIREMENTS

RELAY SPECIALS				
Type	Coll	Contacts	Features	Price
Sigma #5	65(2)	SPDT	2-24 VDC	\$2.45
Sigma #5	65(2)	SPDT	CASED	3.45
Sigma #5	5000(2)	SPDT	1 1/2 ma plate	4.75
Leach 1077BF	160	DPDT	CERAMIC	2.45
G. E.	2000	SPDT	4 ma plugin	2.95
Clara SK-5032	32	DPDT	6VDC plugin	3.45
W. E. KS-9665	2000	1A, 1B, 1C	9 ma	4.25
A-B B5	100	SP solenoid	50 A 24 V	1.85

SPECIAL . . . TRANSFORMER LAMINATIONS . . . SPECIAL
 F-12 MUMETAL UI-312 . . . \$3.35 L-12 SILICON . . . \$3.5¢

ELECTRONIC SPECIALTY SUPPLY CO. 56 Lispenard St. Barclay 7-2684 New York 13, N. Y.

Westinghouse
 ELAPSED
 TIME
 METERS
\$15.50



General
 Electric
 Round Case
 Smaller
 Numerals
\$11.50

Genuine TELECHRON Motors

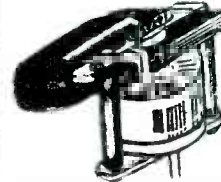

- 2 RPM \$2.90
 - 3 RPM 3.90
 - 3.6 RPM 3.15
 - 1 RPM 3.95
 - 60 RPM 4.30
- One of each \$15.00

ZENITH 1951 TV Remote Control Motor Units

Reversing control switch at end of 17 foot cable. Powerful 4 RPM clutch motor.

Will drive anything

\$1290

Can be used for door opener, window raiser, model RL turntable. Complete with transformer. 6 for \$70.00



MARKTIME
 5 HOUR SWITCH

A 10 amp. timing device. Pointer moves back to zero after time elapses. Ideal for shutting off radios and TV sets when you go to bed. Limited supply at this special PRICE. **\$4.90**

Also available in 15 min., 30 min., 1 hr. at \$5.90

- Veeder-Root Counter, Rotary \$.90
- Veeder-Root Counter, Ratchet 2.25
- No. 18 Enameled Copper Wire, 1 1/2 lb. coll. 2.00
- Solenoid, works on 24v. D.C. and 115 v. A.C. 1.50
- 4 1/2 amp. sealed 6 v. Transformer 2.75
- MU and ACRO Switches assorted 4 for 1.00
- 115 v. A.C. Motor, for fan or experiment 1.50
- Guardian, No. 4, 115 v. A.C. Solenoid 3.50
- Guardian No. 2 6 volt DC Solenoid 1.90
- Price Bros. No. 1A, 115 v. A.C. Solenoid 1.50

ALNICO **LUCKY** 17% COBALT
 PURCHASE ENABLES US TO OFFER YOU THESE *Actual Size*
MAGNETS!
39¢ EACH 3 FOR \$1.00

- Eby bakelite Binding Posts12
- TELETYPE 1/40 H.P. 110 v. D.C. Motor 2.90
- Arrow-H & H. DPDT Toggle Switch65
- C/H Off center, SPDT Toggle Switch35

ANTENNA ROTATOR or DOOR OPENER

\$750

Geared down 24v. universal motor with transformer

GE Argon Glow Lamps 4 for \$1.00
 100 for \$20.00

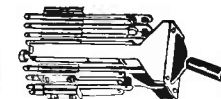

Mossman Lever Switch **\$1.50**

10 Amp. Heavy Duty Silver Contacts. Contacts can easily be restocked and changed to suit your needs. Now momentary OFF CENTER but can be changed by user to stay either side. Removed from un-used Government Surplus Equipment.

EST. 1923 **BLAN** EST. 1923
 64 Dey St. New York 7, N. Y.

Portable Instruments

Molded Bakelite case 7" x 4 1/2" x 3"

- D.C. MICROAMMETERS
 5 . . 10 . . 50 microamperes
- THERMOCOUPLE MILLIAMMETERS
 1 . 5 . . 10 milliamperes
- THERMOCOUPLE VOLTMETERS
 5 to 500 volts

Available in multiple range combinations

Precision Electrical Instrument Co.
 146 Grand Street New York 13, N. Y.



& ELECTRONICS SUPPLY

Compare These Surplus Bargains!

TEST EQUIPMENT

Now in Stock for Immediate Delivery!

TS-3	APR-1	1-144
TS-10	A-58	1-198
TS-12	A-60	1-222
TS-13	ASD or AIA	1-223
TS-16	Watt & Wave-	1E-56
TS-19	meter CS-60	LS-1
TS-34	ABW, SWR	LU
TS-45	Unit, CS-60	20A-1
TS-51	ABS Oscillo-	Triplet 1183
TS-67	scope CS-60	Tube Tester
TS-69	ABX	Espey 105 Tube
TS-74	BC-376	Tester
TS-75	BC-725	RC-252
TS-127	BC-905	LZ
TS-170	BC-906	BC-221AK
TS-202	GR-P496	BC-1016
TS-226	1-122	

WANTED—WE PAY TOP DOLLAR FOR:

All Types AIRCRAFT, RADAR, RADIO SETS, COMPONENTS, DYNAMOTORS and Associated Equipment such as ART-13's BC-611's, Test Equipment, Etc. Prompt Replies to all Inquiries!

NEW STANDARD BRAND CHOKES

SWINGING CHOKES

My	Mils	Ohms	Price	Case	Wt.
8-40	175	100	\$2.75	3KV Closed	4.5
8-30	200	80	3.25*	2KV Open	5
5-25	200	100	4.95*	2KV Closed	18
5-25	300	90	9.95*	5KV Closed	8 1/2
8-25	300	80	5.95*	5KV Open	28
5-25	500	60	12.95*	7KV Closed	58
8-40	1 amp.	50	39.95*	10KV Closed	

SMOOTHING CHOKES

My	Mils	Ohms	Price	Case	Wt.
5	500	600	4.95*	2KV Closed	4
7	150	200	1.25*	2KV Open	2
10	500	60	12.95*	7KV Closed	28
12	300	80	5.95*	5KV Closed	9
12	400	400	6.95*	2KV Closed	15
15	200	120	2.95*	3KV Open	4.5
20	300	80	5.95*	4000 Closed	9
20	400	85	6.95*	5KV Closed	14
20	300	125	12.50*	15KV Closed	40
16 Ser.	175	96	5.95*	2.5KV Closed	15
4 Par.	350	24			
26 Ser.	200	112	6.95*	3.5KV Closed	15
6.25 Par.	400	28			

BC442 ANTENNA RELAY. Contains 50 Mmfd. 5000 Volt vacuum condenser and 0 to 10 amp RF meter. With Antenna transfer switch, transmit to receive. Brand new. \$3.95*

CONDENSOR 5-5 Mfd. 400 V. DC Type KS-8976C. 3 1/2" high x 3-5/16" wide x 2" deep. Shipping wt. 2 lbs. Brand new. \$2.95*

BD77 DYNAMOTOR. 12 V. input, 1000 V. 300 MA DC output. Brand new. \$19.50*

BC348 Antenna Tuning Cond. Contains band switch and coils. Brand new. \$2.49*

CD318A CCRD for connecting Throat Mike. Has JK48, PL68 Plugs and SW141 V Switch. \$1.95*

NON-INDUCTIVE RESISTORS. IRC type MPB. 100-watt. All brand new, 1 1/2"-inches long, complete with lug terminals. Available in quantity in 95, 72 and 120 ohms. \$3.00 ea.*

RC266 RADAR ANTENNA. Part of SCR-717. Brand new, crated and ready to ship. Approx. wt. 335 lbs. \$49.50*

MO 149F INVERTOR. Brand new. \$74.00*

NEW SCR-720, 717, Components. AN/APG-13 Radar. Complete new installations. NEWLY MFG'D. 1-100 ADF Test Unit & also modification for use on AN/APN-6.

ATTENTION PURCHASING AGENTS: We have thousands of items in stock not listed here. Send us your requirements and we'll reply promptly.

EXPORT INQUIRIES INVITED

We carry an unusually large stock of Airline Equipment, Test Equipment, Radar Sets, etc. Write for our low prices and complete information. We furnish immediate answers to all inquiries. Write today!

IMPORTANT:

Send 30% deposit with all orders. All merchandise and prices subject to prior sale or change at any time.

ALL ITEMS AVAILABLE IN BIG QUANTITIES. ASK FOR GENEROUS QUANTITY DISCOUNTS!

V & H RADIO

Dept. E-12
2033-37 W. Venice Blvd.
Los Angeles 6, California

TUBE REBUILDING
Large Transmitting and Power types

Economical • Guaranteed
FREELAND PRODUCTS CO.
700 DRYADES ST., N. O., LA.

SURPLUS EQUIPMENT

POWER RHEOSTATS



Standard Brands: 5 Ohms: 100 Watt; 4.48 amps 100 Ohms; 100 Watt; 1.0 amp.

Boxed, Brand New with Knob \$2.50 each—or—\$25.00 per Doz.

G. E. MOTOR AMPLIDYNE

Mod. 5AM45DB15. Input: 115 volts, single phase, 60 cycle, 4.5 amp. Output: 250 volts DC, .6 amps, 3450 RPMs. \$79.00 ea.

PIONEER TORQUE UNITS

TYPE 12604-3-A: Contains CK5 Motor coupled to output shaft through 125:1 gear reduction train. Output shaft coupled to autodyn follow-up (AY43). Ratio of output shaft to follow-up Autodyn is 15:1 \$70.00 ea.

TYPE 12606-1-A: Same as 12604-3-A except it has a 30:1 ratio between output shaft and follow-up Autodyn. \$70.00 ea.

TYPE 12602-1-A: Same as 12606-1-A except it has base mounting type cover for motor and gear train. \$70.00 ea.

ALNICO FIELD MOTORS



(Approx. size overall . . . 3 1/2" x 1 1/4" diameter) Delco-Type 5069230: 27.5 Volts; DC; 145 RPM \$19.95 ea.

Delco-Type 5068820: 27.5 Volts; DC; 250 RPM \$19.95 ea.

PIONEER AUTOSYNS

AY-1 26 Volt—400 Cycle. \$4.95
AY-5 26 Volt—400 Cycle. \$5.95
AY27D \$25.50
AY6—26 Volt—400 cyc. \$4.95 ea.
AY30D—26 Volt—400 cyc. \$25.00 ea.
AY38D—26 volt—400 cyc., shaft extends both ends. \$19.95 ea.
AY20—26 volt—400 cyc. \$12.50 ea.

SERVO MOTOR 10047-2-A: 2 Phase; 400 Cycle; with 40-1 Reduction Gear \$10.00 ea.

WESTINGHOUSE HYDRAULIC TRANSMISSION

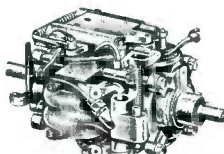

BRAND NEW Ideal as hydraulic torque converters. Contains hydraulic pump and hydraulic motor; 10 ball bearings; has reversible controls. High quality precision workmanship . . . made to exacting specifications for use on 2-ton 40 mm anti-aircraft guns. Overall dimensions: 12" long x 5 1/2" wide x 6 1/2" high. Shipping weight: 20 lbs. Government cost more than \$300. BRAND NEW \$29.95 ea.

400 CYCLE MOTORS

AIRESEARCH: 115V; 400 CPS; Single Phase; 6500 RPM; 1.4 amp; Torque 4.6 in. oz.; HP .03. \$10.00 ea.
EASTERN AIR DEVICES TYPE J46B: 280 VAC; 1 amp; 3 phase; 400 cycles; 6000 RPM. \$12.50 ea.
EASTERN AIR DEVICES, TYPE J31B: 115 V, 400-1200 Cycle, Single Phase \$12.50 ea.

INVERTERS

FE 218 LELAND ELECTRIC Output: 115 VAC; Single Phase; PF 90; 330/500 cycle; 1500 VA. INPUT: 25-28 VDC; 92 amps; 8000 RPM; Exc. Volts 27.5 BRAND NEW \$39.95 ea.
MG 163 HOLTZER-CABOT Input: 24 V. DC, 52 amps; Output: 115 volts—400 cycles, 3-phase, 750 VA, and 26 Volt—400 cycle, 250 VA. Voltage and frequency regulated. \$95.00 ea.
12116-2-A PIONEER Output: 115 VAC; 400 cyc; single phase; 45 amp. Input: 24 VDC; 5 amp. \$90.00 ea.

PLEASE ENCLOSE FULL AMOUNT WITH ORDER

TACHOMETER INDICATOR SINGLE



Sensitive Type, Kollsman Mark V; Range 0-3500 RPM in 3 1/4 revolutions of the indicating pointer. \$9.95 ea.

SMALL DC MOTORS

(Approx. size . . . 4" long x 1 1/4" dia. General Electric-Type 5BA10AJ37: 27 volts, DC; .5 amps, 8 oz. inches torque; 250 RPM; shunt wound; 4 leads; reversible \$12.50 ea.

G. E. Type 5BA10FJ215, 24 volts DC, .77 amp, 30 lbs. in. torque, 4 RPM. \$15.00 ea. General Electric-Type 5BA10AJ52C: 27 Volts, DC; .65 amp; 14 oz. inches torque; 145 RPM; shunt wound; 4 leads; reversible \$12.50 ea.

MICROPOSITIONER

Barber Colman AYLZ 2133-I Polarized D.C. Relay: Double Coil Differential sensitive; Alnico P.M. Polarized field. 24 V contacts; .5 amps; 28 V. Used for remote positioning, synchronizing, control, etc. \$12.50 ea.

TACHOMETER GENERATOR



Pioneer Instrument. Mark V, screw mount. Used with Kollsman Mark V Indicator \$25.50 ea. Tachometer Indicator and Generator (above) Both \$33.50

PIONEER GYRO FLUX GATE AMPLIFIER

Type 12076-1-A, complete with tubes \$27.50 ea.

PIONEER TORQUE UNIT AMPLIFIER

Type 12077-1-A. A single tube amplifier designed for autodyn take off signal. Contains magnetic amplifier assembly. With tube \$24.50 ea.

10563 LELAND ELECTRIC Output: 115 VAC; 400 cycle; 3-Phase; 115 VA; 75 PF. Input: 28.5 VDC; 12 amp. \$80.00 ea.

16486 LELAND ELECTRIC Output: 115 VAC; 400 Cycle; 3-phase; 175 VA; 80 PF. Input: 27.5 DC; 12.5 amp. Cont. duty \$90.00 ea.



SENSITIVE ALTIMETERS

Pioneer Part #1556-2K-A Sensitive altimeters. 0-35,000 ft. range . . . calibrated in 100's of feet. Barometric setting adjustment. No hook-up required. \$12.95 ea.

SYNCHROS

IF Special Repeater (115V-400 Cycle \$15.00 ea.
2J1F3 Generator (115V-400 cyc) \$7.50 ea.
5CT Control Transformer; 90-50 Volt; 60 Cyc. \$50.00 ea.
5F Motor (115/90 volt—60 cyc.) \$60.00 ea.
5G Generator (115/90 volt—60 cyc.) \$50.00 ea.
5SDG Differential Generator (90/90 volts—400 cyc.) \$30.00 ea.
5DG Differential Generator 90/90 volts 60 cycle \$50.00 ea.
TRANSMITTER, BENDIX C-78248; 115 Volt, 60 Cycle. \$25.00 ea.
REPEATER, BENDIX C-78410; 115 Volt, 60 Cycle \$37.50 ea.

METERS

AMMETER; DC; 2" 100-0-100, complete with external shunt. \$6.95 ea.
AC Volt, Westinghouse, Type NA-35—3-inch round. F.S.-10 MA. \$6.95 ea.
FREQUENCY, 57-63 cycles per second, 125 volts, mfg. Aero. mod. 7007. 3-inch round \$8.95 ea.

EQUIPMENT FULLY GUARANTEED

ALL PRICES F.O.B. PASADENA UNLESS OTHERWISE SPECIFIED



BOX 356-E EAST PASADENA STATION • PASADENA 8, CALIFORNIA

Harmar has the Nation's Largest Stock of Condensers . . . All Types

DID YOU KNOW—that you can use top quality metal cased condensers from HARMAR stock for nearly the same price as you are now paying for paper tubulars? And delivery is from stock! Remember . . . when you deal with Harmar you deal with principals — Harmar owns every item it offers for sale!

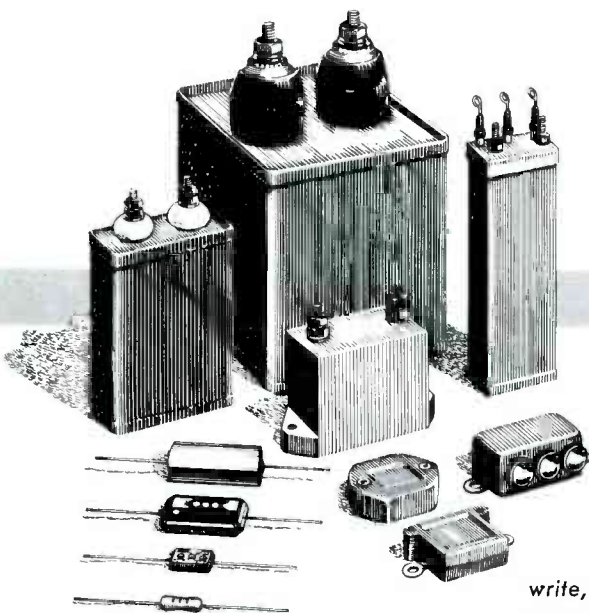

HARMAR Company

refer to our rating in Dun & Bradstreet

NOTE: We have developed special facilities for keying our stock to manufacturer's part numbers or Armed forces stock number. For quickest possible service, please request quotations by these numbers.

write, wire or phone:

242-C Territorial Rd.
Benton Harbor, Mich.

● Phone: 5-7271

1003-D Union Trust Bldg.
Cincinnati 2, Ohio

● Phone: Main 3155

Sell Your Surplus to Gould Green

We buy and sell every type of electronic materiel, including war surplus. Let us submit our bids for your surplus inventory; large or small quantities. When you buy from us you save plenty — here are a few of our bargains:—

DYNAMOTOR-DC input, 28 v. @ 1.3 A; output 240 v. @ .08 (frame 414) for RL-24A inter-phone equip. by Telephonics Corp.; with base; . . . \$3.85

COIL-TELEPHONE, induction, C-158 holding; single winding inductance not less than one measured w/iv. @ 1000 cye; resist. 100 ohms P/M 5% AC 500 V. rms. price, 15c ea., \$10.00 per M*

AUDIO TRANSFORMER; input, Class 1A; Spec TC-45 (C-280-A) .008 watts; response 400-3000; 0-250-4000 ohms; 150 ohms; 600 ohms C.T.; made by Controls Corp. size 1 3/4 sq. x 2" H.; price . . . 95c ea.; \$75 per C

PHONO-AMPLIFIER; 2-tube for hi-gain pickups; chassis only includes cord & plug, filter cond., dropping resistor, vol. contr., etc. less tubes but ready to use & mount in phono cabinet. Price. . . . \$1.35 ea., \$14.50 per Doz.

AIR TRIMMERS; screw driver adj't but can take a slip-over shaft; six capacities available; Ceramic base with brass mtg bushings; gov't surplus. APC type. Price. . . . 25c ea., \$22.00 per C

CABLE; 3-wire with spade lugs; 10 ft. long; red, blk., & yellow with overall rubber jacket (CC-343A); 10¢ ea. . . \$9.00 per C; \$8.50 per M

CABLE; 30" long, single shielded with black cotton covering & spec. plug on one end. . . \$3.00 per C

SOCKET; 2-prong batt type; laminated

Price \$3.00 per M*

TRANSFORMER; bell-ringing type; black, fully shielded; 6 ft. cord & plug (115 AC); binding post term. with thumb nuts size 2 1/2 x 2 1/2 x 3" long; output 6-8 volts. \$1.00 ea., \$9.00 per Doz.

RESISTANCE WIRE; approx. 2 1/2 ohms per ft.; nickel .020" dia. with heatproof composition covering & Dektalstent Braid in red, black, green, blue, orange, yellow, brown & twisted pairs; G.E.; price. . . . \$8.75 per 1000 ft.*

VIBRATOR, plug-in; syn. 12. V.—19 cye.; 3 1/2" H. x 2 1/2" dia.; 4-prong . . . \$20 per C*

VIBRATOR, plug-in; Syn. 12 V.—3 A.; hermetically sealed; 7-prong; No. V-6485, Oak Mfg. Co. No. SC 3H6694.2, price . . . \$17.50 per C*

VIBRATOR, plug-in; non-syn.; 100 cye-12 V.—.5 A. Input; herm. sealed; standard 4-prong base; SC-71-2292; price. . . 50c ea., \$40.00 per C

TRANSFORMER, input: WPeo No. D-162483A; 5 1/4 x 5 1/4 x 4" H.; vapor proof; potted in gray case; price \$3.00 ea.

CHOKE; navy No. NCP-4-1E-11; imp. & herm. sealed; glass-insulator terminals; gray metal case 3 1/4 x 2 3/4 x 4 1/2" H.; invert. mtd. . . \$1.75

TRANSFORMER, POWER; fila. & pl.; Pri. 100 V. @ 10,000 cycles; Hi-V. sec. 600 V-1 ma; Lo-V. sec. 0 1/4 V. @ 0.2 A.; sealed metal case 3" h. x 2 1/4" dia. UTC No. 84257; price. . . \$2.00 ea.

TELEGRAPH SET, TG-5 (A & B); new gov't surplus; complete includes key, bell, buzzer (hi-freq.); adj. sensitive relay for incoming signals (BK-7-B); canvas carrying case with strap; portable; army-green metal case (front folds down, key is attached to the front); single headphone & tone cord with PL-53 plug is inserted in jack of instrument; size 7 L. x 5 H. x 4 deep; made by Kellogg Switchboard & Supply Co. \$14.50 ea.

VARIABLE Cond.; 2-gang, super.; with both trimmers; 1/4 shaft; 1 1/2 x 1 1/2 wide x 2 1/4 long; part of shaft near cond. is 3/8" dia. \$20.00 per C*

JUMPERS, BONDING; AMP "midret" NAF No. ABJ-E2; alum. with flat perforated lugs; flex; 2" bet. etc. \$8.50 per M*

COIL FORMS, PIGTAIL, br. bakelite (looks like carbon one watt resistors); Speer; two sizes; price \$4.00 per M*

SILVER MICA & MICA CAPACITORS at attractive prices.

DRIVE SHAFTS with br. bush. for dial cord operation; 1/4" dia.; price. \$14.50 per M*

SOCKETS, LOCKTAL, molded; . . . \$22.00 per M*

SOCKETS, WAFER, bakelite; two types—7-prong, 1 1/2" bet. cts; 9-prong, miniature. 7/8" bet. cts.; either type \$26.50 per M*

TELEVISION REPLACEMENT PARTS

list of standard items (surplus from TV mfrs) mailed upon request.

CONDENSERS, tubular; .05-200 V. \$30.00 per M* .01-400 V. @ \$30.00 per M*. .0005-600 V. @ \$17.50 per M*. .02-200 V. upright metal-enclosed, oil. special @ . . . \$20.00 per M*

CERAMIC CAPACITORS; write for list of sizes, prices & free samples.*

KNOBBS; transparent, 1 1/4" dia. with spring; also, 1" dia. malog. mlded, knurled slip-on type; each \$20.00 per M*

RESISTOR, two watt; molded Micamold pigtail; 5 ohm; \$25.00 per M*; also, 4700 ohm-2 watt @ \$22.50 per M*

CHASSIS, three tube, ampl. for phono; partly assembled, has 50L6 output transf.; 3 sockets. Fltt. cond. 40-30 @ 150 V., 10-25 V.; five carbon resistors; four tubulars; no vol. contr. no cord, no tubes. \$10.00 per Doz.

TUBE CARTONS FOR SALE

OIL-CONDENSERS; 1 mfd @ 400 V., 2 mfd @ 400 V., 1 1/2 mfd @ 100 V.; size 2 1/2 x 1 1/2 x 3 1/4 high, three top terminals. 4 tapped holes for slide mount \$20.00 per C*

SEE OUR 'AD' IN JANUARY ELECTRONICS

Terms—Net cash, o/a to est. firms; MINIMUM ORDER \$25.00; FOB/NYC. If you would like to see the mds. before paying for it, specify "Privilege of Inspection" (Express only). *FREE SAMPLE.*

SELL US YOUR SURPLUS

GOULD GREEN

252 Greenwich Street, New York 7, N. Y.

FOR SALE (NEW) HEAT CONTROL AND RECORDERS

3 Wheelco Capacilog—Model #702

1—Range 0—600 Degrees C

1—Range 0—1000 Degrees C

1—Range 0—1200 Degrees C

New in original crates

Spot Delivery—No Priority

KINGS COUNTY MACHINERY EXCHANGE

408 Atlantic Ave. Brooklyn 17, N. Y.

Phone—Tr 5-5237

SPECIAL PURPOSE TUBES ALL JANS

ALL NEW & GUARANTEED		
CE1C	\$2.25	814 \$3.50
C6J	5.95	95445
P123A	7.75	95550
P127A	17.75	95755
RK72	1.50	958A65
VR105	1.40	100575
VR150	.95	161690
1B29	4.75	161929
2K25/723AB	19.75	162545
2X2	.65	162645
3A4	.85	162945
3R24	4.75	2051 1.15
6AR6	2.75	906299
10Y	.45	9003 1.25
211	.50	900465
310A	6.95	9005 1.50
446A	4.50	900645

CRYSTAL DIODES

1N21B	\$3.2	1N25A	\$2.75
1N23	1.4"	1N23B	3.75

ALLIED ELECTRONIC SALES

136 Liberty Street New York 6, New York
Telephone COrtlandt 7-4320

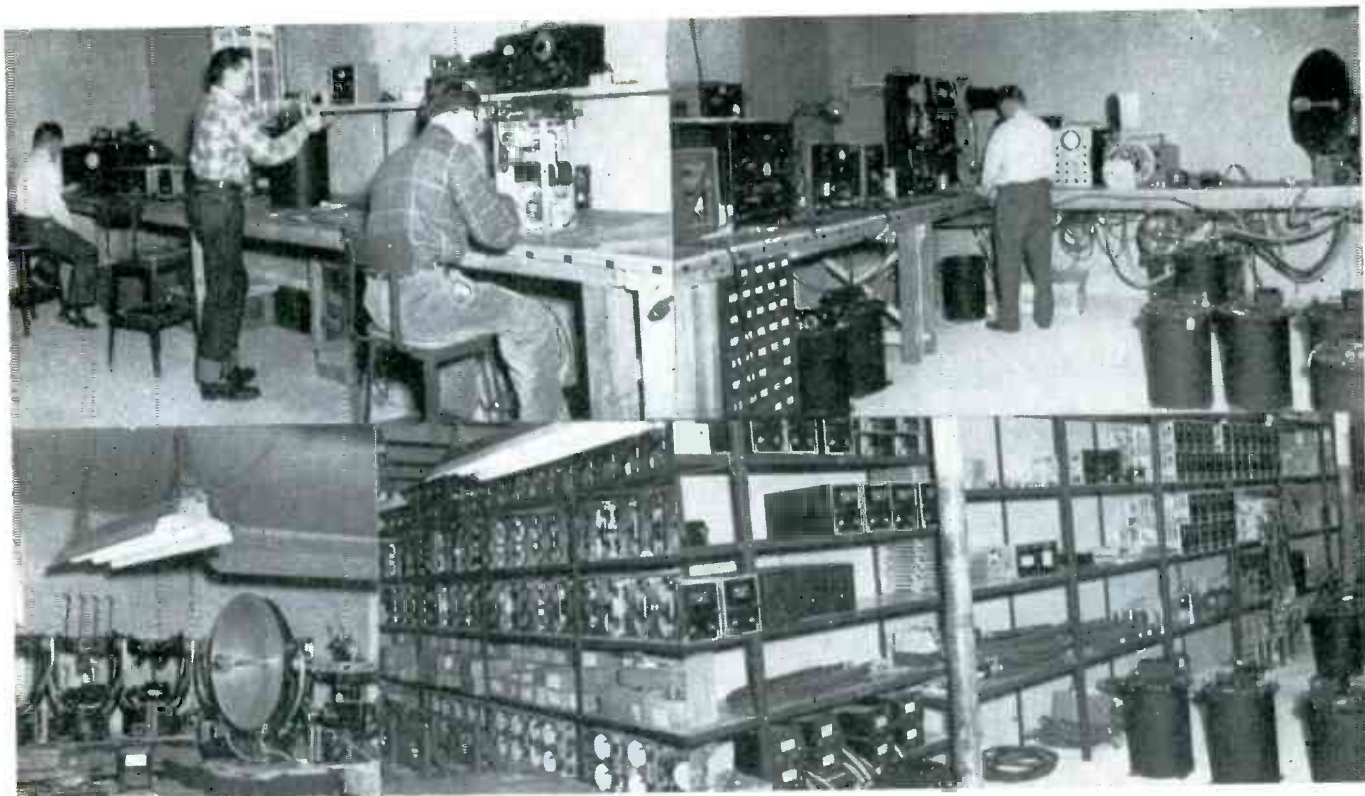

Modification, Development & Production of Radar Equipment. Radar sets SCR-717, SCR-720, APS-3, APS-4, APS-13, APS-14, APS-15 & APS-16 available. Micro-wave test equipment for all frequencies. Our personnel and facilities guarantee performance and service.

Tel.
Terhune 5-2765, 6

LERU LABORATORIES INC.

Black Oak Ridge Rd., Wayne, N. J.
Mailing Add.: RD 4, Paterson, N. J.

-CONNECTORS-

AN

"3100"

"3101"

"3102"

"3106"

"3108"

Black
and
Mellomyne
Inserts
in Stock

101 & 102

A & B

Shell Types

In Stock

Catalog On Request

CLAMP—ALL SIZES

FOR TYPES AVAILABLE SEE ELECTRONICS BUYER'S GUIDE

QUICK SERVICE OUR SPECIALTY

WILGREEN

99 Murray St., New York 7, N. Y.

For Immediate Delivery

Write or Phone - WORTH 2-7423-4-5

TELEPHONE RELAYS



Large Stock of

CLARE, TYPES C, D & E
COOKE, AUTOMATIC—ELECTRIC
ALL TYPES OF COILS and PILE-UPS

Send Us Your Specs. for Our Quote

SIGMA SENSITIVE RELAYS
Type 5RJ, Hermetically sealed coil—10,000 ohms Contacts—S.P.D.T. Closes at 0.5 Milliamps. Price.....\$5.50 ea.

CLARE TYPE C SENSITIVE TELEPHONE RELAYS				
Coil	Contacts	Will Close At	Price	
1) 6500 ohms	1C	2.8 MA	\$2.75 ea.	
2) 6500 ohms	1B-1C	3.2 MA	3.00 ea.	
3) 6500 ohms	3A	4.0 MA	3.00 ea.	
4) 6500 ohms	3A-1B	4.0 MA	3.00 ea.	
5) 6500 ohms	1C	1.5 MA	3.25 ea.	

CLARE TYPE G SENSITIVE HALF-TELEPHONE RELAYS				
Coil	Contacts	Will Close At	Price	
1) 6500 ohms	2A	5 MA	\$2.50 ea.	
2) 5800 ohms	3A	5 MA	2.50 ea.	
3) 5800 ohms	2B-1C	5 MA	2.50 ea.	
4) 4850 ohms	1C	3.5 MA	2.50 ea.	
5) 3600 ohms	1C	6 MA	2.00 ea.	

All above Relays may be used for continuous duty operation on 110V. D.C.

OTHER TYPE G RELAYS			
Coil	Contacts	Will Close At	Price
1) 1300 ohms	1A-1C	24 or 48V.	2.50 ea.
2) 700 ohms	2A-1C	24V.	2.50 ea.

Legend (A) Normally open set of contacts.
(B) Normally closed set of contacts.
(C) Single pole double throw set of contacts.
MA = Milliamps.

Chase

Electronics Supply Co.
222 Fulton St.
New York 7, N. Y.
HOLLIS 4-5033
Dgby 4-3088

American & Canadian enquiries to our Agents:

POLAS MERCANTILE

115 Broadway

New York, 6

Telephone: Rector 2-8595

ALL OTHER ENQUIRIES
TO LONDON



Leading Exporters and Stockists of all types of Radio Receiving and Transmitting Tubes. Current Production of main British Factories. Ex-Government Surplus, American, Canadian and British Tubes in Original Brands. Suppliers to Foreign Governments, Airlines, etc.

HALL ELECTRIC LTD

89, CHARLOTTE ST., LONDON, W.I.

Phones: MUSEUM, 9661 (5 lines)
Cables: HALLECTRIC, LONDON

OUR EXPORT DEPARTMENT AVAILABLE FOR SPECIAL SERVICE TO OVERSEAS CUSTOMERS

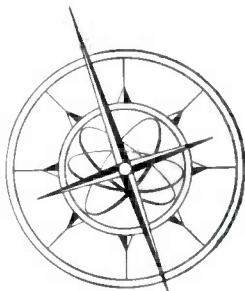

COMPASS

COMMUNICATIONS COMPANY

393 GREENWICH STREET
NEW YORK 13, N. Y.

BEekman 3-6510

CABLE ADDRESS: COMPRADIO

WE MAINTAIN OUR OWN FULLY EQUIPPED TESTING LABORATORY IN THE SAME BUILDING AS OUR MAIN WAREHOUSE TO TEST ANY ITEM WE SELL

• **RADAR**

MARINE, GROUND & AIRBORNE

AN/APS-2	SA-2	SF
APS-3	SL	SG
APS-4	SN	SL
APS-6		SCR-345
APS-13	SO	SCR-729
APS-18	SQ	
	SJ	

• **BEACONS**

AN/CPN-6-3 om.
AN/CPN-8-10 om.
YJ and YG for shipboard use

• **LORAN**

AN/APN-4 and AN/APN-3

• **TELEPHONE EQUIPMENT**

Portable and Stationary Switchboards and Supplies
BD-71, six-line portable switchboard
BD-72, twelve-line portable switchboard

• **CONVERSION EQUIPMENT**

- MOTOR GENERATORS
- CONVERTORS
- DYNAMOTORS
- INVERTORS
- POWER SUPPLIES
- RECTIFIERS

• **TEST EQUIPMENT**

SELECTED EQUIPMENT

TCS—Collins mfd. Navy radiotelephones for shipboard and mobile use, complete with all accessories for operation from 12, 24, 110, 230 volts d.c. and 110 or 220 volts a.c.
TDE—Navy or commercial marine transmitters, complete, 110 & 220 volts d.c. and a.c.
TEK—Navy high frequency transmitter, 3-20 mc; 500 watts output. Supplied complete with m/s and starter for d.c. or a.c. operation.
TBL—Navy all-wave transmitter; 350 watts output; CW and phone. Supplied complete with m/g and starter for d.c. or a.c. operation.
TAJ—Navy intermediate freq. transmitter, 175-560 kcs; 500 watts output. Supplied complete with m/g and starter for a.c. or d.c. operation.
SCR-284—the famous mobile and ground station for field use. Large quantity of complete sets available.
MAG—10 cm. portable link radar transmitter receivers. 6-volt operation.

TRANSMITTING STATIONS

1 KW—200-500 kcs, complete with 220/440 volt, 3 ph. 50-60c. power supply—Price \$2,500.
800W—(400 watt phone) Western Electric 10-channel, automatic dial selection, 2.0-20.0 mcs, with 220 volt, 1 ph, 50-60c. power supply, SAME TRANSMITTER AS USED ON S.S. "QUEEN MARY"
—Brand New. Price \$4,000.00.
1 KW—FM Broadcast station, complete with monitor, all tubes, antenna and waveguide, Mfr. G. E. \$1,500.00—at location, N. Y. C.

★ All equipment new or reconditioned, checked in our laboratory and ready for operation.

• **TUBES**

New, Standard Brands Only

- MAGNETRONS
- KLYSTRONS
- TRANSMITTING

and other Special Purpose Tubes

This is a sample listing. Write for prices.

707B.....	\$17.50	204TL.....	\$13.00
723A/B.....	24.00	2J26.....	25.00
2K25.....	37.50	2J27.....	25.00
2K26.....	150.00	2J31.....	25.00
2K28.....	35.00	2J32.....	47.50
2K29.....	27.50	2J36.....	100.00
2K41.....	95.00	2J38.....	40.00
2K45.....	150.00	2J39.....	40.00
2K54.....	150.00	2J42.....	135.00
2K55.....	150.00	2J50.....	75.00
707B.....	25.00	2J61.....	75.00
715C.....	32.50	2J62.....	75.00
724B.....	5.00	4J52.....	335.00
829B.....	15.00	5J23.....	25.00
304TH.....	13.00	5J26.....	400.00

Special: 889R.....\$195.00
892R.....195.00

CATHODE-RAY TUBES

5BP1.....	\$6.00
5CP1.....	6.00
7B P7.....	6.00
12DP7A.....	39.50

WE GUARANTEE EVERYTHING WE SELL

26 CONDUCTOR CABLE made up by Western Electric in 50 foot lengths with S324CCT connectors on each end. Each conductor is #22 standard and rubber covered. Although the O.D. is only 9/16 inches there is a heavy live rubber jacket. Per length, only.....\$9.95



25 WATT POTENTIOMETERS

Ohm	Bush	Shaft	Cat #	Price
2	5/8s	1/8sd	O-H	\$1.04
3-3	1/2	1/2	C	1.04
15	3/8	1-1/8	D-245	1.04
15	1/2	1-1/4	I	1.04
20	1/2	1/2F	D-245	1.04
25	3/8	1	D-245	1.04
30	3/8	1	C	1.04
50	3/8	1-1/8	D-245	1.04
50	5/8	1/8sd	O-H	1.04
75	1/2	7/16	O-H	1.04
100	3/8	1	D-245	1.04
350	3/8	1-1/8	O-H	1.04
500	3/8	11/16	D-245	1.04
4K	1-2	1/2	O-H	1.17
3K	3/8	1-3/16	D-245	2.00
5K	1/2	1/8sd	I	1.24
5K	3/8	7/8f	D-245	1.24
20K	1/2	1/8sd	D-245	1.40

These excellent wirewound controls are manufactured by the leading companies and are in the original cartons. Priced ridiculously low, only 20% of list. SATISFACTION GUAR.

50 & 100 WATT POTENTIOMETERS

Ohm	Watt	Cat. #	Price
75	100	O-K	\$2.19
500	50	O-J	1.41
500	50	O-K	1.41
500	100	O-K	2.19
800	50	O-J	1.48
1.5K	100	O-K	2.34
2.5K	50	O-J	1.48
5K	50	O-J	1.58

WIREWOUND POTENTIOMETERS

Leading Ohm	Brush	Shaft	Clean Cat	New Watt
10	3/8	1-5/8	I	2
10	3/8	2	C	2
20	1/2s	1/8sd	CTS	4
20	3/8	3/8	M	4
20	3/8	1-1/4	CTS	4
50	3/8	3/8sd	M	4
100	5/8	3/8f	I	4
100	3/8	5/16	CTS	4
200	3/8	7/8	CTS	4
200	5/8s	1/8sd	CTS	4
200	3/8	2-1/16	CTS	4
255	1/2s	1/8sd	CTS	2
350	3/8	1-1/8	I	2
350	3/8	1/2	CTS	2
400	3/8	1-1/4sd	CTS	4
750	3/8	1/8sd	CTS	4
1K	3/8	3/8	I	2
1K	3/8	3/8	CTS	2
1K	3/8	3/8sd	CTS	4
2K	1/4	1/8	CTS	2
2K	1/2s	5/16sd	CTS	2
2K	1/2	1-1/16	CTS	4
2K	1/2	1-1/2	TRF	4
3K	3/8	1/2	CTS	4
3K	3/8	1-1/2f	C	4
5K	3/8	7/16sd	CTS	2
5K	1/2	1/2sd	TRF	4
5K	1/2	1-7/8	CTS	4
5K	7/16	1-7/16	C	4
7.5K	1/2	3/8	CTS	4
10K	3/8	1/2sd	CTS	2
10K	3/8	3/8f	I	2
15K	3/8	1/2sd	CTS	4
20K	5/8	3-3/16	CTS	4
20K	5/8	5/8	CTS	4

ONLY 45¢ ea

REVERSIBLE REMOTE CONTROL DRIVE

A.C. motor driven unit designed for "lazy man" control of 1951 Zenith TV. Operates from 115 volts 60 cycle; but self incorporated transformer permits low voltage control leads. Includes attractive plastic hand grip switch with black & white control buttons. One for each direction. Motor drives worm gear which is moved against a nylon gear by solenoid. Made this way so that TV set could be tuned manually. Output to 1/4 inch shaft is approximately 4 1/2 RPM. Intermittent duty. Includes 17 feet three wire control cable with plug. Brand New. ACT NOW! Our limited supply going fast at\$10.95

COAXIAL CONNECTORS

Type	Price
UG9/U	\$1.20
UG10/U	1.20
UG12/U	1.20
UG18B/U	1.95
UG21/U	1.20
UG22/U	1.30
UG23/U	1.50
UG24/U	1.30
UG25/U	1.25
UG27/U	1.30
UG29/U	2.15
UG30/U	2.50
UG58/U	.80
UG85/U	2.25
UG87/U	1.50
UG88/U	1.50
UG97/U	4.00
UG97A/U	4.20
UG98/U	2.25
UG104/U	1.80
UG105/U	1.50
UG106/U	.10
UG107/U	3.50
UG131/U	4.50
UG167/U	2.00
UG173/U	.43
UG175/U	.17
UG176/U	.17
J-201	4.50
UG203/U	.85
UG224/U	1.45
SC-239	.40
SO239/Y	.60
UG245/U	2.95
UG255/U	2.25
PL258	.95
PL259A	.55
FL259	.60
UG260/U	1.50
UG267/U	1.50
UG274/U	4.50
FL274	1.35
UG275/U	4.50
UG290/U	1.80
UG296/U	3.75
UG306/U	3.50
UG335/U	3.75
UG342/U	2.25
M359	.35
49547	1.20
UG422/U	3.25



AN CONNECTORS COMPLETE STOCKS. SEE JANUARY ELECTRONICS FOR FULL LISTING WITH PRICES.

TURRET SOCKETS SAVE TIME BETTER CIRCUIT

Socket	Height	Stock	Price
Octal	2 1/2"	10-0-9T	5.59
Octal	2	8-0-9T	.54
Octal	3 1/2"	6-0-9T	.73
Min.	2"	12-MB-12	.63
Min.	1 1/2"	6-M-6T	.60
Min.	1"	4-M-6T	.59
Noval	3"	12-NB-12	.78
Noval	2"	8-N-9T	.66
Noval	1 1/2"	6-M-6T	.63
Noval	1"	4-N-6T	.63

DO'S Speed Delivery

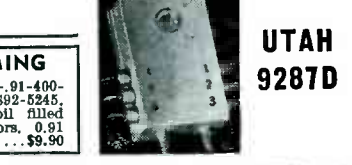

UTAH 928TD

PULSE FORMING

DELAY LINE 15-E4-91-400-50P. Sprague #S92-5245. H623, 4x5x7 inch oil filled with 3 1/2 inch insulators. 0.91 Microsecond, 15KV\$9.50

VITAMIN Q TUBULAR CONDENSERS

Cat. No.	Mfd.	Volt	Qu.	Price
774-606A*	.0033	600	231	5.95
G191P10391	.01	100	60	1.50
G191P10392	.01	2	250	1.50
G88P10394	.01	400	180	1.65
G491P22391	.022	100	20	1.65
G491P68352	.068	200	454	1.65
G91P82394	.082	400	48	1.65
G91P15491T	.15	100	199	1.65
G191P22491T	.22	100	49	1.65
G491P27491	.27	100	23	1.65
G491P4791	.47	100	140	1.75
G91P56492	.56	200	28	1.75
G91P68492	.68	200	30	2.19
G91P10592	1	200	78	2.20
XFC 1489*	1	600	20	2.20

*not Vitamin Q but similar. THESE ULTRA HIGH QUALITY CONDENSERS ARE MADE BY LEADING MANUFACTURERS.

- 20,000 Megohm or More
- Subminiature
- Glass Seal Terminals
- Up to \$7.70 regular



Widely Known for Fair Dealing and Good Service

HAROLD H. POWELL
2104 MARKET STREET
PHILADELPHIA 3, PENNA.
PHONE LOcust 7-5285

SELENIUM RECTIFIER — Full wave bridge, G.E. model 6R5FB3, up to 54 V. AC, 150 Mill. Cont. Duty, 12-1" plates 1500 ea. available.

DRIERITE — THE VERSATILE INDICATING DESICCANT—size #8 mesh in 6 oz. bottles, 24 bottles to a case. In case lots \$4.80 per case, minimum order 6 bottles for\$1.50

Eastern Air Device J50E Dual Centrifugal Blower, 115 volt 60 cycles 0.1 amp. 1 PH 20 C.F.M. Continuous duty 1.0 M.F.D. Capacitor start with Capacitor\$18.25

Miniature lamp T1 1/4, 3 volt .19 amp. Airplane Indicator, Amb. Ctd. 10 for\$1.00
100 for\$8.50

A5 Automatic pilot Directional Gyro made by SPERRY'S Part # 656029.

AMMETER, 150/300 dual range Triplet 341A 3 1/2" rectangular flush bakelite 5 amp Movement @ \$4.95 with external current transformer for 150 amp. Only \$7.50

Square D Circuit Breakers Push Type AN3161-35 35 amp. @ 30 volt D.C. \$1.15 each

Square D Bat Handle Circuit Breaker. Type AN3160-15 30 volt @ 15 amp. \$1.25 each

SEND FOR FREE BULLETIN
Digby 9-2188-9
A. Cottone & Company
Electronic Mechanical & Optical Components
336-340 CANAL ST., NEW YORK 13, N. Y.
ALL PRICES F.O.B. N. Y. CITY

COMPONENTS • TUBES • UNITS

1A5gt.	.65	3DP1-S2.	3.95
1B22	2.75	3HP7	2.95
1B24 Syl	12.95	4L7	4.65
1C6	.45	307A	2.95
1G6gt	.57	310A	5.25
1H5gt	.65	311A	5.95
1J6C	.75	394A	3.95
1LH4	.89	5BP1	4.95
1LN5	.75	5D11	14.00
1N5gt	.72	5F7	1.65
1L4	.55	5T4	1.50
1R4	.55	5U4G	.55
1R5	.72	5Y3G	.49
1T4	.77	5Y3GT	.49
2AP1	.60	6AG7	.60
2C26A	.17	6AC7	.75
2E22	1.95	6AG7	1.55
2J22	4.50	6C5	.60
2J31	17.50	6C6	.39
2J32	27.50	6C8G	.59
2K41	67.50	6E6	.75
2H-VT4C	.49	6H6	.59
3AP1	10.00	6HGt.	.73
3BP1	4.95	6J5gt	.55
3B26	2.75	6K7	.70
3B27	2.75	6K8G	.70
3DP1	2.95	6K8gt.	.75

INDUSTRIAL PILLAR INSULATORS
Glazed ceramic with heavy metal mounting base. Ideal for high voltage & high freq. applications.
Height overall Pillar Dia. Price ea.
3" 1" .45
4" 1 1/2" .65
5" 1 1/2" .95 metal cap
6" 1 1/2" .75
8" 1 1/2" .85
Eee-hive white ceramic.
1 1/2" 2" .21 6 for \$1.00

POWER TRANSFORMERS
Thord. #T-51378 TV. Power, etc. H.V. ct. 410-0-410 V. @ 325 Ma. \$6.75
Fil. #1. 6-3 V. @ 12.5 Amp.
Fil. #2. 6-3 V. @ 4 Amp.
Fil. #3. 5 V. @ 2 Amp.
Flush mtg. completely shielded. New \$8.75

BC-312 POWER TRANSFORMER
Sym. C-228 C.T.C. 110-220 V. 60 cyc Prim. 700 V. Ct. @ 100 Ma. 5 3A. 12.5 V. 2A. & 12.5 V. @ 3A. Open Frame. New \$6.75

HIGH FREQUENCY COAXIAL CABLE
A water proof fabric covered double shielded low loss cable developed by Bell Labs. All lengths have PL-250 male connectors on each end. Electrical characteristics: Impedance at 1Mc.—65 ohms min., 75 ohms max., Attenuation at 1Mc. = .6db. per 100 ft. Capacity per ft. 22 puf. (approx.). Voltage rating: 6,000 A.C. Available in 24', 36 1/2' and 60' lengths. New—8 1/2¢ per ft.
Material subject to prior sale. 25% dep. with all orders. Bal. C.O.D. Orders received less postage, shipped express. Minimum tube order \$15.00; minimum general order \$3.00.

6L6G.	1.50	807	1.35
6L6GA	1.55	81	3.75
6L7	.93	830B	2.95
6L7G.	.85	866A	1.35
6R7gt.	.83	923.	.90
6SC7	.90	954.	.19
6SF5	.65	955.	.35
6SH7	.75	10Y	.35
6SL7gt.	.65	19	.35
6SN7gt.	.70	35/51	.35
6SQ7	.65	39/44.	.29
6V6	1.65	VT-52.	.45
6V6Y	1.95	1616.	.75
6V6gt.	.65	1619.	.45
6X5gt.	.49	1642.	.40
6Y6G	.65	REL-21	2.00
7BP7	6.25	12SG7	.85
7C5	.75	12SL7	.65
7E7	.75	CK1005	.55
7E7gt.	.70	CK1006	2.25
707B	11.00	HY65	2.95
714AY	4.50	VT158	135.00
720BY	45.00	VR105	.90
723A/B.	9.50	VR150	.85
735A	6.50	2051	.95
801A	.45	802B	1.00
		24G	1.45

FREQUENCY METER—LM 14
A compact version of the famous BC-221. Built-in modulation, voltage regulation and variable output control. With original tubes, dial, Cal book and Manual. New—\$134.50



T-19/ARC 5 TRANSMITTER
3 to 4 Mc. complete with tubes & crystal. White sheet metal case. New \$24.50

VINYL TUBING—Black 5/16" I.D. x 7/8" Wall. Fresh stock. 40 ft. lengths. Per 1000 ft.\$9.85

RUBBER TUBING—5/16" I.D. x 7/8" Wall. New 80 ft. lengths. Per 1000 ft.\$9.95
V.H.F. TRANSMITTER & RECEIVER—BC-800. Range: 160-180 Mc. Rec.: 2-958 R.F. 958 Mxr. 955 Osc. 5-6AC7 I.F. (30 Mc.). 6H6 Det. Lim. 6AC7 Vid. 6V8 Video Amp. Trans. 6SN7 Mod. Amp., 2026 OSC. Pur. Sup. 2x2 H.V. & 5U4 LV. 80-115V @ 400

BRAND NEW STANDARD BRAND TUBES

OA2..... 1.45	1J6G..... .69	2X2..... .59	12A6..... .79	217C..... 8.75	715A..... 5.95	864..... .75	8025A..... 7.95
OA3/VR75 1.47	1J6GT..... .69	3B7/1291.. .59	12A7..... .89	250R..... 8.95	715B..... 9.50	865..... 1.25	9001..... 1.50
OB2..... 1.49	1LAGT..... .65	3B92..... 2.69	12F5GT..... .69	250TH..... 20.95	715C..... 24.10	866A..... 1.35	9002..... 1.25
OB3/VR90 1.19	1LA4..... .89	3B94..... 5.25	13H6..... .79	250TL..... 18.95	721A..... 4.95	869B..... 39.50	9003..... 1.75
OC3/VR105 1.25	1P5GA..... .69	3B96..... 3.50	12J7GT..... .89	257B..... 14.95	722A..... 2.39	872A..... 3.95	9004..... .75
OD3/VR150 .89	1R4/1294.. .89	3C24..... 1.75	12K8..... .89	285A..... 10.95	723AB..... 17.95	874..... 1.25	9005..... 1.75
C1A..... 9.75	1T4..... .69	3C28..... 4.95	12Z3..... .79	286A..... 18.95	724B..... 3.25	876..... .59	9006..... .29
1A3..... 1.10	1T5GT..... .89	3D6/1299.. .59	19..... .39	304TH..... 10.95	725A..... 6.25	879..... 1.43	C5B..... 3.75
1A4P..... .69	2A4G..... .89	3D3..... 4.75	20..... .89	304TL..... 10.95	730A..... 20.95	931A..... 5.95	C6A..... 5.75
1A6..... 1.25	2A6..... .59	3E99..... 13.95	22..... .89	307A..... 3.95	800..... 1.95	954..... .35	
1B4P..... .79	2A7..... .59	3Q4..... .69	24G..... 1.75	310A..... 6.50	801A..... .75	955..... .45	CATHODE RAY TUBES
1B5/235... .89	2C21/1642 .65	4B88..... 4.45	25AC5..... 1.19	316A..... 1.39	803..... 4.95	956..... .69	
1B7GT..... .89	2C22/7193 .30	4E37/257B 14.95	34..... .59	329A..... 8.95	805GE..... 4.95	957..... .45	3CP1/S1..... 1.95
1B92..... 6.95	2C26..... .39	4J82..... 139.50	35/51..... .79	331A..... 8.95	808..... 2.95	CK1005..... .75	3DP1..... 4.75
1B96..... 2.75	2C26A..... .39	4J86..... 159.75	36..... .50	371B..... .89	809..... 2.39	CK1006..... 3.49	3FP7..... 1.85
1B97..... 18.75	2C34/RK34 .59	4J42/700A 24.95	37..... .49	388A..... 1.49	810..... 12.75	E1148..... .33	4AP10..... 4.50
1B99..... 4.75	2C40..... 9.95	5C30/C5B.. 3.75	38..... .75	417A..... 8.49	811..... 3.25	E1608..... 4.95	5AP1..... 3.49
1B36..... 14.75	2C44..... 1.00	C6A..... 5.75	39/44..... .49	450TH..... 44.50	812..... 3.25	E1613..... .89	5FP7..... 3.95
1B56..... 34.95	2E5..... .89	6A3..... 1.25	45 Spec/VT52 .29	530..... .79	813..... 16.95	E1616..... .89	7BP5..... 18.95
EL1C..... 2.69	2E22..... 2.95	6AC3GT..... .89	46..... .79	531..... .69	814..... 6.75	E1619..... 3.75	10B4..... 17.95
1C6..... .69	2E24..... 4.85	6AK5..... 1.35	49..... .69	533..... .89	815..... 75.00	E1624..... 2.89	12LP4..... 20.95
1C7G..... .79	2E26..... 3.49	6CBG..... .79	EP50..... .79	CFP72..... 1.25	559..... 3.95	E1625..... 11.95	12LP4A..... 22.25
1D5GP..... .79	2J22..... 7.50	6DB8..... .59	CRP72..... 1.25	EP71..... 5.95	HY615..... .22	E1626..... 10.95	14BP4..... 26.50
1D7G..... .79	2J27..... 24.50	6K7G..... .89	RK72..... 1.25	700A..... 24.95	829B..... 14.95	E1629..... 3.25	16DP4A..... 34.00
1D8GA..... .79	2J27..... 24.50	6L7G..... .89	CRP73..... 1.25	701A..... 4.95	830B..... 3.25	E1636..... 2.95	16RP4..... 35.00
1E5GP..... .89	2J30..... 69.50	6R7G..... .99	RK73..... 1.25	702A..... 3.19	832A..... 9.50	E1642..... .98	17BP4A..... 35.00
1E7GT..... .89	2J31..... 24.50	6S7G..... .79	RELS..... 75.00	703A..... 5.75	833A..... 48.75	E1651..... 1.69	19AP4A..... 61.25
1F4..... .59	2J32..... 37.50	6SA7GT..... .69	FG81A..... 3.50	704A..... .95	836..... 4.75	E1651..... 1.09	19AP4B..... 61.25
1F5G..... .69	2J33..... 37.50	6SR7GT..... .79	VT90..... .98	705A..... 2.75	837..... 2.49	E1693..... 3.95	20CP4..... 49.95
1F6..... .79	2J40..... 37.50	6T7G..... .59	VT98..... 75.00	707AY-GY 44.50	838..... 3.95	E1793..... .25	
1G4GT..... .79	2J61..... 47.50	6ZY5G..... .79	100TH..... 7.95	707A..... 9.15	843..... .25	E8001..... 14.95	TUNGAR BULBS
1G5G..... .79	2J62..... 47.50	7C4..... .69	HY114B..... .75	707B..... 17.25	846..... 49.95	E8011..... .75	6 Amp. Rectigon Westinghouse 4.75
1G6GT..... .69	2K25/723AB .79	7E5..... .89	VT127..... 2.50	710A/8011 .75	851..... 48.75	E8012..... 2.75	
1H4G..... .79	2V3G..... .98	7E6..... .79	205B..... 3.95	713A..... .98	860..... 6.50	E8013A..... 4.75	
1H6G..... .69		10Y..... .75	211..... 1.75	714AY..... 5.75	861..... 23.95	E8020..... 1.25	

MARITIME INTERNATIONAL COMPANY

11 State Street, New York 4, N. Y. Cable Address "Foxcroft" Phones: Dlgby 4-3192-3

DEPENDABILITY IN ELECTRONICS

Attn: Industrial Purchasing Agents . . .

Our new Radio Master Catalogue is available to you at no charge upon receipt of your request on your letterhead. We are National Distributors of General Electric, Sylvania, Ohmite, Amphenol, Sprague, Aerovox, Sangamo, Stancor, Merit, A. H. & H., Simpson and many others. All telegrams, cablegrams, and inquiries acknowledged and promptly answered.

NORMAN RADIO DISTRIBUTORS INC.
94-29 MERRICK BOULEVARD JAMACIA, N.Y. - REpublic 9-4651

TIME DELAY

RELAY, 115v, 60cy adjustable 10 sec. to 2 minutes Cramer TD2-120S. Also TD80S 10 to 60 sec. \$12.95
MOBILE XMTR, LINK 25UFM w/6v dynamotor & tubes, 30-42mc 15KC FM 9x17x8 1/4" H. Used, excellent. \$59.50
SYNCHRO MOTOR IF SPECIAL 115/00v 400cy \$11.95
BLOWER MOTOR 400-1800cy 115v. EAD J31C \$9.95
BATHTUB COND. .5-400vdc side term. 100 for \$29.00
RELAY 3PDT 24vdc 250 ohm Clare Type K. \$1.55
FIL. XFRMR 6.3@1.3A (other sizes avail) .99
SILVER CER. TRIMMER TS2A 1.5-7, 7-45, 3-12 &c \$1.95
AN3106-10S-2S, PL-259AJAN, PL-68, JK33434, 83-III OIL COND, CP65, 87, 69, 70, 50, 52 BATH-TUBS, MICAS SPARE PARTS FOR: AN/TRC-1, AN/TPN-2, BC/1236A, BO-AO-83, 80134, & mate. JPOTS, FLEX. CER. COUPLINGS, XFRMRS, CHOKES, SWITCHES, & 12 vdc relays, MIKES, etc.
INQUIRIES WELCOME
EMPIRE ELECTRONICS CO.
Box 41, Midwood Station Brooklyn 30, N. Y. Cloverdale 2-2411, Bryant 9-1220, 1221

SAVE ON TUBES BRAND NEW TUBES GUARANTEED TUBES

OA2..... \$1.50	2C40..... \$16.00	4C22/HF100. 9.95	5J23..... \$59.50	6SUTGTY..... \$2.95	446B..... \$3.50	807..... \$1.59	959..... \$4.49
OA3/VR75 1.35	2C43..... 24.50	4C27/CV92. 55.95	5J26..... 59.50	RK47..... 4.95	450TH..... 30.00	808..... 2.25	991/NE16 .39
OA4G..... 1.49	2C51..... 5.95	4C35..... 34.00	5RAGY..... 2.25	RK48A..... 8.95	464A..... 4.95	809..... 7.50	1016..... .90
OB2..... 1.58	2E30..... 1.89	4E27..... 16.50	6ANS..... 5.50	EF50..... .95	WL530..... 7.50	810..... 9.50	1619..... .39
OB3/VR90 1.20	2J22..... 7.95	4J21..... 149.50	6A56..... 3.30	RKR72..... 1.25	700A/B/D 16.50	811..... 2.75	1624..... 1.50
OC3/VR105 1.35	2J26..... 19.95	4J22..... 149.50	6C5..... .79	RKR73..... 1.25	702A..... 4.95	813..... 8.50	1625..... .45
OD3/VR150 1.00	2J27..... 19.95	4J23..... 149.50	6C21..... 17.50	VT127A..... 4.95	703A..... 1.95	829..... 9.95	1629..... .39
VS-2..... 8.50	2J31..... 29.50	4J26..... 149.50	6F4..... 4.95	VT158..... 11.95	705A..... 29.50	829B..... 12.50	1632..... .89
1B22..... 3.25	2J32..... 29.50	4J27..... 149.50	6F8G..... 1.15	201C..... 10.95	706BY..... 29.50	832..... 5.50	2051..... 1.75
1B23..... 8.95	2J33..... 29.50	4J28..... 149.50	6JA..... 6.50	203A..... 5.95	706CY..... 47.50	832A..... 9.95	5611..... 1.50
1B24..... 8.50	2J34..... 29.50	4J29..... 159.50	6K4..... 4.40	211..... .75	706FY..... 47.50	833A..... 43.50	5647..... 4.50
1B27..... 17.95	2J36..... 89.50	4J30..... 249.50			707B..... 14.95	836..... 3.75	5651..... 3.30
1B32..... 3.75	2J40..... 27.50	4J31..... 89.50			707C..... 3.95	837..... 1.49	5654..... 4.50
1B35..... 12.50	2J48..... 22.95	4J32..... 89.50			708A..... .95	838..... 2.95	5676..... 5.00
1B38..... 29.95	2J56..... 169.50	4J33..... 89.50			713A..... 5.00	845..... 3.95	5676..... 3.35
1B42..... 12.50	2J62..... 32.95	4J34..... 89.50			714AY..... 8.95	851..... 39.50	5702..... 6.50
1B22..... 1.25	2K22..... 4J52..... 299.50				715B..... 22.50	852..... 19.95	5744..... 6.00
1N22..... 1.49	2K25..... 29.95	4J52..... 299.50	7B4..... 5.79	217C..... 57.75	717A..... 1.39	860..... 3.95	5751..... 5.00
1N23A..... 2.75	2K28..... 33.95	4X150A..... 35.00	7BP7..... 5.95	250R..... 8.95	721A..... 1.95	872A..... 2.75	5814..... 4.50
1N23B..... 4.50	2K39..... 99.50	4X500A..... 85.00	7C23..... 65.00	304TH..... 9.95	722A..... 1.95	874..... .69	8005..... 4.95
1N38..... 1.50	3AP1..... 9.95	5BP1..... 3.95	7V7..... .89	304TL..... 3.95	723A/B..... 14.50	878..... 2.75	8025..... 4.95
1N43..... 1.40	3B24..... 4.50	5BP4..... 3.95	9LP7..... 6.95	307A..... 4.95	724B..... 2.75	884..... 5.50	9001..... 1.75
1N54..... .29	3B26..... 3.50	5CP1..... 3.95	10Y..... .49	316A..... .59	725A..... 5.50	921..... 1.00	9002..... 1.50
1N55..... 2.75	3C22..... 64.50	5D21..... 1.95	12DP7..... 22.50	327A..... 6.95	726A..... 24.95	927..... 1.50	9003..... 1.75
1N56..... .39	3C23..... 9.95	5FP7..... 1.95	12A6..... .69	327A..... 4.50	726C..... 59.50	931A..... 3.75	9004..... .49
1N60..... .60	3C24..... 1.75	5FP14..... 4.95	15E..... 16.95	350A..... 6.95	726B..... 24.95	935..... 1.75	9005..... 1.50
1P42..... 5.50	3C33..... 13.50	5GP1..... 4.95	15R..... .45	388A..... 4.95	726C..... 3.75	955..... .49	9006..... 1.75
2AP1..... 9.95	3C45..... 16.50	5JP1..... 19.95	28D7..... 1.59	417A..... 8.50	803..... 3.75	956..... .49	9005..... 1.50
2C39..... 28.50	3E29..... 14.50	5JP5..... 19.95	32L7GT..... .99	446A..... 1.25	805..... 3.75	956..... .49	9005..... 1.50

All Prices F.O.B. Los Angeles, subject to change without notice. Minimum order \$3.00.

J. S. H. SALES CO.
Dept. E-9, 7552 Melrose Ave.
Los Angeles 46, California

1000's of other types in stock. Send us your requirements.

Special: VACUUM CAPACITORS
12-20, \$6.50 12-32, \$9.50 50-32, \$12.50

Special! RCA AUDIO CHANALYST
Type 170-A..... \$195.00

GRAPHIC RECORDING INSTRUMENTS

A. C. VOLTMETER, for 440 VOLT Systems, Range of 360 to 520 Volts, Suppressed zero type, gives exceptionally good readings, a portable unit which can be switchboard mounted, Westinghouse type U Graphic Voltmeter. The synchronous Telechron motor chart drive can be furnished for operation on 110, or 220, or 440 volt, for either 50 or 60 cycle. Complete with charts, ink, accessories, instructions, etc. (Specify voltage and frequency desired.)
List Price \$113.00 Your Cost Only \$65.00

A. C. VOLTMETER, DOUBLE RANGE, for 220 and 440 Volt systems, Ranges of 180 to 260 volts and 360 to 520 volts, Suppressed zero type, gives exceptionally good readings, a portable unit which can be switchboard mounted, Westinghouse type U Graphic Voltmeter. The synchronous Telechron motor chart drive can be furnished for 220 and 440 Volt, or 110 Volt, 50 or 60 cycle operation. Complete with 3 charts, ink, accessories, instructions, etc. (Specify voltage and frequency desired)
List Price \$131.00 Your Cost Only \$75.00

A. C. AMMETER, 0-5 AMP. Can be used with external current transformers for higher ranges, Westinghouse type U Graphic Ammeter, a portable unit which can be switchboard mounted. The synchronous Telechron motor chart drive can be supplied for operation on 110, or 220, or 440 volt, either 50 or 60 cycle. Complete with 3 charts, ink, accessories, instructions, etc. (specify voltage and frequency desired)
List Price \$107.00 Your Cost Only \$65.00

A. C. VOLTMETER, 0-500 VOLTS. A Highly accurate wide range instrument, Westinghouse type GY-40 Direct Action-Strip Chart Recorder. The synchronous Telechron motor chart drive can be furnished for operation on 110, or 220, or 440 Volt, either 50 or 60 cycles. Complete with 3 charts, ink, accessories, instructions, etc. (specify voltage and frequency desired)
List Price \$221.00 Your Cost Only \$125.00

RECORDING POLYPHASE WATTMETER. Dual Voltage, 230/460 Volts, 5 Amps. Can be used with external transformers for higher current ranges. A highly accurate versatile instrument, Westinghouse type GY-40 Direct Action-Strip Chart Recorder. The synchronous motor can be furnished for operation on 110, or 220, or 440 Volt, either 50 or 60 cycle. Complete with 3 charts, ink, accessories, instructions, etc. (specify voltage and frequency desired)
List Price \$247.00 Your Cost Only \$150.00

*** Includes New Factory Guaranteed Stock. All other items are Surplus New unless SPECIFICALLY indicated otherwise. All items are fully guaranteed.*

We specialize in electrical instruments. Over 75,000 meters in stock. Send for our latest circular showing our complete line of surplus-New-Guaranteed meters.

A.C. VOLTMETERS

15 Westinghouse 3 1/2" rd	@ \$5.50
150 Simpson 3 1/2" rd	@ ** 9.60
300 Simpson 3 1/2" rd	@ ** 9.60
300 Triplet 2 1/2" rd metal	@ 6.00

A.C. AMMETERS

100 milliamp Weston 3 1/2" rd 400 cycles	@ \$7.50
100 Weston 3 1/2" rd	@ ** 8.10
50 Simpson 3 1/2" rd	@ ** 9.30
200 Simpson 3 1/2" rd. 5 Amp less transformer	@ ** 8.10
Current Transformer Weston 200/5	@ 7.50

D.C. MICROAMMETERS

50 Simpson 3 1/2" rd. 2000 ohms	@ ** \$11.85
100 Weston 6 1/2" rd. approx. 1500 ohms	@ 21.00
200 Simpson 3 1/2" rd. 1000 Ohms	@ ** 9.60

R.F. AMMETERS

1.5 Weston, 2 1/2" rd. metal case, bl. sc.	@ \$4.50
2.5 Simpson, 3 1/2" rd.	@ 5.50
2.5 Weston, 3 1/2" rd.	@ 8.50
3, Westinghouse, 3 1/2" rd.	@ 6.50
3, Westinghouse, 3 1/2" rd. with ext. couple.	@ 7.50
5, General Electric, 3 1/2" rd.	@ 5.50
8, General Electric, 2 1/2" rd.	@ 5.50
8, Westinghouse, 3 1/2" rd.	@ 7.50
10, Weston, 3 1/2" rd. JAN.	@ 9.50

D.C. MILLIAMMETERS

1, McClintock, 3" square	@ \$6.00
2, Westinghouse, 3 1/2" rd.	@ 5.50
5-0-5, Western Electric, 3 1/2" rd spec. sc. concentric mtv	@ 4.00
15, Simpson, 3 1/2" rd.	@ 6.00
100, Simpson, 3 1/2" rd.	@ ** 8.70
150, General Electric, 3 1/2" rd.	@ 5.50
150, Green, 2 1/2" rd.	@ 9.50
200, Simpson, 3 1/2" rd.	@ 5.50
300, Simpson, 3 1/2" rd.	@ ** 8.70
400, Triplet, 3 1/2" rd. made for Garfield Med. App. Co.	@ 4.50
500, Simpson, 3 1/2" rd.	@ ** 8.70
500, Dejur, 3" square	@ 5.50
800, General Electric, 3 1/2" rd.	@ 5.50
800, Dejur, 3 1/2" rd.	@ 4.50

D.C. AMMETERS

1, General Electric, 3 1/2" rd.	@ \$5.50
30-0-30, General Electric, 2" rd. metal.	@ 4.50
200, Weston, 2 1/2" rd. with shunt	@ 7.50

D.C. VOLTMETERS

15, Simpson, 3 1/2" rd.	@ ** \$8.85
150, Hoyt, 3 1/2" rd. metal case	@ 4.50
300, Simpson, 3 1/2" rd.	@ ** 8.85
500, Weston, 2 1/2" rd. 1 MA. with resistor.	@ 9.50
4 KILOVOLTS, Dejur Amso, 3 1/2" rd. 1 MA. less multiplier	@ 4.50

PORTABLE TACHOMETER

Multiple Range Continuous Indicating
This unit is of the centrifugal mechanical type and is designed to show INSTANTANEOUSLY and CONTINUOUSLY the speed or change in speed of any revolving shaft or surface. No stop watch or other mechanism required.
• Three ranges in R.P.M. and three in F.P.M.
• LOW RANGE 300-1,200 (Ea. division equals 10 R.P.M.)
• MEDIUM RANGE 1,000-4,000 (Ea. division equals 10 R.P.M.)
• HIGH RANGE 3,000-12,000 (Ea. division equals 100 R.P.M.)
• Large open dial 4 diameter
• Ruggedly constructed for heavy duty service
• Ball bearing and oilless bearings
• Readily portable—fits neatly into hand
• Gear shift for selecting low, med., high ranges.
Made by Jones Motorola, Stamford, Connecticut
7 1/2" L x 4" H x 5" W **YOUR COST \$37.50**

SPECIAL METERS

Decibel, —10 to 6, Weston 301-61 3 1/2" rd.	@ \$11.50
Rect. Milliammeter, 1.1 MAAC Weston 545-81, sp scale	@ \$6.50
Micromhos meter, 1.4 MADC Simpson 3 1/2" rd	@ \$6.50

TEST INSTRUMENTS

Simpson 260 Set Tester	@ ** \$38.95
Simpson 240 Hammeter	@ ** 26.35
Simpson 230 V.O.M.A.	@ ** 24.95

WEATHER INSTRUMENTS

Friez Recording Microboregraph Cat. # 792	
Friez Psychrometer Cat. # 573	
Friez Thermograph—20° to 120°F	
Taylor Anemometer	
Ainor Velometer	
List or or \$1,400 Used—Guaranteed	Net \$400.00

MISCELLANEOUS

Frequency meters, 58-62 cycles, 115 volt, switchboard type, Westinghouse HY	@ \$50.00
Gasoline Heater, GN-3-24	@ \$22.50
Radio Receiver RC-1161-A	@ \$34.50
Radio Transmitter RC-1160-A	@ \$29.50

All items are fully guaranteed.

MARITIME SWITCHBOARD INSTRUMENTS—ACCESSORIES
338 Canal St., N. Y. 13, N. Y.
Worth 4-8217

Orders accepted from rated concerns, public institutions and agencies on open account, others please send 25% deposit, balance C.O.D. or check with order. All prices FOB our warehouse, N.Y.C.

AT
Big Saving!
FERRULE-TYPE RESISTORS

Immediate delivery from our stock of over 250,000.

Wide assortment from 0.2 to 300,000 ohms.

ENAMEL—GLASS
FIXED—ADJUSTABLE

New and in perfect condition.

Nearly all made to JAN specification.

Write for Catalog

UNIVERSAL MARINE & MFG. CORP.
137 Alexander St. Yonkers 2, N. Y.



ATTENTION INDUSTRIAL USERS ! ! !

We have large stocks of the following items and we invite your inquiries.

- | | |
|---------------------------------|------------------------------------|
| Amphenol Connectors | Oil-filled Capacitors |
| Allen-Bradley Potentiometers | High-voltage Mica Capacitors |
| A M P Terminals | High-voltage Oil-filled Capacitors |
| Burdny Hylugs | Mica & Silver Mica Capacitors |
| T & B "Sta-Kon" Terminals | Tubes |
| Dialco Panel Light Assemblies | Switchboard Meters |
| Superior Powerstats | Crystal Diodes |
| Ferrule Type Resistors | Interlock Switches |
| Relays, Transformers and Chokes | Key Switches |
| Synchros | Type FP Capacitors |
| Tube Sockets | Type G Capacitors |
| Hardware | Fiberglass Yarn |
| Contactors | Contactors & Contactor Coils |
| Magnet Wire & Hook-up Wire | T & B "Wedge-On" Terminals, |
| Vacuum Condensers | Glass-enclosed Relays |
| Gas-filled Condensers | Welding Rod; including Type 347 |
| | Tube Crocks |

We invite inquiries regarding items not listed above.

Replies will be made to your inquiries within twenty-four hours after they are received by us.

Key Electronics Division

1801 North Longwood Street

Baltimore 16, Maryland

R.C.A. Model MI-8167 TRANSMITTERS

Point-to-point communications



Freq. Range: 2000 to 20,000 Kcs.
 Output: 350 Watts C.W. 250 Watts Radio telephone
 Input: 190 to 250 Volts AC 50/60 cps.
 Size: 60" high, 17" wide, 27" deep.
 Tubes: 807s, 813s, 805s, 866s.
 Crystal Oscillator unit built-in, fully shielded and stable. All self contained including antenna network. Master Oscillator unit (available) fits in place of Xtal unit. Speech amplifier is only external unit and has 110/220 v. AC input, four stages, high gain. Total net weight, 625 lbs.

Complete! New! From Stock! Quantities!
 Prices on Request.

COMMUNICATION DEVICES CO.
 INCORPORATED
 2331 Twelfth Ave. N. Y. 27, N. Y.

WHOLESALE ONLY

**ELECTRONIC COMPONENTS
 AIRCRAFT EQUIPMENT
 HYDRAULICS**

RADIO & ELECTRONIC SURPLUS
 13933-9 Brush St. Detroit 3, Mich.
 Phone Townsend 9-3403

Wholesale Dealers in GOVERNMENT SURPLUS

- electronic components,
- units, wire, etc.

LAPIROW BROS.

1649 Hoffner St. Cincinnati 23, Ohio
 Kirby 1285

FOR SALE

Beryllium Copper Strip

.0071 x 3 x 96 inches 2000# available
 Beryllium 2%. Cobalt 3%

J. C. LIMOZAINÉ

1423 Kanawha St., Hyattsville, Maryland

IN STOCK IMMEDIATE SHIPMENT TUBES

6B860	12F5GT48
6B8G55	12K8GT50
6J8G65	5065
6L7G65	70L7GT85
6S7G60	8557
6U7G50	807	1.40
12A650	161940

Please Write for Up-to-Date Special Purpose
 Tube List with New Low Prices

All listings are Quality Guaranteed. Inquiries regarding these and other requirements given prompt attention. Usual discounts to manufacturers and jobbers.

PARTS

TRANSFORMERS

PLATE TRANSFORMER

5000 volt AC, center tapped, 350 MA.
 Primary 115 volt, 60 cycle. Unmounted
 and not potted, overall dimension 6 1/2
 inches x 6 inches x 7 inches, weight 37
 lbs. New. \$25.00

PULSE TRANSFORMER

68G828-G1

PLUGS

TELEPHONE PLUG, Equivalent to PL-55,
 with Screw Terminals Inserted. Samples
 furnished to quantity users. New. \$3.30

BUTTERFLY CONDENSER (A-PR-4TN-17)

Antenna Tuning Unit Condenser (C-302) for
 TN-17, 74-320 MC, in original package
 \$12.50

All items subject to prior sale. Shipments BEST
 WAY C.O.D. if desired. Rated accounts net ROG.

T. R. LOWENTHAL CO.

ELECTRONIC COMPONENTS

Technical Radio Since 1919

1205 West Sherwin Avenue, Chicago 26, Illinois
 Phone: Rogers Park 4-0784

REAL VALUES!

CATHODE RAY TUBES

3FP7	\$1.95	5CP1	\$4.95
4AP1095	5FP7	1.95
5BP4	3.95	5GP1	3.95
16DP4	\$19.95	16JP4	\$19.95

TUBES 9001	\$1.39	304 TH	\$8.95
9002	984	304 TL	\$8.95
9003	\$1.49	830 B	\$2.95

RA 52—RECTIFIER

A transtat controlled rectifier to produce high
 voltage DC from 110 VAC 60 cycle source. Up to
 1,500 volts DC at 50 watts. Metered high voltage
 (0-15KV) and current (0-20 MA). **\$74.50**

New
 Some available with small repair or minor part
 replacement, less tube. only \$49.50

SCR 625 Famous Army Mine Detectors for prospectors—miners—oil companies—plumbers—etc.,—

WHILE THEY LAST
 This unit is being offered now at
 a considerable reduction in price.
 Recently advertised at \$79.50 it is
 now available in the same brand new
 wrappings in suitcase style carrying
 case (less batteries) **\$39.50**

T85/APT-5	MD38/APQ13	R18/AP53
BC638	TS16APN	R70/AP515
BC1287	TS27/TSM	AS18/AP515
BC1077	TS61	RC213
I-83G	TS89	RT34/AP513
I-86A	TS92	RT28/APG4X
I-114	TS131	RT19/ARC4
I-183	TS159	RT48/TPX
I-185	TS170	RT73/UPN
I-187	TS184	RT10/AP53
I-198	TS251	AN/APT4
IE36A	TA-2J24	APS4
MD4/AP52	R132/TPS10	TS51
MD5/AP53	R9/APN4	TS69
MD22/UPN2		

PRICES UPON REQUEST

ARROW SALES, Inc.

Dept. E6

1712-14 S. Michigan Ave., Chicago 16, Ill.

PHONE: HARRISON 7-9374

PHOTOCON SALES

1062 N. Allen Ave. SY camore 4-7156
 Pasadena 7, Calif. RY an 1-8271

WRITE FOR OUR WINTER 24 PAGE SURPLUS SALES CATALOG

WE WILL BUY YOUR NEW OR CLEAN
 USED ELECTRONIC SURPLUS: ARC-1,
 ARC-3, BC-224, BC-348, BC-312, BC-342,
 ATC, ART-13, APS-13, BC-221, LM's,
 TS-12, TS-13, TS-23, TS-34, TS-35, IE-19A,
 I-222, SCR-522, TS-100, I-100, or any BC,
 I, IE, TS, APR.

WRITE FOR PRICES.

APR5A, TS-34, 804CS2, BC-348, ART-13,
 ARC-1, APN-9, BC-610, TCS, 304TL, 889R.
 TS-148/UP, Large Quantity BC-348's,
 TS-13, ID59/APA-11 Indicator. APR-4
 Tuning Units.

Weston 769 Electronic Analyzer	LIKE NEW	\$200.00
APN-1 Altimeter Indicator 0-1 ma. shunt, 250° dial	NEW	2.85
IE36A Test Sets for SCR-522	NEW	35.00
TS100/AP Oscilloscope	EXC.	99.50
DuMont 241 Oscillograph	EXC.	300.00
DuMont 208 Oscillograph	EXC.	225.00
G.E. CRO5Y Oscilloscope	EXC.	225.00
LM & BC-221 Frequency Meters xtal, tubes, cal. hook	EXC.	99.50
804 LX-1 UHF Sig. Gen. 8-350 mc. Com- plete	NEW	500.00
CRT-3 Two-channel Gibson Girl	NEW	75.00
Drafting Machine single scale 16" fulcrum less scale	EXC.	35.00
BC-463 Target xmttr 5 channel control 68-73 with tubes	EXCELLENT	100.00
TS-34/AP Portable Oscilloscope	LIKE NEW	600.00
	EXC. COND.	500.00

NOTE: One of the largest and most complete elec-
 tronic surplus stocks in the country. We have
 thousands of tubes, capacitors, plugs, accessories,
 transmitters-receivers, test equipment, etc. Send
 us your requirements.

TERMS: Prices F.O.B. Pasadena, California.
 25% on all C.O.D. orders. Californians
 add 3% Sales Tax. Prices subject to
 change without notice.

! WANTED !

Any Quantity or Make **723A/B** TOP CASH
 PRICES

Also 3C45, 5C22, 6J4 & 393-A.

Please include our name on your mailing list!

NOTE: We must receive your quotation
 on 723 A/B before Feb. 29.

PHONE: LEHIGH 5-4731. WRITE:

Attn. S. J. DORSA

242 E. 77 ST., N.Y.C. 21

IF THERE IS

Anything you want

that other readers of this paper can
 supply

OR—

Something you

don't want

that other readers can use, adver-
 tise it in the

Searchlight Section

QUARTZ CRYSTALS

Made from the finest Brazilian quartz and will provide a high degree of activity and frequency stability. It is made to a frequency of F.01 % in conventional amateur oscillator temperature coefficient is less than 3 cycles per megacycle per degree centigrade.

Price 1.15 each—25 for \$25.00

Available in F-243 or CL16 in the following frequencies:—In K.C.

*2356 to 2358	6250	8026 to 8041
*2500 to 2581	6275 to 6350	8050
*2600 to 2674	6400	8051 to 8066
2800	6433 to 6475	8075
*3000 to 3078	6500 to 6600	8080 to 8083
3150	6625	8100
*3151 to 3200	6686 to 6783	8224 to 8888
3350	6815	9100 to 9300
*3615 to 3700	6830	9335 to 9399
3701 to 3799	6843 to 7000	9400 to 9499
3801 to 3890	7156 to 7299	9500
3912 to 3946	7312 to 7398	9501 to 9589
4000 to 4290	7400 to 7450	9608 to 9800
4300	7509 to 7597	10000 to 10010
4301 to 4366	7603 to 7618	10075
4400 to 4470	7625	12602 to 12699
4500 to 4595	7650	12700 to 12798
4600 to 4699	7675	12800 to 12899
4700 to 4799	7700	12902 to 12998
4800 to 4899	7701 to 7716	13001 to 13196
4900 to 4988	7725	13202 to 13299
5000 to 5092	7750	13302 to 13399
5100 to 5280	7759 to 7773	13400 to 13496
5317 to 5380	7775	13500 to 13598
5405 to 5450	7778 to 7794	13603 to 13698
5500 to 5558	7800	13702 to 13799
5605 to 5695	7825	13802 to 13897
5750 to 5760	7850	13903 to 13996
5800 to 5896	7875	14000 to 14099
5910 to 5965	7900	14102 to 14198
6000 to 6080	7925	14200 to 14298
6150 to 6162	7950	14300 to 14398
6175	7975	14400 to 14542
6200	8000	
6225	8025	

Type CR-1A/AR or XL11
Price .95 each 25 for \$20.00

4000 to 4788	6500 to 6590
5000 to 5090	6600 to 6685
5100	6815 to 6890
5120 to 5180	6905 to 6980
5200 to 5230	7010 to 7080
5250	7218 to 7330
5270 to 5295	7440 to 7500
5300 to 5396	7560
5410 to 5648	7600 to 7675
5740 to 5780	7700 to 7790
5810 to 5891	7800 to 7880
5910	7900
5923 to 6000	7910 to 7990
6010 to 6080	8000 to 8094
6130 to 6181	8115 to 8194
6200 to 6275	8213 to 8298
6300 to 6375	8300 to 8370
6370	8405 to 8490
6400	8500 to 8567
6401 to 6464	8630 to 8650
6470	11677
6475 to 6499	

Type CRL-33
Price \$1.15 ea.
25 for \$25.00

Type XL5
Crystals—
Price \$1.35 ea.

920 to 1000
1300 to 1358
1616 to 1628
1705 to 2150
2200 to 2384
2410 to 2455
2561 to 2698
2704 to 2787
2801 to 2916
3105 to 3171
3232 to 3375
3410 to 3557

* Frequencies indicated above from and to, are to show that there are available crystals in small quantities in successive steps between these values, i.e., 14406 to 145452—available crystals are 14401, 14402, etc.
Where single frequency is shown, a quantity of 50 or more crystals are available in that frequency.

We have substantially large quantities of desirable electronic materials at bargain prices listed in our catalogue #ED5.
To obtain a copy please write to:

154 GREENWICH ST.
New York, N. Y.
Telephone DI 9-3143

EDLIE ELECTRONICS, Inc.

Your Best Buys in TRANSMITTING TUBES

Made By Nationally Known Tube Mfr.
NEW, BOXED, FACTORY PRE-TESTED
GUARANTEED

IMMEDIATE DELIVERY

10% Discount on Orders Over \$500

Type	Price Each	Type	Price Each
HF60	\$2.65	343A	\$115.00
HF100	6.00	450TL	39.50
111A	5.45	468	8.50
HF120	4.50	492	125.00
ZB120	4.50	502R	70.00
AX4-125A	15.00	504R	75.00
HF125	8.50	508	150.00
HF130	6.25	520MT	67.50
HF140	5.50	562A	85.00
HF150	6.25	673	12.95
HF175	7.25	807	1.49
HF200	12.95	813	7.00
HF201A	9.00	830	2.75
203A	7.50	833A	39.50
203WA	8.50	836	2.95
204A	40.00	837	1.25
211B	6.75	845	4.00
211D	6.75	846	100.00
212	37.50	849	17.50
212E	37.50	849A	24.50
217C	7.00	849H	45.00
221A	18.00	857B	90.00
222A	125.00	858	180.00
228A	100.00	859	175.00
HF250	12.00	866A	1.15
255B	85.00	869B	27.50
267B	8.95	872A	2.00
270A	45.00	889A	99.50
HF300	14.95	892	125.00
301A	5.00	1652	115.00
304B	4.50	Z13200	155.00
308A	35.00	5331	125.00
311CH	7.95	5332	125.00
315AW	15.00	5666	125.00
331	4.50	8002R	77.50
332A	14.50	8011	1.00
333A	16.25		

Sold on money back guarantee

GET PACE PRICES
ON OTHER TUBES BEFORE BUYING
ALL PRICES F.O.B. N. Y. MINIMUM ORDER \$5
20% DEPOSIT (Check or Money Order)
Balance sent C.O.D.
Rated Companies—Send Purchase Order

Cash for your surplus inventories

J.A.N.'s			
Type	Price Each	Type	Price Each
OZ4A	\$.85	249C	\$ 3.95
2J31	24.50	250R	6.00
2J34	25.00	267B	8.95
2J37	9.95	307A	3.50
2J39	39.50	371B	.70
2X2	.45	715A	4.95
3B7	.50	803	3.25
3D6	.35	805	3.25
5FP7	1.95	814	3.25
5HP1	7.75	830B	2.75
CGJ	4.95	841	.35
10	.35	864	.35
10T1	.50	876	.49
RR34	.69	878	1.50
25T	3.50	957	.49
UH50	4.00	958A	.50
GAM 54	2.50	1616	.70
VR150	3.00	1622	.30
218	45.00	1626	.30
227A	3.89	8012	2.25
231	.95	8019	1.75

Pace

ELECTRONICS CORP

190 WASHINGTON ST. NEW YORK 7, N. Y.
Phone NY 2-1042-3

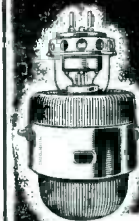

**MANUFACTURERS!
EXPORTERS!
PURCHASING AGENTS!**

- HONESTY
- INTEGRITY
- QUALITY OF PRODUCT

- Radio and Receiving Tubes
- Transmitting & Special Purpose Tubes
- Radio and Electronics Parts and Equipment
- All Types of Electrical Wire, Magnet Wire, and Cable

Write — Wire — Phone
For Your Special Needs

We are also bonafide
General Purchasing Agents.
CAN WE HELP YOU?

References: Dun & Bradstreet.

Electronic Expeditors

225 N. Wabash Ave., Dept. E, Chicago 1, Ill.
Phone ANdover 3-0841

BRANCH OFFICES

9015 Wilshire Blvd., Beverly Hills, Cal., CR 4-6237
507 Fifth Ave., New York 17, New York, MU 7-0084

The SEARCHLIGHT SECTIONS

(Classified Advertising)

of McGraw-Hill Publications

can help you by bringing business needs or "opportunities" to the attention of other men associated in executive, management, sales and responsible technical, engineering and operating capacities with the industries served by:

American Machinist
Aviation Week
Business Week
Bus Transportation
Chemical Engineering
Chemical Week
Coal Age
Construction Methods and Equipment
Electrical Construction & Maintenance
Electrical Merchandising
Electrical Wholesaling
Electrical World
Electronics
Engineering and Mining Journal
E. & M. J. Markets
Engineering News-Record
Factory Management and Maintenance
Food Engineering
Power
Product Engineering
Textile World
Welding Engineer

"SEARCHLIGHT" Can Help You!

HUNDREDS of miscellaneous business problems that confront you from time to time, can be quickly and easily solved through the use of the Searchlight Section of this or other McGraw-Hill publications.

The Searchlight Section is the classified advertising appearing in each of these papers. You can use it at small cost, to announce all kinds of business wants of interest to other men in the fields served by these publications. It is the regular meeting place of the man with a miscellaneous business need and the men who can fill that need.

When you want additional employees, want to buy or sell surplus used or new equipment, want additional products to manufacture, seek additional capital, or have other miscellaneous business wants—advertise them in the Searchlight Section for quick, profitable results!

Classified Advertising Division

McGraw-Hill Publishing Co., Inc.

330 West 42nd Street, New York 36, N. Y.

CONDENSERS

OIL CONDENSER SPECIAL 10 mfd.—600 V . . . \$.89

Three term, bat. mtng. channel type. Dims. 3 3/4" x 3 1/2" x 2". Two 5 mfd. sections rated 400 V at 72 deg. "C". 1800 V test. Meets commercial specs. for 600 V. operation up to 40 degs. "C". Ideal for filter or power factor application. Repeat sales prove this rugged high quality condenser to be of outstanding value. Carton of 24, weight 42 lbs. Large qua. available . . . \$.79

16 mfd.—600 V . . . \$1.75
Dual 8 mfd. herm. sealed and packed. Type PT-SC-11 measuring 3 3/4" x 2 9/8" x 2 5/8". Stud mtg. centers 2". Plugs into standard four prong socket. Quantity discount.

8 mfd.—1000 V . . . \$2.39
Dual 4 mfd. oil cond. herm. sealed and packed. Case of 10 . . . \$2.10 ea.; 100 . . . \$1.85

6 mfd.—150 V . . . \$.25
Three term. dual 3 mfd. oil cond. complete with brackets, measuring 4 1/4" x 1 3/4" x 1". Ideal for audio crossover networks.

7 mfd.—600 V . . . \$1.45
Small, high quality oil cond. measuring 2 1/8" x 3 3/4" x 1 3/4" complete with brackets.

.2 mfd.—1000 V . . . \$.19
Standard 2 side term. bathtub cond. Same dimensions as .25 mfd, 600 V type. Exceptional value.

*6 mfd.—600 V—CP 70 B1 FF
605 K bkts. . . . \$1.55

*8 mfd.—1000 V—CP 70 E1
EG 805 K . . . \$3.25
* Current production.

MISCELLANEOUS

- 100 mmfd ceramic cond.— \$15.00 per "5C"
- 150 or 500 mmfd S. Mica Cond. \$30.00 per "5C"
- 50K pot. 1/8" s.d. @95¢
- DPST tog. sw. bat handle @ .45¢
- .01 mfd—1000 V Molded Paper "K" tol. @10¢

See Jan. Electronics Page 340

For many other listings of condensers, switches, relays, etc. Inquiries solicited.

MONMOUTH RADIO LABORATORIES

BOX 159

Long Branch 6-5192

OAKHURST, N. J.



WE HAVE LARGE QUANTITIES OF RADIO TUBES

TYPE	PRICE	TYPE	PRICE	TYPE	PRICE	*****
OZ4A	\$0.70	6B8G	\$0.93	6SK7GT	\$0.96	★
1G6GT	0.72	6BE6	1.20	6SN7GT	1.20	★
1LN5	0.80	6C4	0.86	6SS7	0.95	★
1R5	0.90	6C5GT	0.51	12A6	0.48	★
1S4	0.86	6C6	0.75	12SH7	0.96	★
1T4	0.86	6H6	0.94	12SK7	0.98	★
5U4G	0.80	6J5	0.60	12SQ7GT	0.90	★
6AB7	0.90	6J5GT	0.51	12SR7	0.90	★
6AC7	1.20	6K6GT	0.91	35Z4GT	0.85	★
6AL5	1.00	6K7GT	0.70	35Z5GT	0.75	★
6AQ5	1.40	6SG7	0.90	50L6GT	0.90	★
6B8	0.93	6SK7	0.96	49	0.76	★

This offer subject to change and prior sale.

SPECIAL SALE OUR PRICE: \$2.90
TYPE 805 List Price: \$13.50

METROPOLITAN OVERSEAS SUPPLY CORPORATION
MANUFACTURERS AND DISTRIBUTORS OF ELECTRONIC PRODUCTS
1133 BROADWAY, NEW YORK 10, N. Y. CHELSEA 3-1105

80 to 3000 Mcs! RADAR SEARCH RECEIVER ARD-2

Will measure RF signals from 80 to 3000 MCS and pulse rates from 50 to 8000 cycles. It can also locate transmitted signal sources by visual and aural indicators. EQUIPMENT: Consists of the following: 1 ANTENNA-DETECTOR (CMD-66AFH) has variable length antennas (2), diode detector, and silver plated tuning stub with calibrated scale; 1 AMPLIFIER (CMD-50ADC) has three stage pulse amplifier, a trigger circuit, a pulse rate counter circuit and audio amplifier, a visual signal indicator and a rectifier power supply which is operative on 115 Volts AC, single phase, at 60 to 2400 cycle current regulated; 1 TEST OSCILLATOR (CMD-60ARG) has cavity frequency of 400 cycles with selection of four pulse repetition rates. With the above are included all cables with fittings, accessories, and shock mounted rack, a steel chest with complete spare parts and 200% additional tubes and 2 technical manuals. Gross weight 113 pounds.

BRAND NEW! ORIGINAL PACKING! Complete! Price, each . . . \$225.00
Equipment and Accessories for Radio Communications

Other Choice Selected Equipment and Accessories for Radio Communications—Handy-Talkies, Walkie-Talkies, Portable Radars also Available.

Pictorial listings on request
COMMUNICATION DEVICES CO.
2331 Twelfth Ave. N.Y.C. 27, N. Y.
Cable: Communidev Tel: AD-4-6174, 5

TUBES STANDARD BRANDS FIRST QUALITY TUBES

1B22	2.25	3D640	316A	1.35	728FY	25.00	163085	C5B	8.75	3CP1	1.75	heater-6.3
1E145	4A1	1.50	329A	8.50	728GY	25.00	163270	C6A	6.75	3CP1 S1	2.25	.0475 ma
1P23	3.50	4B24	5.50	371A	1.25	80135	163360	CK100545	3DP1	4.50	plate-100v.
2C22	4.45	4B25	8.00	446A	4.50	803	3.50	164480	CRP72	1.25	3EP1	5.25	5-13 ma
2C2625	5J29	11.50	450TH	35.00	805	3.75	2051	1.25	EL6C	8.75	5AP1	3.50	bias-18v neg.
2C26A50	6-435	700A	25.00	82675	8013	2.50	HY31Z	2.50	5BP4	3.75	amp. factor
2E22	1.25	6 Amp Tungar	4.25	700B	25.00	835	10.00	8020	1.25	HY114B65	5CP1	4.75	3.6-4.6
2J21A	8.75	10Y65	700C	25.00	837	1.35	9003	1.00	HY161525	5HP1	4.75	
2J26	25.00	12A645	702A	3.00	874	1.10	900635	RK3475	7BP7	6.50	
2J27	25.00	14E665	704A85	87685	CE1-C	2.50	RK47	3.75	7GP1	9.50	
2J31	27.50	15E	1.00	705A	2.25	920	2.50	CE2-A	2.50	SD828	1.25	7HP4	9.50	
2J40	35.00	24G	1.75	708A	4.50	95435	CE2-B	2.50	VR9275	10CP4	17.50	6AQ5 Jan
2J51	45.00	35T	4.00	715B	9.00	95535	CE2-C	2.50	WL481	1.50	EX1515	10.00	6AK5 Jan
2J61	50.00	101L	1.25	717A	1.25	95635	CE2-T	2.50	WL532A	2.25	SPECIAL	6V6GT Jan	
2J61A	50.00	203Z	4.50	728AY	25.00	95735	CE2575	WL670A	8.00	Sylvania sub-miniature	6SL7 Jan	
2J531	8.00	286A	7.50	728BY	25.00	161675	CE25-C75	C.R.T.	8.75	SC968 \$1.95 ea.	12SL7 Jan	
2X250	304TH	10.00	728DY	25.00	162535	CIA	8.75	3BP1	6.50		6SN7 Jan	
3A475	313C	2.75	728EY	25.00	162645	CIB	3.00				12AU7 Jan	
3B27	3.50													1.10
3C31-CIB	3.00													

All Radio & TV receiving tubes 50% off list. 25% deposit required on orders, rated firms send P.O. All merchandise guaranteed. Prices subject to change without notice. Merchandise subject to prior sale.

ROLE ELECTRONICS INC.

114-118 Liberty Street

Rector 2-8078

New York City

We're not eyeing! We're not trying!

WE ARE BUYING

all and any type of electronic parts or equipment that is surplus to your needs. Send us your listings and samples if possible. We promise a prompt reply in 23 HOURS or less.

The following for sale:

Hi Voltage Plate Transformer and Choke Combination (for the SCR 602)

Transformer specs.	Height 11 ins.
Pri. 80V—1200 cycle. 2.5 amps.	Width 6 1/2" X 4"
200 VA.	
Sec. 4000V @ .05 Amps.	Choke Specs.
Weight 21 lbs. 4 Oz.	Inductance 120 Henries @ .05
	Amps. Insulated for 16000 VDC.

Condition, brand new. Price \$22.50

GR Variacs Type 5 (5 Amp) Cond. used, good.....	\$15.95
Kenyon Type S-13377 5V @ 60 Amp. CT. Cond. good.....	\$10.95
Haydon Timer Motors 110V—25 cycle 2W 95 rpm. new.....	\$ 1.59
BC 706D Inertia Switches Brand New.....	\$ 1.75
BC 1073 Wavemeter and power supply less tubes.....	\$11.95
Westinghouse Type K31 Coaxial Cable (similar to RG 8U).....	.08¢ per FT.



CAROL DISTRIBUTING CO.

1005 W. NORTH AVE.
BALTIMORE 17, MD.
PHONE LA 4045

WANTED

WANTED
QUARTZ CRYSTAL UNITS
in holders, FT-171; FT-241; FT-243; FT-500. Any quantity. Advise condition.
W-2317, Electronics
330 W. 42 St., New York 18, N. Y.

WANTED

YOUR SPARE SURPLUS EQUIPMENT
DYNAMOTORS • SELSYNS • AUTOSYNS • INVERTERS • TRANSMITTERS
RECEIVERS • TEST EQUIPMENT
Please send list stating condition and lowest price.
No Quantity Too Small or Too Large!
C & H SALES COMPANY
BOX 356-SE EAST PASADENA STATION PASADENA 8, CALIFORNIA



EQUIPMENT WANTED!

NOTE NEW ADDRESS BELOW

We want to buy all types of surplus electronic equipment. We are one of the largest buyers in U. S. We buy more because we give every seller top prices and a fair deal. TELL US WHAT YOU HAVE. USE COUPON BELOW—AND MAIL TODAY!

Use following numbers to indicate conditions: N-1, brand new; N-2, used, like new; N-3, used.

ITEM	CONDITION	PRICE WANTED

To: COLUMBIA ELECTRONICS LTD., 7460 N. Varna Ave., N. Hollywood, Calif.

Name
Address

SEE COLUMBIA ELECTRONICS AD ON PAGE 368

TELEPHONE EQUIPMENT & PARTS

Brand New RM29 Remote Control Units, export packed, with carrying bag.....\$16.00 Ea.
Reconditioned & Tested EE8 field Telephones \$20.00 each
New TS9 handsets with flip switch.....\$6.50 each
W. E. Receivers, D9654.....\$5.00 each
Rebuilt like new Automatic Electric, Kellogg Western Electric solid handsets with new 3 Conductor cords.....\$4.95 each
New Receiver & Transmitter elements for the Telephone handset which are similar & interchangeable with the W.E.HAI & FI.....\$1.00 each
New operators head & Chest sets.....\$6.00 each
New W.E. Chest sets with FI T-26.....\$4.00 each
New W.E.T30Q throat mikes.....\$.50 each
A.E. Type 41 receiver elements for TS13.....\$.75 each
New Cranks GC9 for EE8.....\$.25 each
New Capacitors CA355 for EE8.....\$.50 each
New TS9 switches.....\$.30 each
New C-105 Induction coils.....\$.75 each
New C-158 holding coils.....\$.35 each
Lever switches for EE8.....\$.30 each
C-161 Repeat coils.....\$.20 each
C-114 loading Coils.....\$.10 each
TM 184 terminal strips.....\$.20.00 each
New W.E.706A receivers less cord but with HAI receiver.....\$2.00 each
New W.E.B-365 Relays.....\$.25 each
New 3A varistors.....\$.90 each
New W.E.44A connector Blocks.....\$.50 each
New W.E. Equalizers D164752B.....\$.70 each
New W.E.A2 switchboard lamps.....\$10.00 per 100
New Kellogg 40 volt switchboard lamps.....\$10.00 per 100
New Kellogg, white opal, lamp caps #79.....\$10.00 per 100
New A.E. Type 41 transmitters, low imp \$1.50 each
W.E. Dial Blanks.....\$.25 each
W.E. #26 protector blocks.....\$10.00 per 100
A.E. Sound power transmitter elements.....\$3.00 each
Rebuilt Sound power handsets with new.....\$5.50 each
New 6' Kellogg 4 conductor telephone cords.....\$.60 each... 3 Conductor \$.50
New Swbd. 2 Conductor CD-605 Rubber cords.....\$.35 each
Upright desk telephones, for extensions, intercoms, etc.....\$5.00 each
Kellogg 83B receivers 48 ohms.....\$1.00 each
5-Bar generators.....\$.45 each
Battery Eliminators NEW, for Intercoms, etc., 115A.C. to 8-12 Volts D.C. & 0-12 volts A.C.....\$29.50 each
New 82A induction coils.....\$.50 for 5
PLQ-103.....\$.90 each
Control Boxes BC-369.....\$1.00 each
New Allen Bradley relays 25V.-50 amps D.C.....\$1.00 each
New Electrolytic Condensers 250V.D.C.-0 to 65C. (.75MF-115MF.).....\$.90 each
New Capacitors 4MF Paper.....\$.40 each
Cook Relays—Turns 2200—Ohms 12—Spring bank—6 makes—1 break.....\$2.50 each
TS-15A handsets with flip switch and rubber cord with PL68 & PL55 plug Capacitor.....\$.85 each
Kellogg—1 & 2 Mfd.....\$.50 each
Canvas Carrying Bag (RM29) CS-76B W/leather bottom, Brand New.....\$1.75 each
CA-389 .50Mfd.-1MFD—600V. D.C.....\$.90 each
CA 275 4 MFD—50V. D.C.....\$.75 each
C-280 transformers.....\$1.00 each
JK 34A.....\$.50 each
JK 33A.....\$.50 each
JK 37.....\$.75 each
New 41 Inch rubber cords with either PL68 or P155 Plugs.....\$1.00 each
Switch SW 175.....\$.80 each
Switch SW 185.....\$.90 each

Terms: Check with Order F.O.B. Brooklyn 5, N. Y.

EASTERN TELEPHONE CO.
323 Vanderbilt Ave. Brooklyn 5, N. Y.
MAIN 2-3753

CONDENSERS OUR SPECIALTY

OIL FILLED & TRANSMITTING MICA TYPES
All Values and Voltage Ratings
We Invite Your Inquiries
TECHNICAL RADIO PARTS CO.
557 McDonald Ave., Brooklyn 18, N. Y.

ELECTRONIC TUBE-MAKING MACHINERY

For manufacturing radio tubes, electronic tubes, cathode-ray tubes, lamps. New and used. Reasonably priced, satisfaction guaranteed.

AMERICAN ELECTRICAL SALES CO.
67 E. 8th St. New York, N. Y.

FOR SALE

General Radio Primary Frequency Standard Class C-21 Hld With Measuring Equipment New Synchronometer and Crystal

CHIEF ENGINEER
KENT ENGINEERING CO.
5743 W. NORTH AVE. CHICAGO, ILL.
Tuxedo 9-6569

INDEX TO ADVERTISERS

Acheson Colloids Corp.	171
Acme Electronics, Inc.	333
Adams & Westlake Company, The	241
Advertising Council	259
Aeronautical Communications Equipment, Inc.	179
Air Associates, Inc.	295
Aircraft-Marine Products, Inc.	295
Airlyte Electronics Company	329
Airpax Products Company	212
Alden Products Co.	35
Allen Co., Inc., L. B.	344
Allen Manufacturing Company	254
Allied Control Company, Inc.	148, 344
American Cancer Society	313
American Gas Accumulator Company	246
American Lava Corp.	191
American Phenolic Corp.	142
American Television & Radio Co.	250
American Time Products, Inc.	152
Amperex Electronics Corp.	Third Cover
Amplex Electric Corp.	212
Andrew Corporation	198
Arkwright Finishing Company	196
Armo Steel Corporation	319
Armour Research Foundation of Illinois Institute of Technology	310
Arnold Engineering Company	156
Art Wire & Stamping Co.	334

Ballantine Laboratories, Inc.	182
Barry Corporation	13
Bead Chain Manufacturing Co.	303
Bell Telephone Laboratories	227
Bendix Aviation Corporation, Eclipse-Pioneer Division, Pacific Division	292
Bentley, Harris Mfg. Co.	206
Berkeley Scientific Corporation	149
Bird Electronic Corp.	190
Bird and Co., Inc., Richard H.	326
Birmingham Sound Reproducers, Ltd.	331
Birnbach Radio Co., Inc.	317
Bircher Corporation	327
Billey Electric Company	327
Bodnar Industries, Inc.	276
Boeing Airplane Company	335
Bogue Electric Mfg. Co.	279
Bomac Laboratories, Inc.	239
Boonton Radio Corporation	41
Borg Corp., George W.	137
Bowmar Instrument Corp.	324, 325
Bowser, Inc.	242
Bradley Laboratories, Inc.	208
Braud & Co., Inc., William	72
Bridgeport Brass Co.	186
Brown Electro-Measurement Corp.	269
Browning Laboratories, Inc.	315
Brush Development Company	288
Burnell and Company	74
Burstein-Applebee Co.	48
Bussmann Mfg. Co.	329
	151

Cambridge Thermionic Corp.	64
Cannon Electric Co.	164
Carborundum Company	52
Centralab, Div. Globe-Union, Inc.	9, 10, 11
Chase Brass & Copper, Sub. of Kemecott Copper Corp.	141
Chester Cable Corp.	275
Chicago Telephone Supply Corporation	28, 29

Chicago Transformer Div. of Essex Wire Corp.	170
Cinch Manufacturing Corp.	133
Clare and Co., C. P.	63
Cleco Div. of the Reed Roller Bit Co.	77
Cleveland Container Company	207
Cleveland Instrument Laboratory, Inc.	281
Cohn Corporation, Sigmund	300
Cole Steel Equipment Co.	32
Collins Radio Company	223
Communication Accessories Co.	168
Condenser Products Company	19
Conn. Ltd., C. G.	310
Consolidated Engineering Corp.	139
Continental Diamond Fibre Company	31
Cornell-Dubilier Electric Corp.	43
Corry-Jamestown Mfg. Corp.	180
Coto-Coil Co., Inc.	176
Cramer Co., Inc., R. W.	167
Crescent Company, Inc.	230
Cross Co., H.	323
Curtis Development & Mfg. Co.	254

Dale Products, Inc.	328
Dano Electric Company	262
Daven Company	253
DeJur Amco Corporation	302
DeMambo Radio Supply Co., Inc.	325
Dial Light Company of America	306
Distillation Products Industries	166
Dolin Metal Products, Inc.	385
Dow Corning Corporation	66, 234
Driver-Harris Company	177
Dumont Electric Corp.	268
DuMont Laboratories, Inc., Allen B.	68
Durant Manufacturing Co.	321
DX Radio Products Co.	230

Eastern Air Devices, Inc.	298
Eastman Kodak Company, Industrial Photographic Div.	143
Edison Incorporated, Thomas A.	281
Eisler Engineering Company, Inc.	262, 344
Eitel-McCullough, Inc.	33, 308
Elastic Stop Nut Corp. of America	209
Electran Mfg. Co.	324
Electrical Industries, Inc.	229
Electrical Reactance Corp.	161
El-Tronics, Inc.	344
Electro Motive Mfg. Co., Inc.	15
Electro Tec Corporation	233
Electro-Tech Equipment Co.	333
Electronic Associates, Inc.	225
Electronic Devices, Inc.	285
Electronic Instrument Co., Inc.	296
Electronic Measurements Company	216
Electronic Systems Co.	336
Erie Resistor Corp.	21

Fairchild Camera & Instrument Corp.	235
Federal Telephone & Radio Corporation	255
Federated Purchaser, Inc.	309
Filtron Co., Inc.	385
Five Star Co.	344
Freed Transformer Co., Inc.	291
Frequency Standards	339

ENGINEERS DEPEND UPON

FILTRON

for RF INTERFERENCE
SUPPRESSION FILTERS



CONSOLIDATED VULTEE
B-36 BOMBER



**FILTRON IS SPECIFIED ON
THE MAJORITY OF MODERN
AIRCRAFT, GUIDED MISSILES,
SIGNAL CORPS, ORDNANCE
AND NAVAL EQUIPMENT**

FILTRON'S experienced RF Interference Suppression engineers are available for the measuring, testing, and filter design for your equipment. The modern shielded laboratories are equipped to measure RF Interference from 14 KC to 1000 MC, in accordance with military specifications.

FILTRON'S engineers have more than 700 standard filters available, or will design a unit to meet your size, weight, mounting, voltage and current requirements.

FILTRON'S capacitor manufacturing and coil winding divisions, metal fabrication shop and metal stamping departments are exclusively producing the highest quality components for FILTRON'S RF Interference filters.

RF INTERFERENCE SUPPRESSION FILTERS FOR:

Motors	Dynamotors
Generators	Power Plants
Inverters	Actuators
Electronic Controls	Gasoline Engines

And other RF Interference producing equipment

Send for our LATEST CATALOG
on your company letterhead

THE **FILTRON** CO., INC.
FLUSHING, LONG ISLAND, N. Y.

LARGEST EXCLUSIVE MANUFACTURERS
OF RF INTERFERENCE FILTERS

for **NAVY SPARE-PARTS BOXES** IN STRICT ACCORDANCE WITH SPEC. #JAN-B233

19 STOCK SIZES - AT PUBLISHED PRICES!

NOW available to you
without costly sub-contracting problems

stock standard **TYPE M, STEEL SPARE-PARTS BOXES**, made in strict accordance with Navy Specifications.

To better service your need for Specification Spare-Parts Boxes (shipboard use), we have taken them from our "Special" department and put them on a mass production line. **RESULT:** they can now, in most cases, be shipped from stock.

SIMPLY ORDER THEM BY STOCK NUMBER
WRITE FOR SIZE AND PRICE CHART

TYPE M NAVY 42B9C

DOLIN METAL PRODUCTS, INC.
319 LEXINGTON AVE. - BROOKLYN 16, N. Y.

FOR UNIFORM RESULTS all over the country



WESTERN ELECTRIC
CALLED THIS
NUMBER

SB-3

(Type T-50)



PANORAMIC PANALYZOR

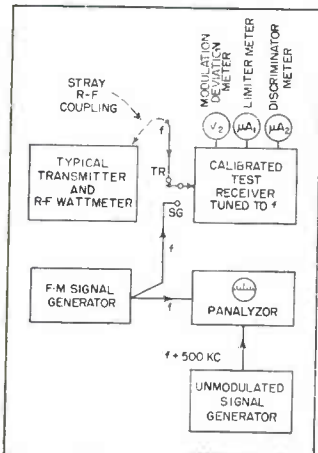

Western Electric's setup for calibration of modulation deviation of test receivers and signal generators.

THE PROBLEM:

To check p-m and f-m mobile telephone transmitters such as those used in highway and urban service to produce uniform performance wherever located.

THE SOLUTION:

Panalyzer SB-3 allows accurate, uniform results in different locations all over the country by helping to solve the complex problem of maintenance and calibration of f-m and p-m transmitter testing sets. Western Electric uses SB-3 to calibrate deviation meters and controls in f-m signal generators and deviation meters in test receivers. Panalyzer's visual presentation of the spectrum distribution of f-m and p-m modulated carriers greatly simplifies determination of modulation deviation. SB-3 is a natural for indicating minimum and maximum levels of carrier and side bands.

WRITE FOR REPRINTS

Western Electric reported full details of this testing set-up in a recent issue of Electronics. Reprints will be sent free on request.

WRITE, WIRE OR PHONE TODAY FOR COMPLETE INFORMATION

10 South Second Avenue, Mount Vernon, N. Y.
MOUNT VERNON 4-3970



Furst Electronics	338
Fusite Corporation	25
Gair Company, Inc., Robert	327
Gamewell Company	304
Gates Radio Co.	51
General Control Co.	208
General Electric Company	
Apparatus Dept.	46, 47, 165, 242
Chemical Dept.	314
Electronics Dept.	53
General Industries Co.	192
General Precision Laboratory, Inc.	181
General Radio Company	174, 175
Giannini & Co., Inc., G. M.	332
Grant Pulley & Hardware Co.	332
Graphite Metallizing Corp.	192
Grayhill	340
Green Instrument Co.	258
Gries Reproducer Corp.	342
Guardian Electric Mfg. Co.	173
Guthman Co., Inc., E. I.	244

Hardman Co., H. V.	312
Hardwick, Hindle, Inc.	51
Haydon Company, A. W.	216
Haydon Manufacturing Co., Inc.	78, 79
Heath Company	251
Helland Research Corporation	315
Helmemann Electric Co.	205
Helipot Corporation	157
Hewlett-Packard Company	65, 73
Hexacon Electric Company	315
Howard Sales Co.	344
Hughes Aircraft Company	351

Improved Seamless Wire Company, The	336
Indiana Steel Products Company	57
Industrial Condenser Corp.	304
Industrial Control Co.	334
Industrial Hardware Mfg. Co., Inc.	340
Industrial Rectifier Company	342
Industrial Tape Corp.	307
Industrial Timer Corporation	283
Instrument Corporation of America	40
Instrument Resistors Company	226
Insulation Manufacturers Corp.	277
International Rectifier Corp.	62
International Resistance Company	44, 45
Irrington Varnish & Insulator Co.	247

JFD Manufacturing Co., Inc.	339
Jelliff Manufacturing Corp., C. O.	330
Johns-Manville	287
Johnson Co., E. F.	282, 331
Jones Div., Howard B. Cinch Mfg. Corp.	302
Jones Electronics Company, M. C.	337
Joy Manufacturing Company	215

Kable Engineering Co.	246
Karp Metal Products Co., Inc.	55
Kartron	344
Kellogg Switchboard & Supply Co.	321
Kenyon Transformer Company, Inc.	164
Kester Solder Company	221
Kinney Manufacturing Company	38
Kirchberger & Company, Inc., M.	298
Klein & Sons, Mathias	180
Knights Co. James	234
Krohn-Hite Instrument Company	218

Laboratory for Electronics, Inc.	163
Lambda Electronics Corp.	308
Lampkin Laboratories, Inc.	344
LaPointe-Plascomold Corp. (Vee-D-X)	276
Lapp Insulator Co., Inc.	261
Leach Relay Company	236
Leeds & Northrup Co.	291
Leland Inc., G. H.	202
Lettime Radio Mfg. Co.	321
Linde Air Products Co., A Division of Union Carbide & Carbon Corp.	258
Litton Industries	187
Louthan Manufacturing Company	238

MaeDonald Co., Inc., W. S.	212
Mack Molding Company, Inc.	256
Magnecord, Inc.	266, 301
Mallory and Company, Inc., F. R.	80, 135
Marconi Instruments, Ltd.	308
Marion Electrical Instrument Co.	2
Markem Machine Company	260
McGraw-Hill Book Co., Inc.	168, 262, 331, 344
Melpar, Inc.	200
Mepeco, Inc.	58
Metal Textile Corporation	325
Metals & Control Corp., General Plate Division	203
Mica Insulator Company	34

FIRST WITH TEFLON*

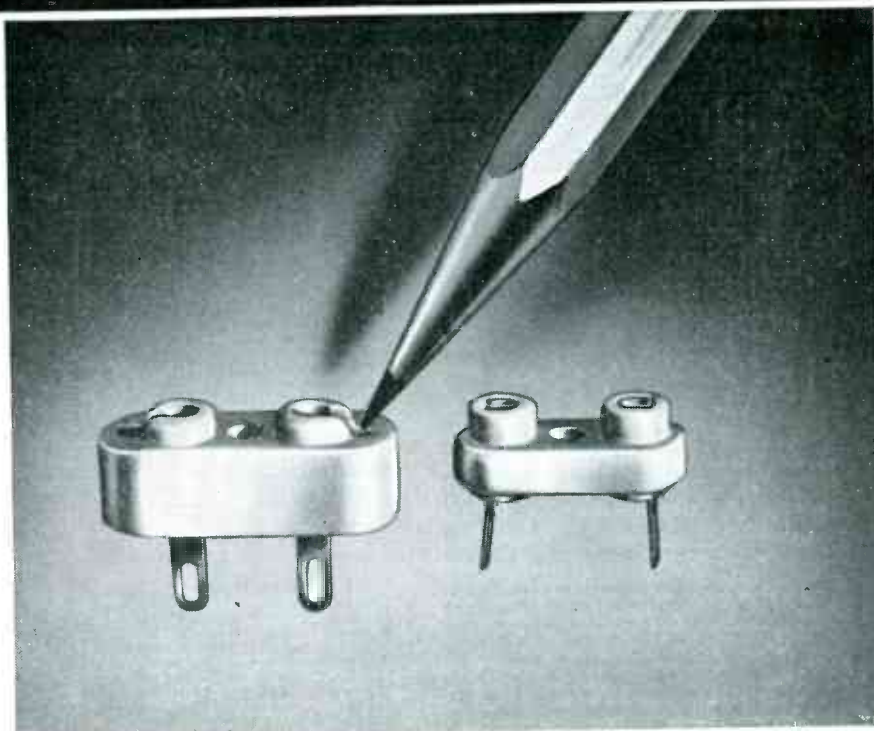

CHEMELEC Crystal Sockets

For low loss, frequency stability, and ability to take and absorb mechanical shock and vibration—specify Chemelec Crystal Sockets, made of TEFLON.

- Three sizes for use with holders having 0.050 pins spaced $\frac{1}{2}$ in., 0.095 pins spaced $\frac{1}{2}$ in. and 0.125 pins spaced $\frac{3}{4}$ in.
- Chemelec Crystal Sockets have a loss factor of less than 0.0005, a dielectric constant of 2.0 from 60 cycles to 30,000 megacycles.
- They are serviceable at temperatures from -150°F . to 500°F . with negligible change in electrical characteristics.
- Having zero water absorption, they are unaffected by extreme humidity.
- Chemically inert, they are immune to corrosive atmospheres, fungus, oil, solvents.
- Single hole mounted, by screw or rivet, they facilitate assembly as there is no danger of breakage as with ceramics.
- Write for bulletin No. CS 441

We also manufacture TEFLON sheets, rods, tubes and fabricated parts.

* du Pont's trademark for its tetrafluoroethylene resin

UNITED STATES GASKET COMPANY

FLUOROCARBON PRODUCTS DIVISION



600 N. 10TH STREET, CAMDEN, N.J.

FOREMOST FABRICATORS OF "TEFLON" AND OTHER FLUOROCARBON PLASTICS

Micro Instrument Co.	313, 344
Micro Switch, Div. of Minneapolis-Honeywell Regulator Co.	217
Miles Reproducer Co.	344
Miles Mfg. Co., Inc. James	219
Milo Radio & Electronics Corp.	27
Minneapolis-Honeywell Regulator Co., Industrial Div.	36, 37
Minnesota Mining & Mfg. Co.	42, 240
Mitchell-Rand Insulation Co., Inc.	23
Mosinee Paper Mills Company	228
Muirhead & Co., Ltd.	3
Mullard Overseas, Ltd.	211
Multicore Solders Ltd.	19
Mycalex Corp. of America	50

National Company, Inc.	330
National Moldite Co.	290
National Varnished Products Corp.	185
Neo-Sil Corp.	61
Newcomb Audio Products Co.	329
New Hampshire Ball Bearings, Inc.	234
New Hermes, Inc.	339
New York Transformer Co., Inc.	252
Niagara Radio Supply Corp.	335
North American Aviation, Inc.	160, 246
Nothelfer Winding Laboratories	323
Nucleonics	204
Numberall Stamp & Tool Co.	216

Ohmite Manufacturing Co.	32A, 32B
Onan & Sons, Inc., D. W.	341
O'Neill-Irwin Mfg. Co.	337
Oregon Electronics Mfg. Co.	176

Panoramic Radio Products, Inc.	386
Paper Machinery & Research, Inc.	188
Paramount Paper Tube Corp.	250
Patton-MacGyver Co.	310
Phalo Plastics Corporation	218
Phaotron Company	59
Phoenix Electronics, Inc.	184
Photocircuits Corporation	320
Pix Manufacturing Co., Inc.	304
Polarad Electronics Corporation	265
Potter & Brumfield	154
Potter Instrument Co., Inc.	274
Precision Apparatus Co., Inc.	388
Precision Paper Tube Co.	260
Presto Recording Corporation	39
Progressive Manufacturing Company	214
Pyramid Electric Co.	273

Quaker City Gear Works	321
------------------------	-----

Radio Cores, Inc.	250
Radio Corp. of America	159, 232, 293, Back Cover
Radio Receptor Company, Inc.	257
Radio Shack Corp.	296, 297
Radio Wire Television, Inc.	313
Railway Express Agency, Air Express Division	193
Rauland Corporation	249
Rawson Electrical Instrument Co.	323
Raytheon Manufacturing Co.	271, 305
Remler Company, Ltd.	328
Republic Foil & Metal Mills, Inc.	69
Resistoflex Corporation	311
Richardson Company	267
Runzel Cord & Wire Co.	310

Samco Products Company	317
Sangamo Electric Company	289
Scientific Electric Div. of "S" Corrugated	226
Seon Metals Corporation	333
Servo Corporation of America	230
Sessions Clock Company, Timer Div.	150
Shalleross Manufacturing Co.	70, 71
Signal Engineering & Mfg. Co.	258
Simpson Electric Company	76
Society of the Plastics Industry, Inc.	212
Sola Electric Company	189
Sorensen and Company, Inc.	17
Southwestern Industrial Electronics Co.	325
Specialty Battery Company	234
Sperry Gyroscope Co.	147
Sprague Electric Company	7
Stackpole Carbon Co.	153
Stahl, Inc., Michael	262
Standard Electric Time Co.	183
Standard Piezo Company	306
Standard Telephones & Cables, Ltd.	184
Standard Transformer Corp.	146
Star Porcelain Company	326
Staver Company, Incorporated	333
Stevens Mfg. Co., Inc., Geo.	200
Steward Manufacturing Co., D. M.	26
Stoddart Aircraft Radio Co.	286
Stokes Machine Co., E. J.	195
Stupakoff Ceramic & Mfg. Company	199
Superior Electric Co.	60
Superior Steatite & Ceramic Corp.	226

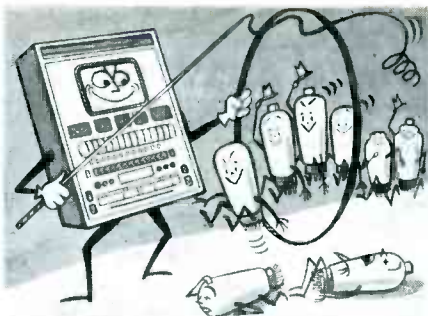

You Get **OVERALL** Test Performance With

PRECISION- SERIES 10-12 Electronamic

TUBE PERFORMANCE TESTER
with 12 ELEMENT free-point
Master Lever Selector System

To test modern tubes for only one characteristic will not necessarily reveal overall performance capabilities. Tube circuits look for more than just Mutual Conductance or other single factor.

In the Precision Electronamic Circuit, the tube PERFORMS under appropriately phased and selected individual element potentials, encompassing a wide range of plate family characteristic curves. This complete Path of Operation is integrated by the indicating meter in the positive PERFORMANCE terms of Replace-Weak-Good.

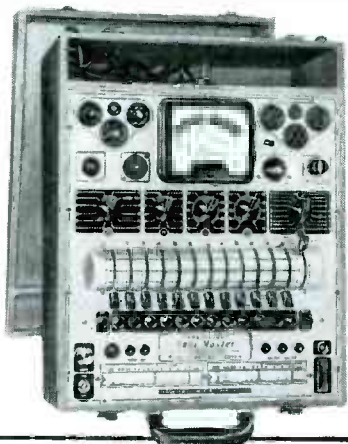

MODEL 10-12-P: in sloping, portable hardwood case with tool compartment and hinged removable cover. Size 13 $\frac{3}{4}$ x 17 $\frac{1}{4}$ x 6 $\frac{3}{4}$ "... **\$101.75**
Also in counter or rack-panel mounts.

- ★ Facilities to 12 element prongs.
- ★ Filament voltages from $\frac{1}{4}$ to 117 volts.
- ★ Tests Noval 9 pins; 5 and 7 pin acorns; double-capped N.F. amplifiers; low power transmitting tubes; etc. REGARDLESS OF FILAMENT OR ANY OTHER ELEMENT PIN POSITIONS.
- ★ ISOLATES EACH TUBE ELEMENT REGARDLESS OF MULTIPLE PIN POSITIONS.
- ★ DUAL short check sensitivity for special purpose tube selection.
- ★ Battery Tests under dynamic load conditions.
- ★ Built-in Dual-Window, brass-gear roller chart.
- ★ 4 $\frac{1}{2}$ " Full Vision Meter.

SEE the "Precision" Electronamic Tube Tester at leading radio equipment distributors. Write for new 1952 catalog describing Precision Test Equipment for all phases of modern electronics.

Precision Apparatus Co., Inc.

92-27 HORACE HARDING BLVD. • ELMHURST 10, N. Y.

*Reg. U.S. Patent Office

Export: 458 B'way, N.Y.C., U.S.A. Cables: MORHANEX
In Canada: Atlas Radio Corp. Ltd., Toronto, Ontario

Superior Tube Company 155
Swift & Sons, M. 302
Sylvania Electric Products, Inc. 5, 245
Syntron Co. 308

Taylor Tubes, Inc. 322
Tech Laboratories, Inc. 323
Technology Instrument Corp. 278
Tektronix, Inc. 280
Teletronics Laboratory, Inc. 258, 344
Telex, Electro-Acoustic Division 302
Tenney Engineering, Inc. 264
Thomas & Skinner Steel Products Co. 194
Tinnerman Products, Inc. 169
Transco Products, Inc. 210
Transcoil Corporation 299
Transradio, Ltd. 254
Turner Company 178

Uemite Co. 243
Union Carbide & Carbon Corp.,
Linde Air Products Div. 258
United Condenser Corp. 335
United States Gasket Company 387
United Transformer Co. Second Cover
Universal Chain Co., Inc. 188

Veeder-Root, Inc. 237
Victoreen Instrument Company 180
Vulcan Electric Company 329

Waldes Kohinoor, Inc. 75
Ward Products Corp. 162
Warren Wire Company 208
Waterman Products Co., Inc. 238
Western Gold & Platinum Works 204
Westinghouse Electric Corp. 172, 213
Weston Electrical Instrument Corp. 197
Wheeler Insulated Wire Co., Inc. 158, 329
White Dental Mfg. Company, S. S. 172, 238
Whitehead Stamping Company 327
Willcox Electric Company 67
Williams & Co., C. K. 294
Wilton Tool Mfg. Co. 315
Winchester Electronics Incorporated 338
Workshop Associates, Inc. 30, 335

Zophar Mills, Inc. 341

PROFESSIONAL SERVICES 343

SEARCHLIGHT SECTION (Classified Advertising)

H. E. HILTY - Mgr. 341

EMPLOYMENT

Positions Vacant 345-352
Positions Wanted 345
Selling Opportunities Wanted 345

EQUIPMENT

(Used or Surplus New)
For Sale 352-384

WANTED

Equipment 352-384

ADVERTISERS INDEX

Allied Electronics Sales 372
American Electrical Sales Co. 382
Arma Corporation 351
Arrow Sales, Inc. 378
Bary Electronics Corp. 369
Bendix Aviation Corp. 348
Berkeley Scientific Corp. 350
Blan 370
C & H Sales Co. 371, 382
Capehart-Farnsworth Corp. 346
Carol Distributing Co. 382

Chase Electronics Supply Co. 373
Chicago Midway Laboratories 352
Circle Sales Corp. 352
Columbia Electronics, Ltd. 368, 382
Compass Communications Co. 374
Communication Devices Co. 381
Communications Devices Co., Inc. 378
Communications Equipment Co. 363, 365
Convair 345
Cornell-Aeronautical Laboratory, Inc. 350
Cottone & Co., A. 375
Credda, Inc. 370
Dorne & Margolin 352
Eastern Telephone Co. 382
Edlie Electronics Inc. 379
Electro Impulse Laboratory 368
Electro Sales Co. 381
Electronic Engineering Co. of Calif. 346
Electronic Expeditors 379
Electronic Spec. Supply Co. 370
Electroncraft, Inc. 357
Empire Electronics Co. 376
Forest Sales Co., Inc. 375
Freeland Products Co. 371
General Electric Company 346
General Motors Corp., AC Spark Plug Div. 350
Goodyear Aircraft Corp. 347
Green, Gould 372
Hall Electric Ltd. 374
Harmar Co., The 372
Hastings Instruments Co. 349
I. B. M. 348
Instruments Associates 360
J. S. H. Sales Co. 376
Kent Engineering Co. 382
Key Electronics Div. 377
Kings County Machinery Exchange 372
Lapirow Bros. 378
Lectronic Research Laboratories 354
Leru Laboratories Inc. 373
Liberty Electronics, Inc. 362
Limozaime, J. C. 378
Lockheed Aircraft Corp. 349
Lowenthal Co., T. R. 378
Maritime International Co. 376
Maritime Switchboard 377
Maxson Corp., The W. L. 348
Metropolitan Overseas Supply Corp. 381
Minneapolis-Honeywell Regulator Co. 349
Mogull Co., Inc., Alexander 369
Monmouth Radio Laboratories 381
Monsanto Chemical Co. 346
Motorola, Inc. 351
Norman Radio Distributors, Inc. 376
Northrop Aircraft, Inc. 348
Pace Electronics 379
Photocon Sales 378
Powell, Harold H. 375
Precision Electrical Instrument Co. 370
Radio Development & Sales Co. 352
Radio & Electronic Surplus 378
Radio Ham Shack, Inc. 358
Radio Surplus Corp. 364
Reeves Instrument Corp. 351
Reliance Merchandising Co. 353
Role Electronics Inc. 381
Sandia Corp. 347
Servo-Tek Products Co., Inc. 361
Sperry Products Inc. 350
Sylvania Electric 357
Tab 383, 384
Technical Radio Parts Co. 382
Telemarine Communications Co. 366
Terminal Radio 367
Tung-Sol Electric Inc. 351
Universal General Corp. 359
Universal Marine & Mfg. Corp. 377
University of Chicago 372
V & H Radio & Electronic Supply Co. 371
Wells Sales, Inc. 356
Weston Laboratories 370
Wilcox Electric Co. 352
Wilgreen Industries 373

This Index is published as a convenience to the readers. Every care is taken to make it accurate, but ELECTRONICS assumes no responsibility for errors or omissions.

magnetrons?

PULSE • TUNABLE • CW

you
can
depend
upon

AMPEREX

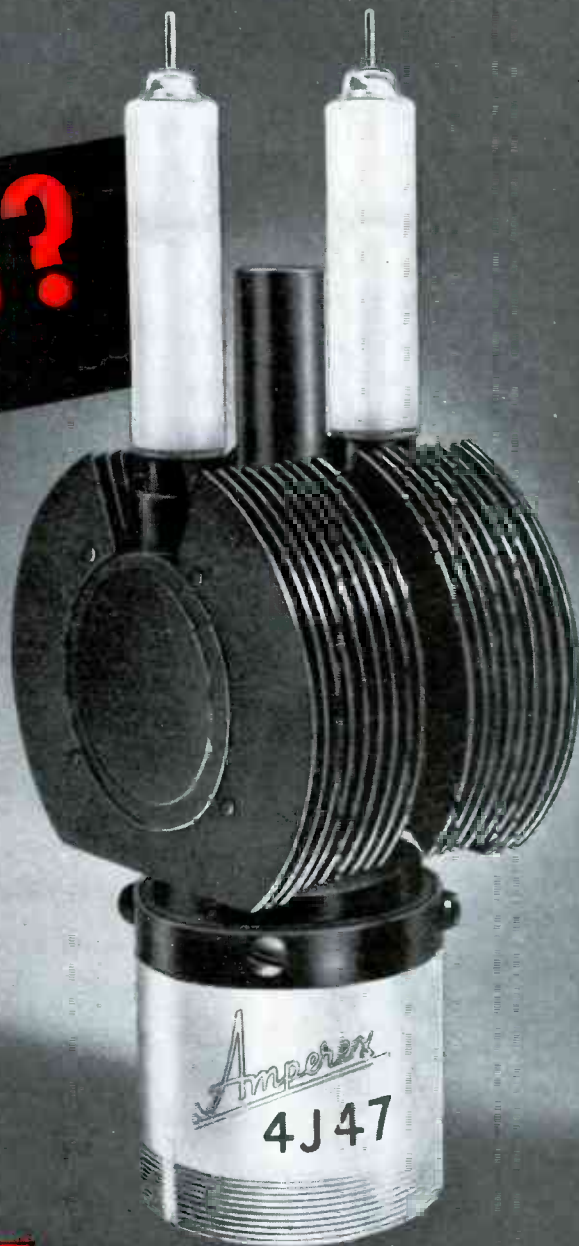

Specialists in the design and construction of all types of electron tubes for civilian and military applications... and recognized as one of the oldest, largest and finest organizations in the whole world.

With laboratory and production facilities that are second to none, we draw a wealth of experience from extensive development files compiled by our engineering staff and their predecessors since 1896.

May we serve you?

AMPEREX ELECTRONIC CORP.



*Our Newest Plant
Hicksville, New York*

25 WASHINGTON STREET, BROOKLYN 1, N. Y.
In Canada and Newfoundland: Canadian Radio & Mfg. Co.
11-19 Brentcliffe Road, Leaside, Toronto, Ontario, Canada
Cable: "AMPRONICS"

UHF-TV



TYPICAL TV POWER AMPLIFIER OPERATING CONDITIONS

Grounded-Grid Circuit, at 900 Mc. with
6.0 Mc. Band Width for Class B and
Grid-Modulated Class C Service

DC Plate Voltage	1500 volts
Peak RF Grid Voltage	735 volts
DC Plate Current	
Synchronizing Level	0.350 amp.
DC Grid Current	
Synchronizing Level	0.030 amp.
Driver Power Output (Approx.)	
Synchronizing Level	75 [*] watts
Output Circuit Efficiency	65%
Useful Power Output	
Synchronizing Level	200 [†] watts

*This value includes 18 watts of RF circuit loss and 40 watts of RF power added to the plate input.

†This value of useful power is measured at load of output circuit having indicated efficiency.

Another RCA First... **RCA-6161 forced-air cooled power triode for UHF services up to 2000 Mc.**

Featuring forced-air cooling, and a coaxial-electrode structure, the new RCA-6161 is particularly suited to grounded-grid operation in circuits of the coaxial-cylinder type. In addition to its use as a power amplifier in UHF television transmitters, the RCA-6161 may be employed as an RF amplifier or frequency multiplier in Class C telegraphy and telephony at frequencies up to 2000 Mc.

The RCA-6161 has a maximum plate dissipation of 250 watts in CW or TV applications, and can be operated at full plate voltage and plate input at frequencies as

high as 900 Mc... and at reduced ratings up to 2000 Mc.

The RCA-6161 is of the heater-cathode type, the heater drawing 3.4 amperes at 6.3 volts. The coaxial-electrode structure provides low inductance, large-area RF electrode terminals, and permits effective isolation of plate and cathode.

For complete technical data on the RCA-6161, write RCA, Commercial Engineering, Section BR42, Harrison, N. J., or your nearest RCA field office.

FIELD OFFICES: (East) Humboldt 5-3900, 415 S. 5th St., Harrison, N. J. (Midwest) Whitehall 4-2900, 589 E. Illinois St., Chicago, Ill. (West) Madison 9-3671, 420 S. San Pedro St., Los Angeles, Calif.

Another new RCA tube

RCA-6080 Twin Power Triode, intended for use as a regulator tube in dc power supplies. Similar to 6AS7-G, but with improved resistance to shock and vibration.



THE FOUNTAINHEAD OF MODERN TUBE DEVELOPMENT IS RCA



RADIO CORPORATION of AMERICA

ELECTRON TUBES

HARRISON, N. J.